



PT.AVERON

— GLOBAL INDONESIA —

IMPORTER & SUPPLIER OF MEDICAL INSTRUMENTS



Surgical Forceps





 www.averonindonesia.com

SURGICAL FORCEPS

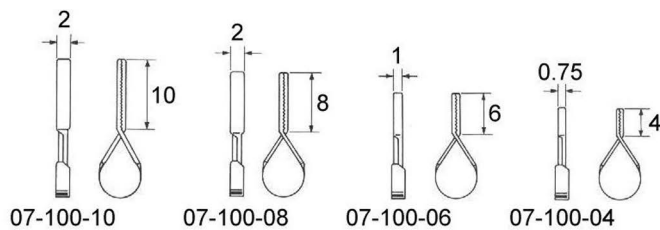

SURGICAL FORCEPS



	Length of Jaw	10 mm
	Width of Jaw	2 mm
1/1 07-100-10		
	Length of Jaw	8 mm
	Width of Jaw	2 mm
1/1 07-100-08		
	Length of Jaw	6 mm
	Width of Jaw	1 mm
1/1 07-100-06		
	Length of Jaw	4 mm
	Width of Jaw	0.75 mm
1/1 07-100-04		

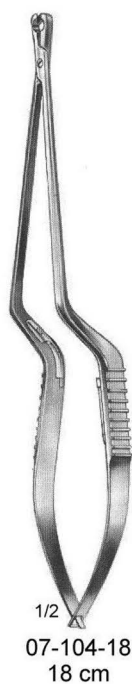
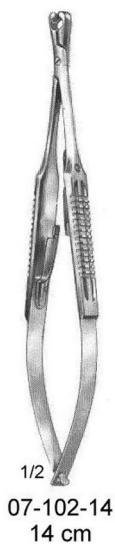

SURGICAL FORCEPS



07-108-10 - 07-109-18

	07-108-10	07-108-14	07-108-18	07-109-10	07-109-14	07-109-18
Length	31 mm	35 mm	39 mm	30 mm	33 mm	36 mm
Jaws	10 mm	10 mm	10 mm	10 mm	10 mm	10 mm

SURGICAL FORCEPS



Dieffenbach

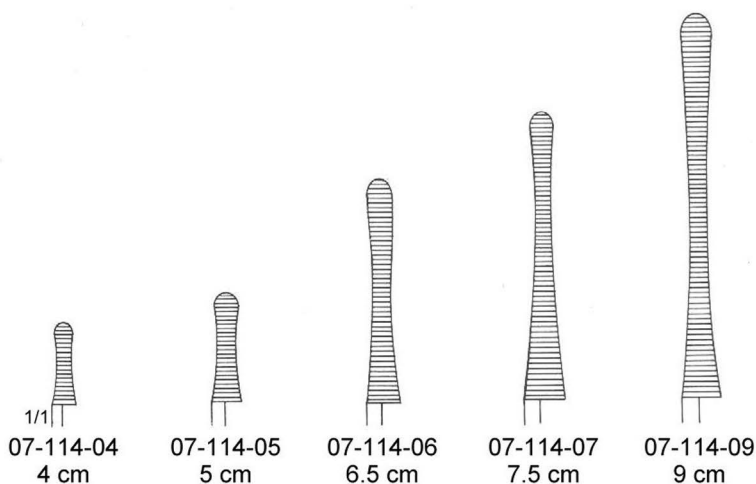
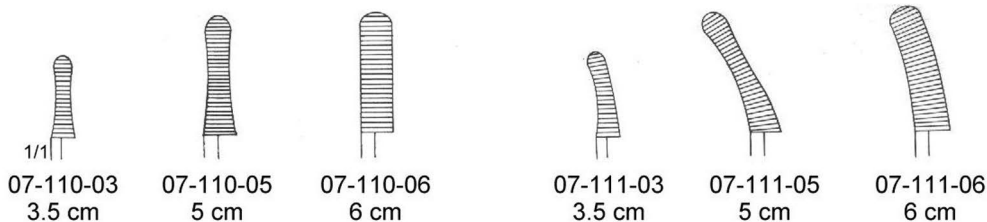

Johns Hopkins

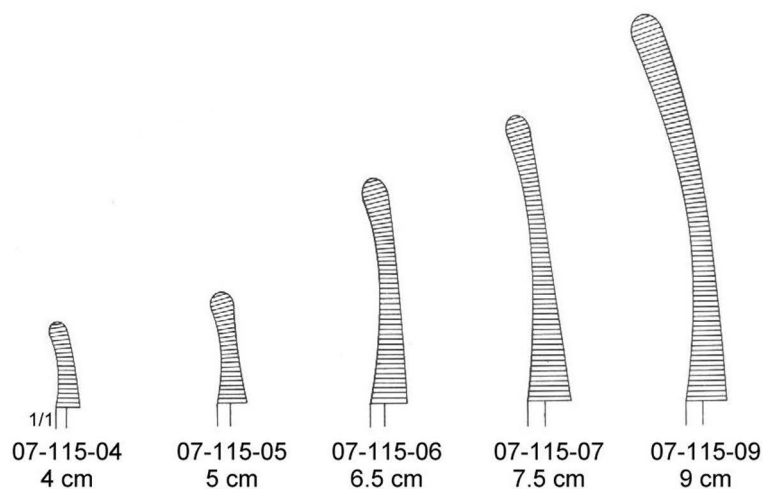

SURGICAL FORCEPS



Diethrich
07-120-08 - 07-121-12

Length
Jaws

Model	Length	Jaws
07-120-08	50 mm	8 mm
07-120-10	50 mm	12 mm
07-120-12	60 mm	20 mm

Model	Length	Jaws
07-121-08	50 mm	8 mm
07-121-10	50 mm	12 mm
07-121-12	60 mm	20 mm

Atrauma



DeBakey - Diethrich
07-124-10 - 07-125-20

Model	Length	Jaws
07-124-10	50 mm	10 mm
07-124-14	50 mm	14 mm
07-124-20	60 mm	20 mm

Model	Length	Jaws
07-125-10	50 mm	10 mm
07-125-14	50 mm	14 mm
07-125-20	60 mm	20 mm

SURGICAL FORCEPS

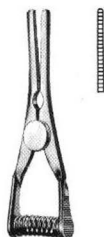

3 cm

Vena 07-130-30
Arteria 07-140-30

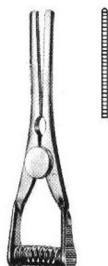

3.5 cm

07-130-35
07-140-35

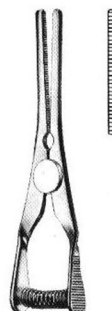

4 cm

07-130-40
07-140-40



5 cm

07-130-50
07-140-50



3 cm

Vena 07-131-30
Arteria 07-141-30

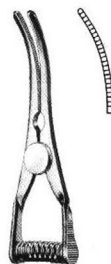

3.5 cm

07-131-35
07-141-35

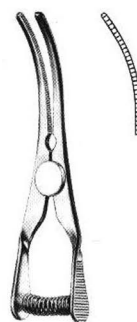

4 cm

07-131-40
07-141-40

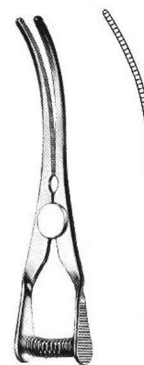

5 cm

07-131-50
07-141-50



3 cm

Vena 07-133-30
Arteria 07-143-30

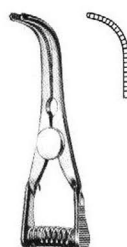

3.5 cm

07-133-35
07-143-35

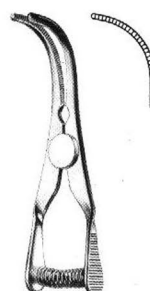

4 cm

07-133-40
07-143-40

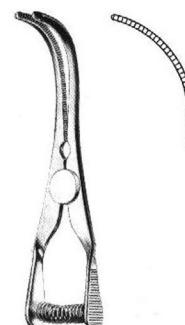

5 cm

07-133-50
07-143-50

SURGICAL FORCEPS

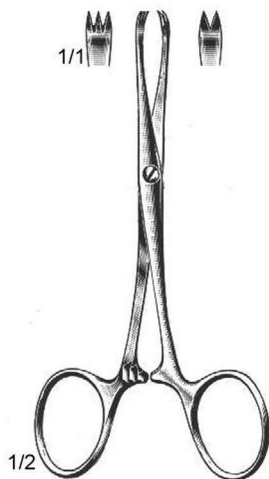

Chaput
07-140-13
13 cm
2:3 Teeth

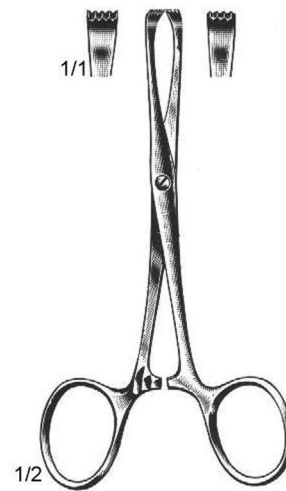

Tuffier
07-142-13
13 cm
4:5 Teeth

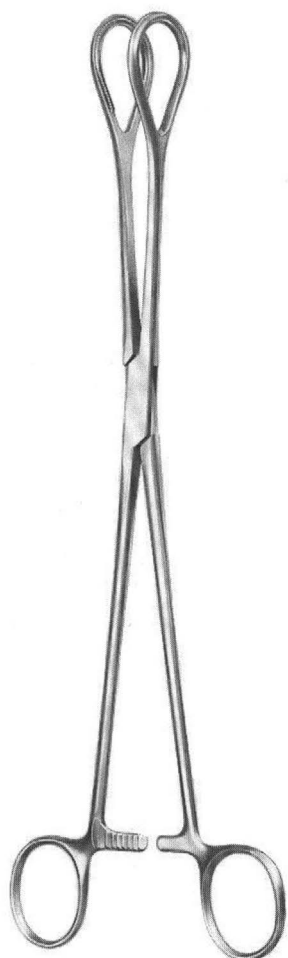

Atrauma



07-146-25
25 cm



07-146-26
26 cm

07-146-25 - 07-146-26

SURGICAL FORCEPS

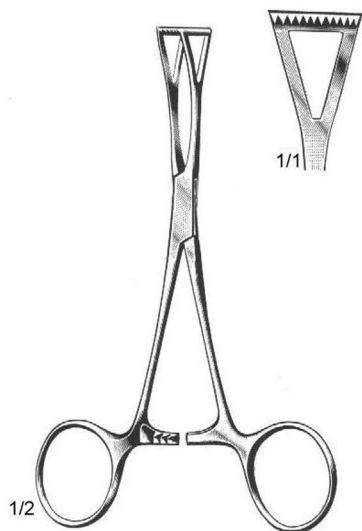

Collin
07-150-14
14 cm

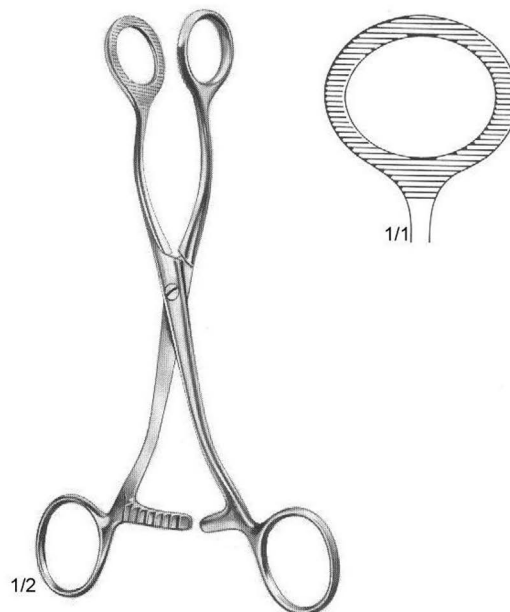

Collin
07-152-16
16.5 cm

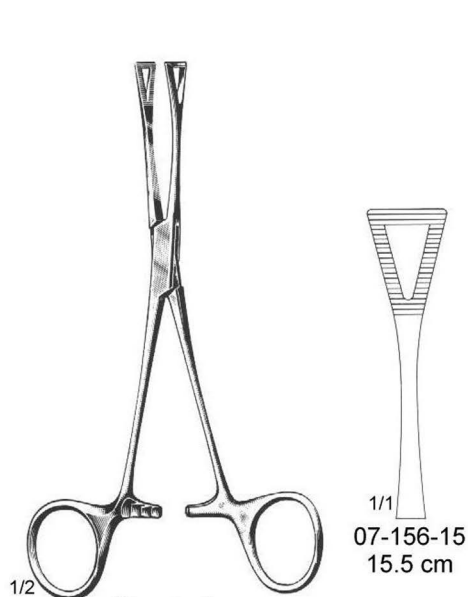

Pennington
07-156-15 - 07-156-20

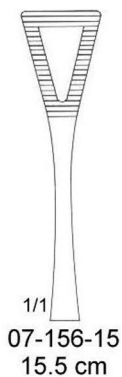

07-156-15
15.5 cm



07-156-20
20 cm



Pratt
07-158-15
15 cm

SURGICAL FORCEPS

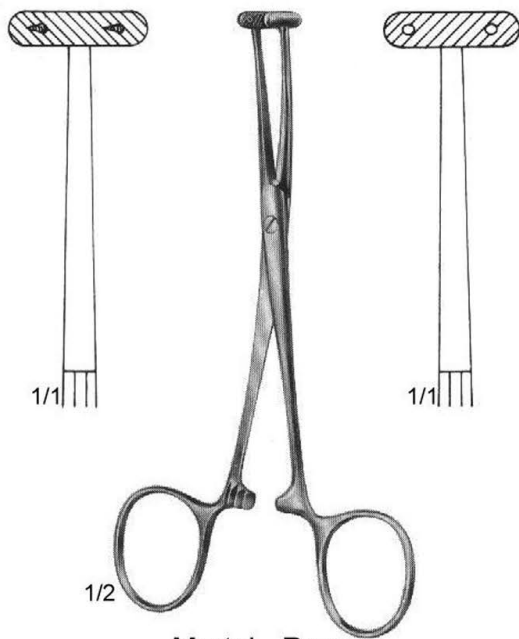

Martel - Rees
07-160-14
14 cm

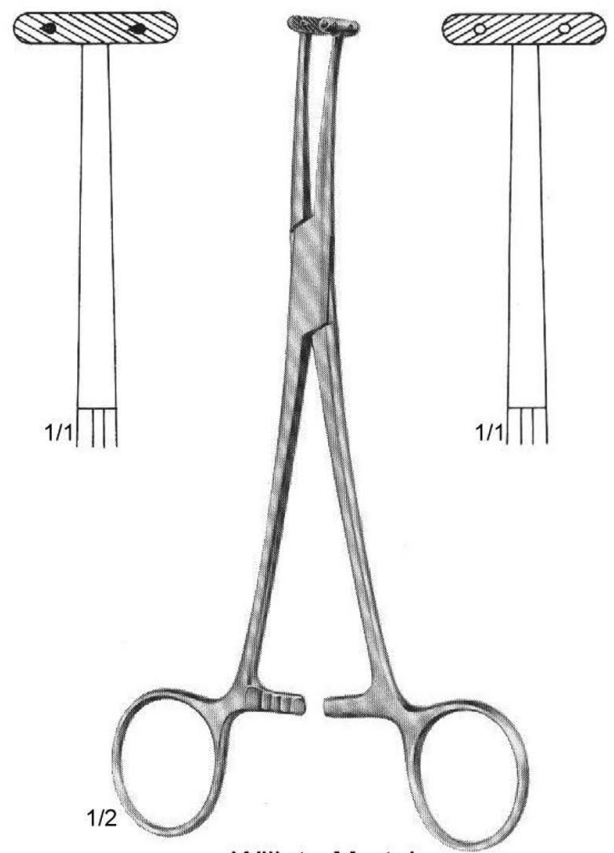

Willet - Martel
07-160-19
19 cm

SURGICAL FORCEPS

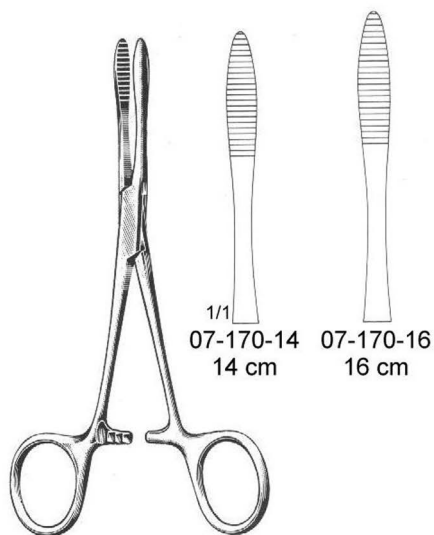

1/1
07-170-14 14 cm
07-170-16 16 cm

Pean
07-170-14 - 07-170-16

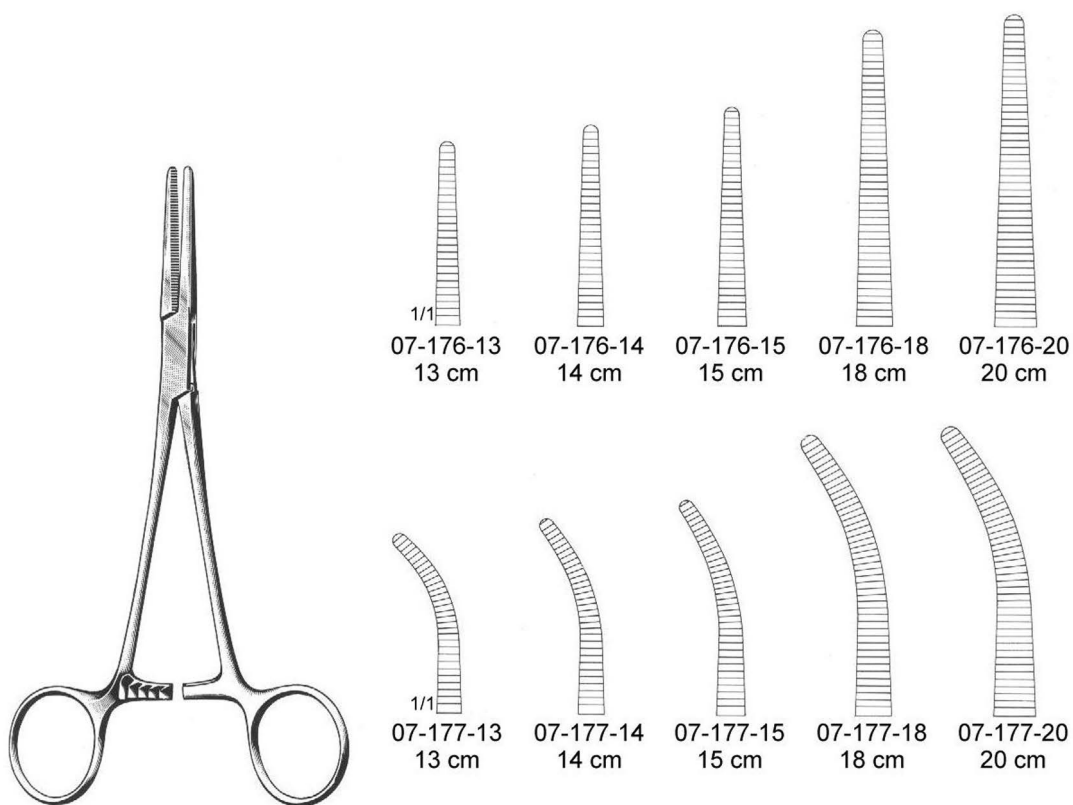

1/1
07-176-13 13 cm
07-176-14 14 cm
07-176-15 15 cm
07-176-18 18 cm
07-176-20 20 cm

1/1
07-177-13 13 cm
07-177-14 14 cm
07-177-15 15 cm
07-177-18 18 cm
07-177-20 20 cm

Spencer - Wells
07-176-13 - 07-177-20



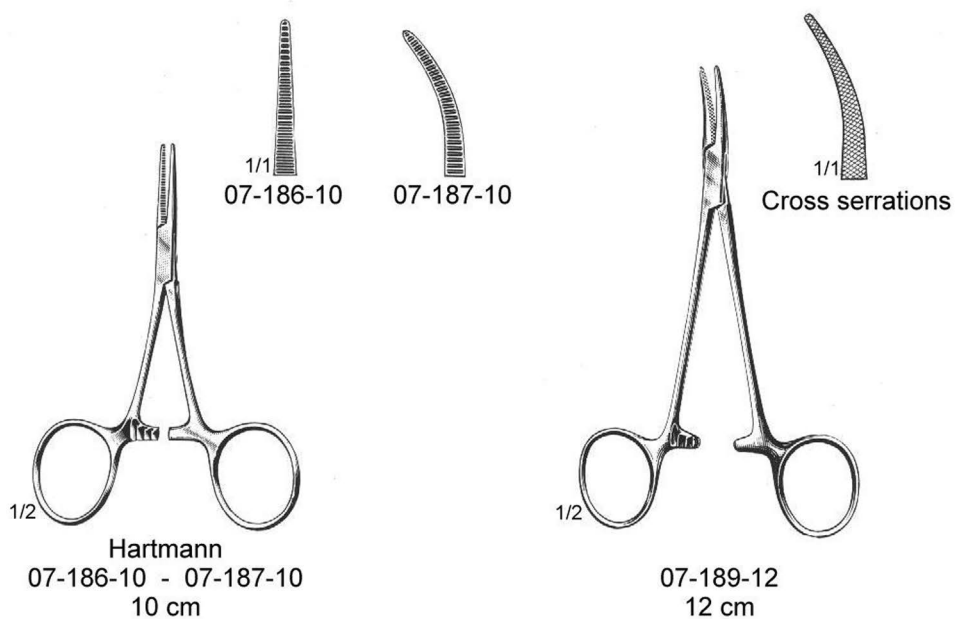
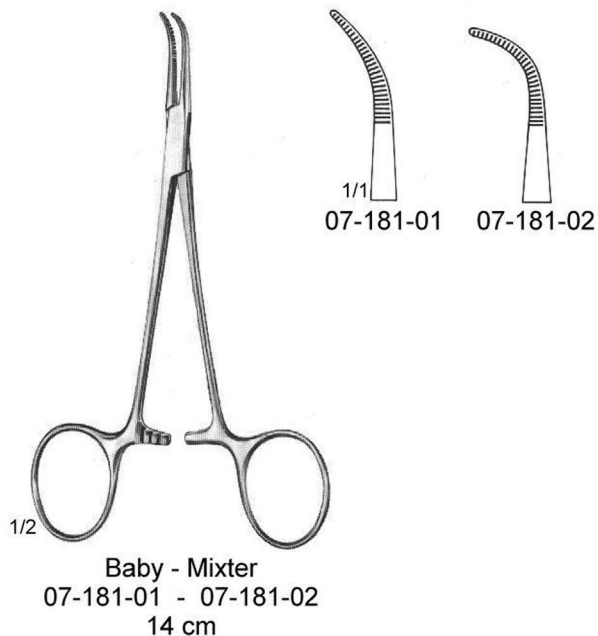



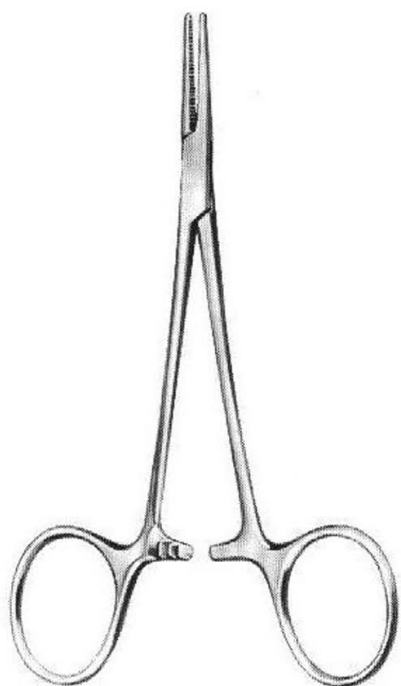

SURGICAL FORCEPS

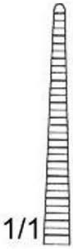

SURGICAL FORCEPS

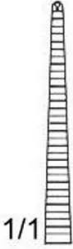

Halsted - Mosquito
07-190-12 - 07-193-14

 1/1 07-190-12 12.5 cm	 07-190-14 14 cm	 07-191-12 12.5 cm	 07-191-14 14 cm
 1/1 07-192-12 12.5 cm 1:2 Teeth	 07-192-14 14 cm 1:2 Teeth	 07-193-12 12.5 cm 1:2 Teeth	 07-193-14 14 cm 1:2 Teeth

SURGICAL FORCEPS



Halsted - Mosquito
07-200-18 - 07-203-21

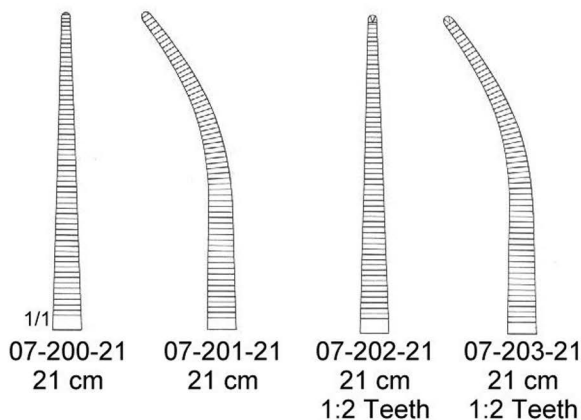
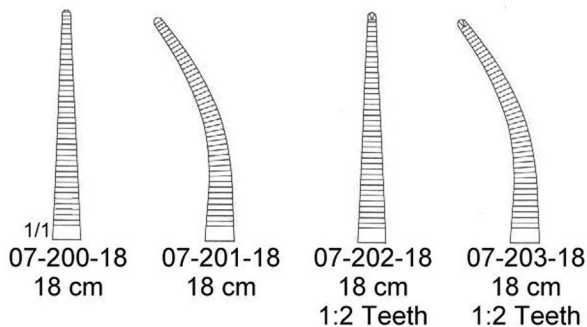

Micro - Mosquito
07-210-10 - 07-213-12

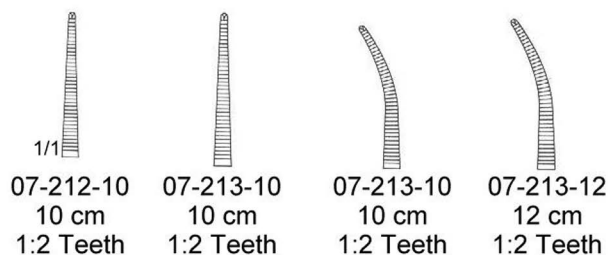
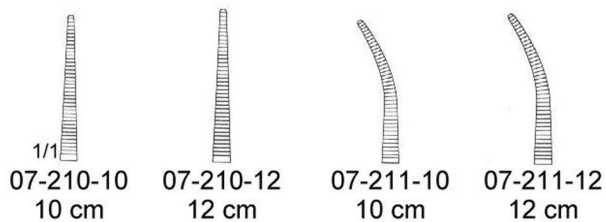

SURGICAL FORCEPS

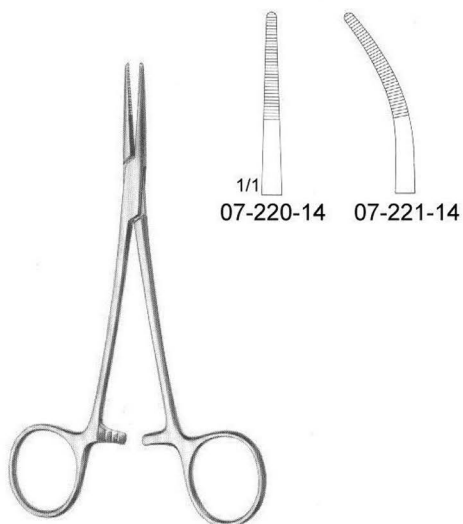

Providence - Hospital
07-220-14 - 07-221-14
14 cm

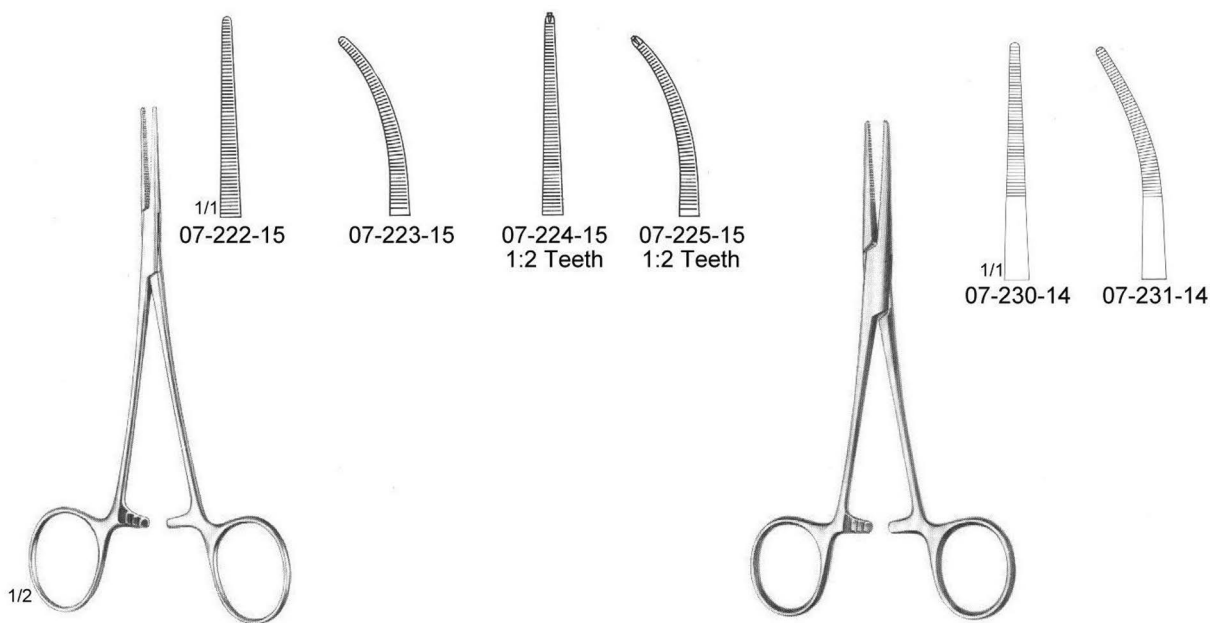

Leriche
07-222-15 - 07-225-15
15 cm



Kelly
07-230-14 - 07-231-14
14 cm

SURGICAL FORCEPS

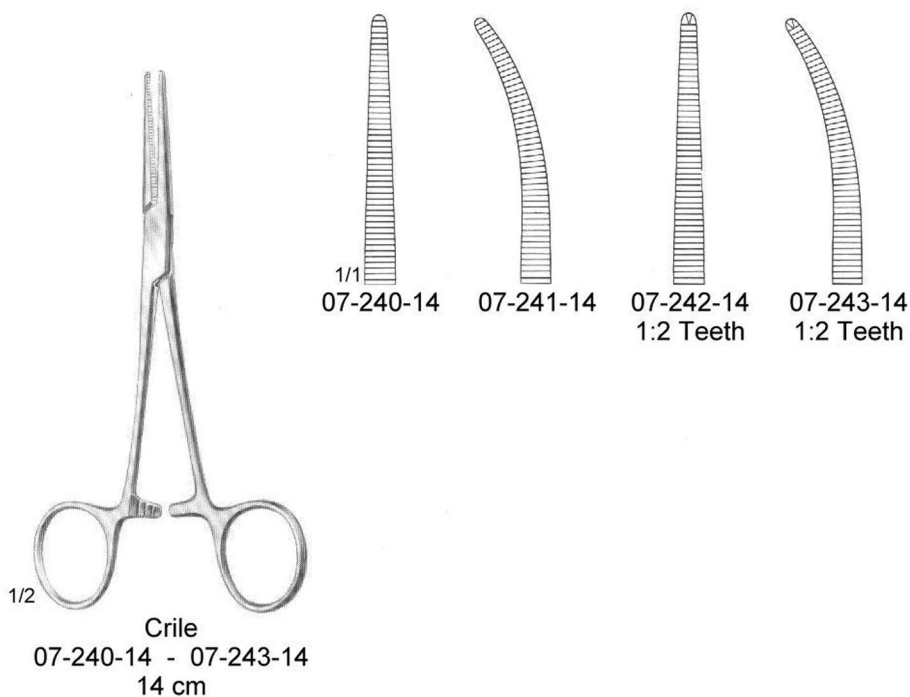
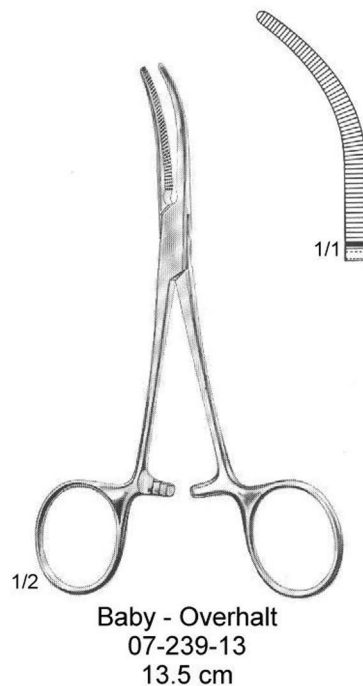
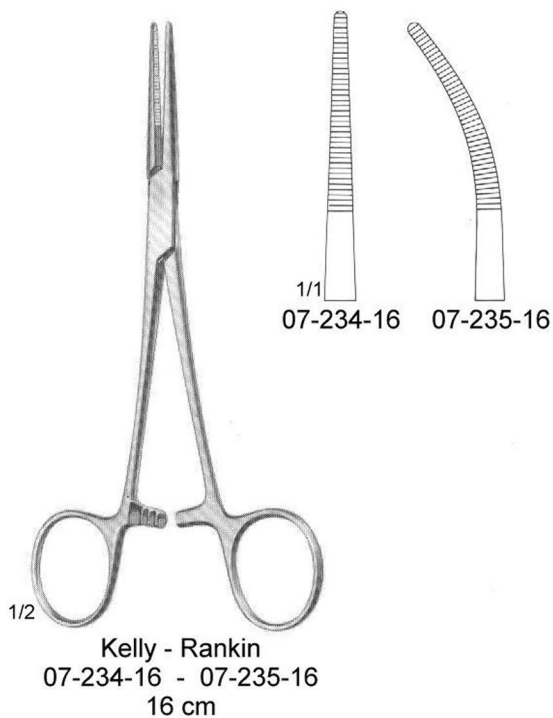

SURGICAL FORCEPS

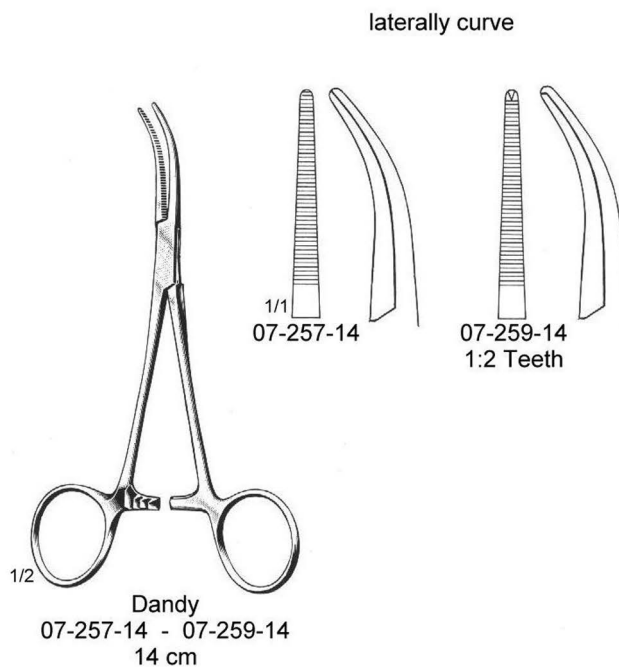
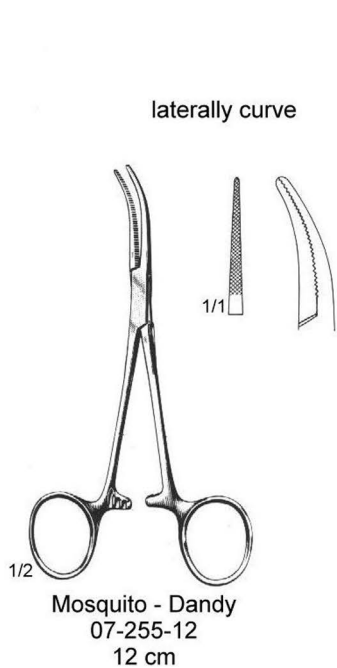
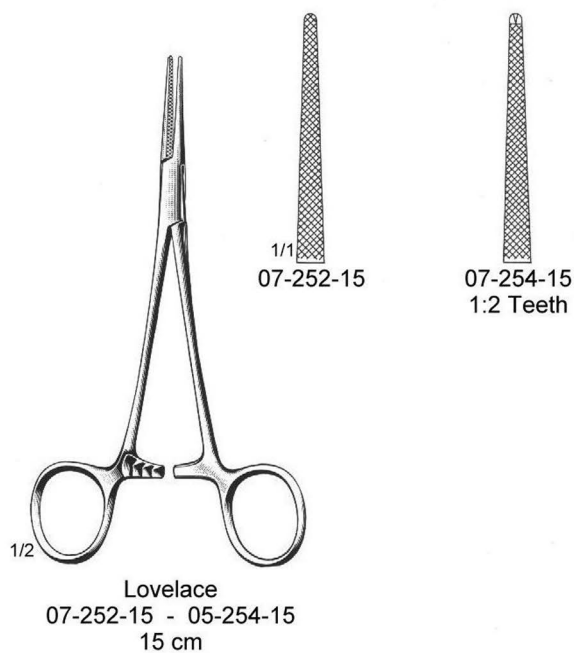
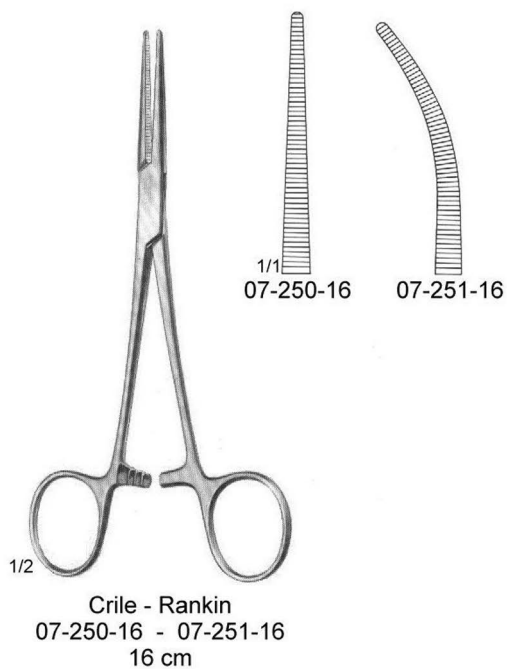

SURGICAL FORCEPS

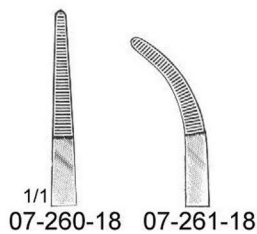
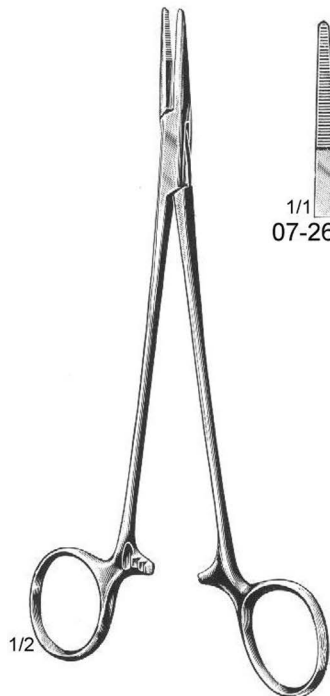

Adson
07-260-18 - 07-261-18
18.5 cm

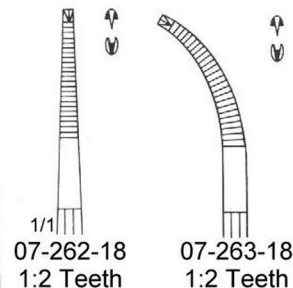

Adson
07-262-18 - 07-263-18
18.5 cm

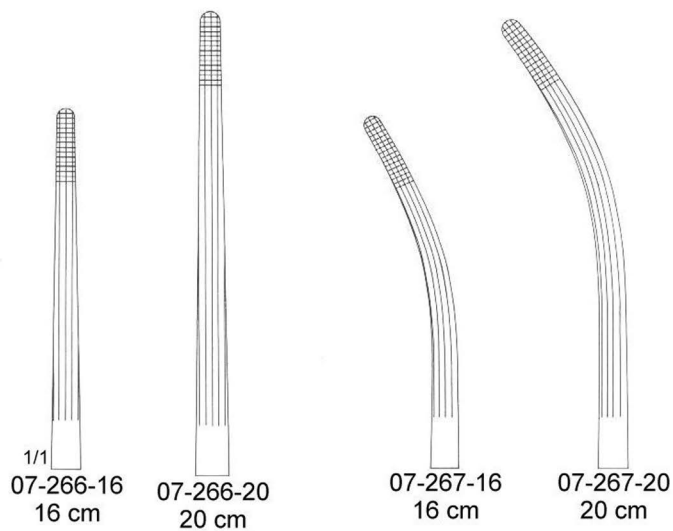

Rochester - Carmalt
07-266-16 - 07-267-20

SURGICAL FORCEPS

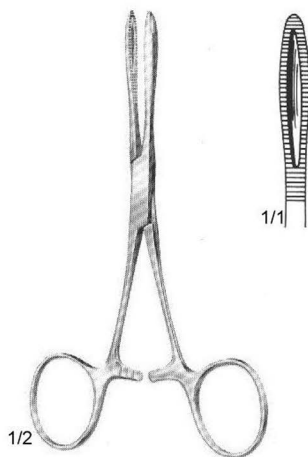

Kroenlein
07-270-13
13 cm

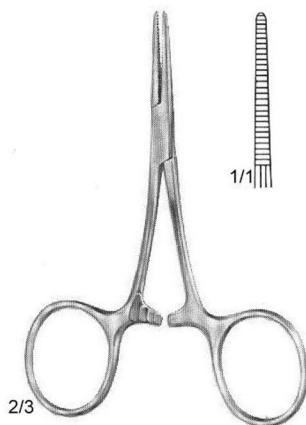

Carrel
07-272-08
8.5 cm

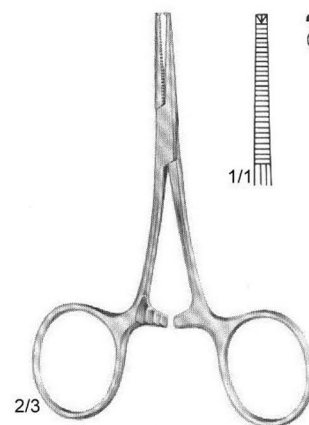

Terrier
07-274-08
8.5 cm
1:2 Teeth

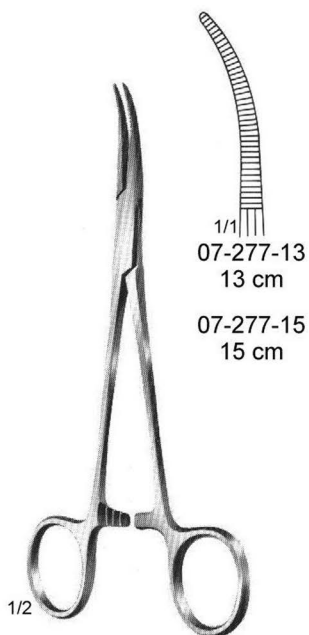

Christophe
07-277-13 - 07-277-15

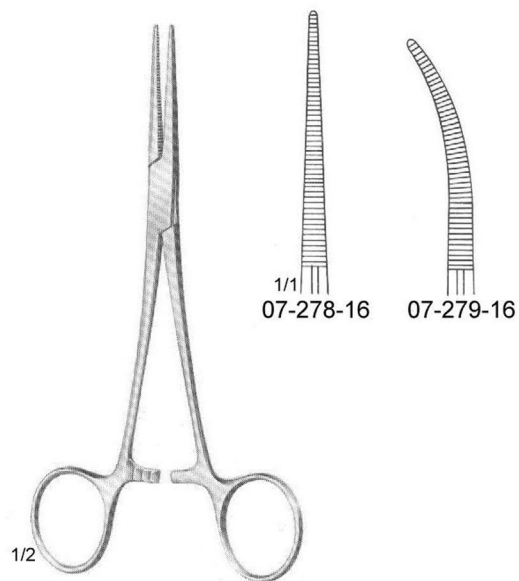

Coller
07-278-14 14 cm 07-279-14
07-278-16 16 cm 07-279-16

SURGICAL FORCEPS



Pean
07-280-13 - 07-281-16
Delicate pattern

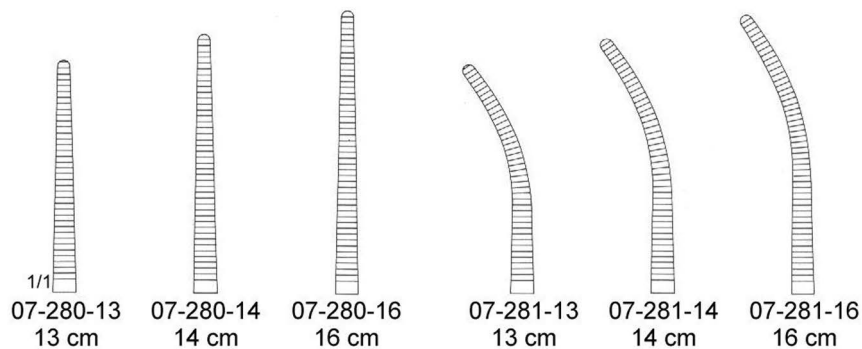

Kocher
07-286-13 - 07-287-16
Delicate pattern
1:2 Teeth

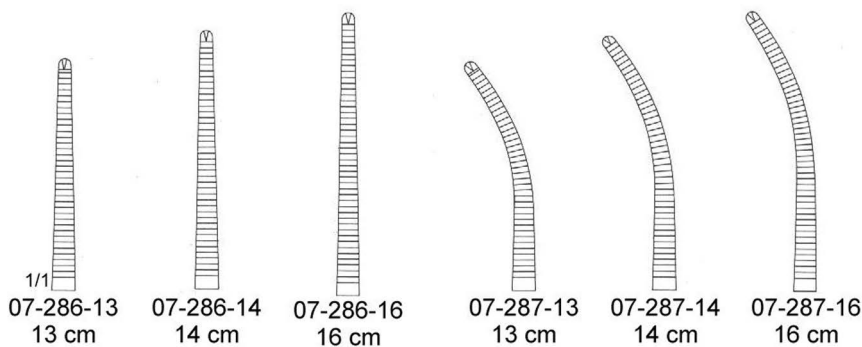

SURGICAL FORCEPS



Pean - Nippon
07-290-14 - 07-291-18

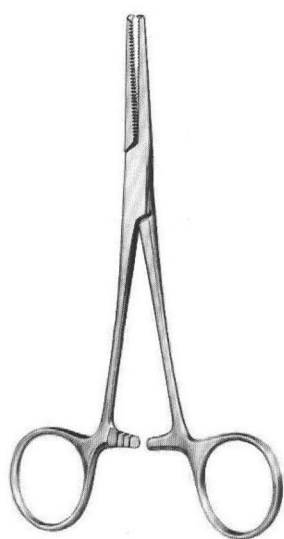
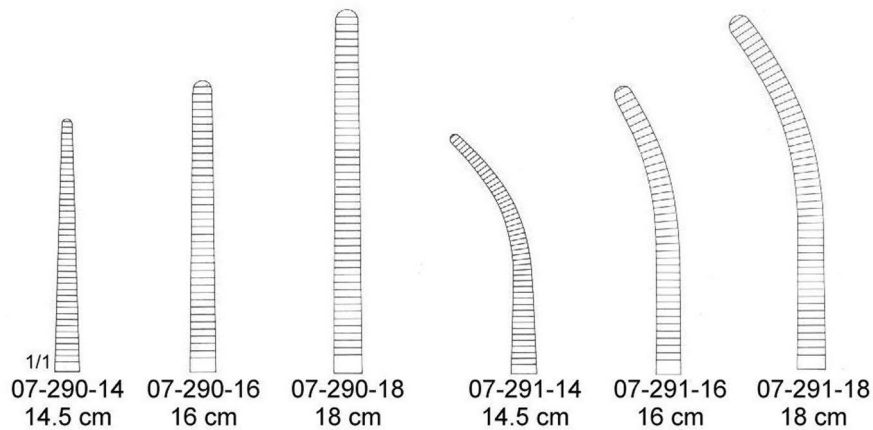

Kocher - Nippon
07-296-14 - 07-297-18
1:2 Teeth

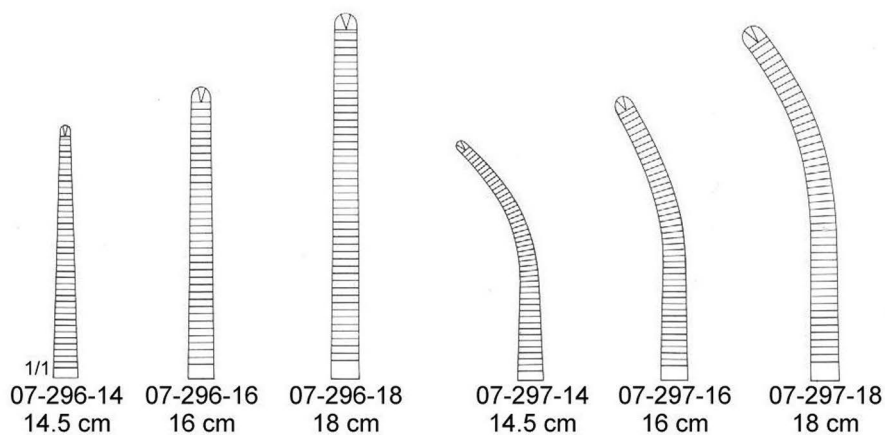

SURGICAL FORCEPS



Bengolea
07-300-20 - 07-303-26

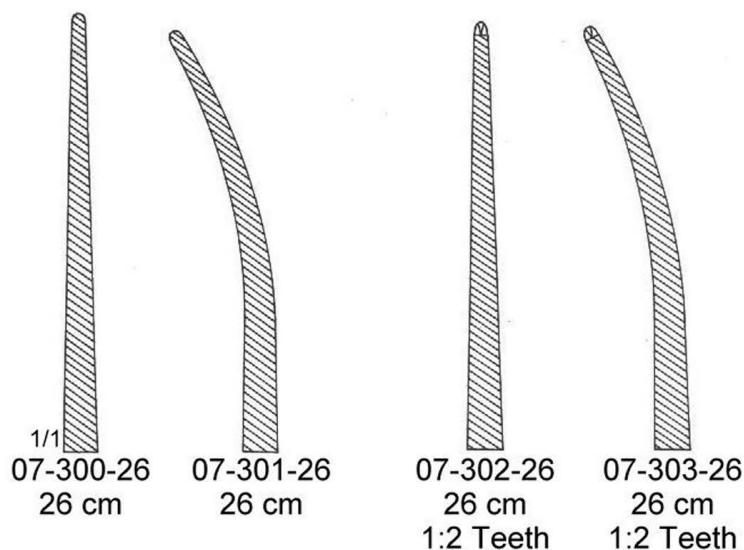
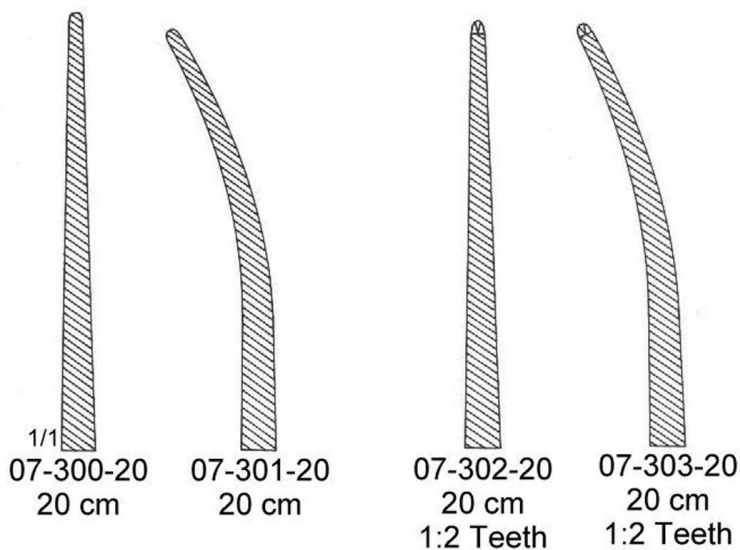

SURGICAL FORCEPS

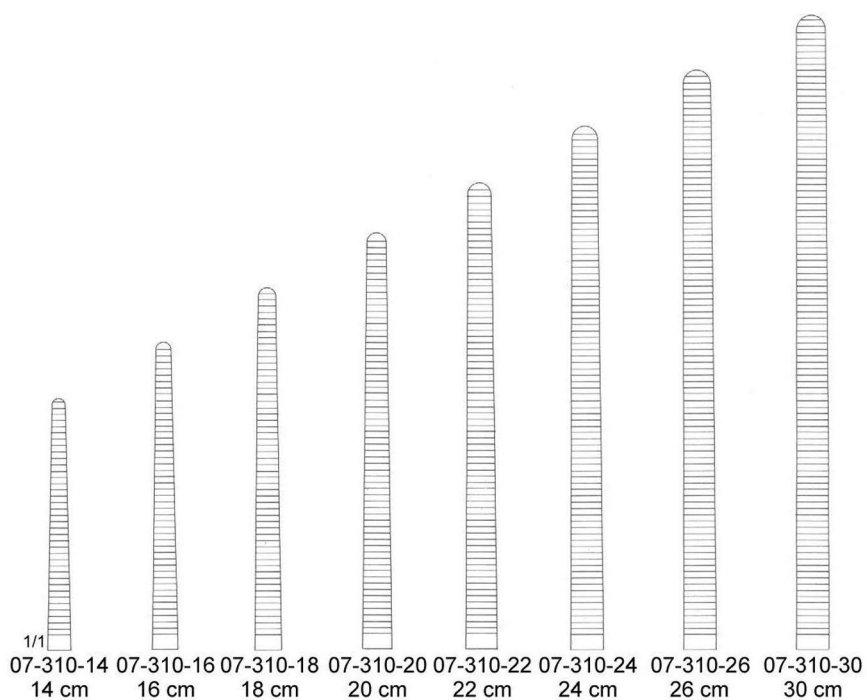

Rochester Pean
07-310-14 - 07-311-30

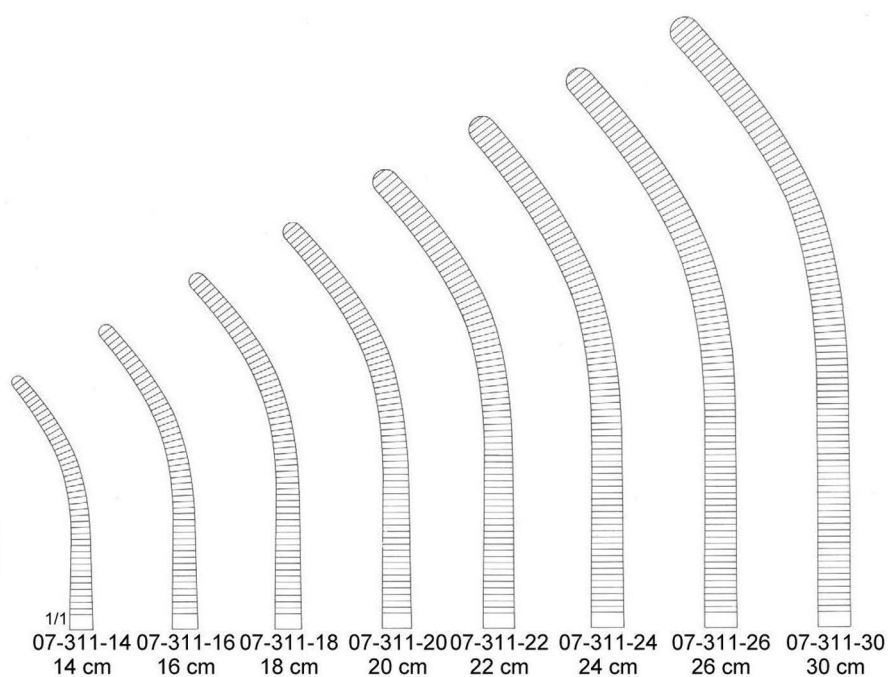

SURGICAL FORCEPS

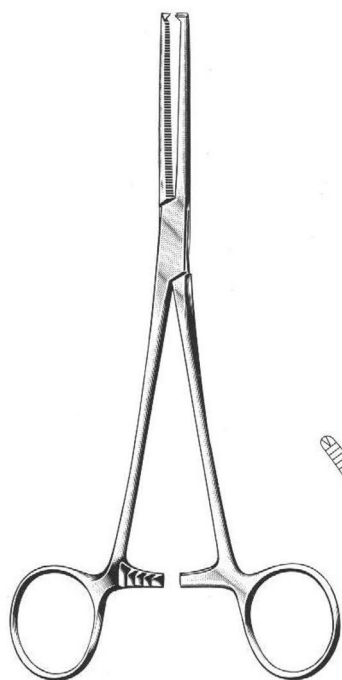
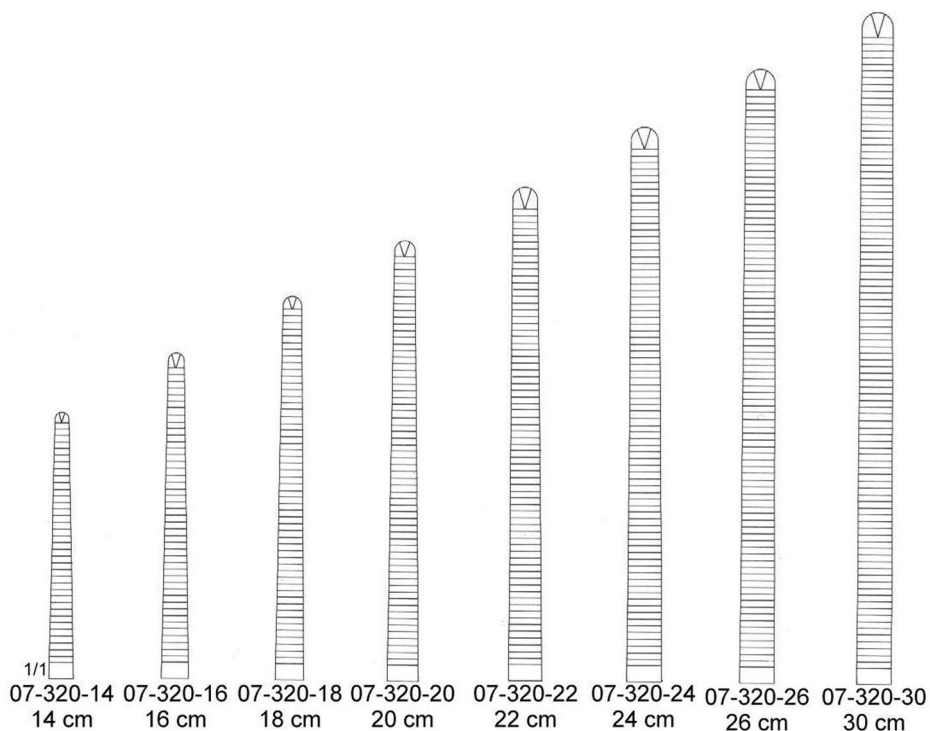

Kocher (Ochsner)
07-320-14 - 07-321-30
1:2 Teeth

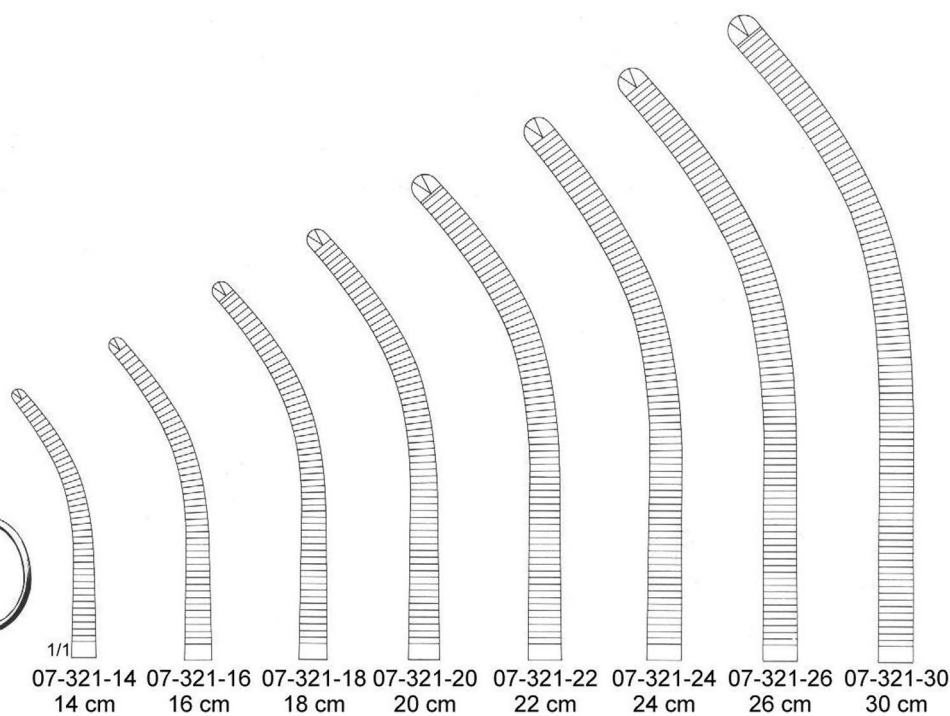

SURGICAL FORCEPS

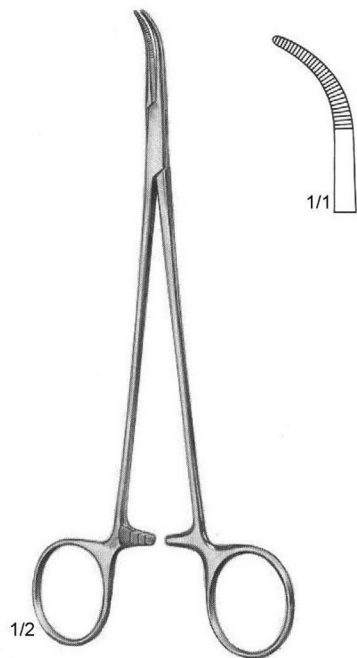

Baby - Mixer
07-331-18
18 cm

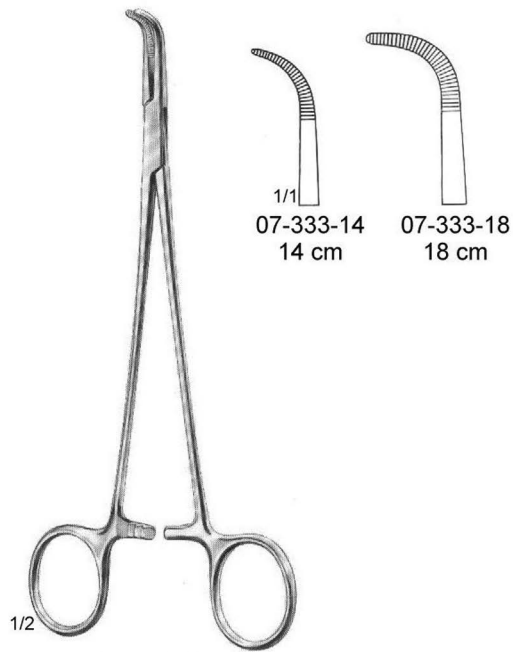

Baby - Adson
07-333-14 - 07-333-18

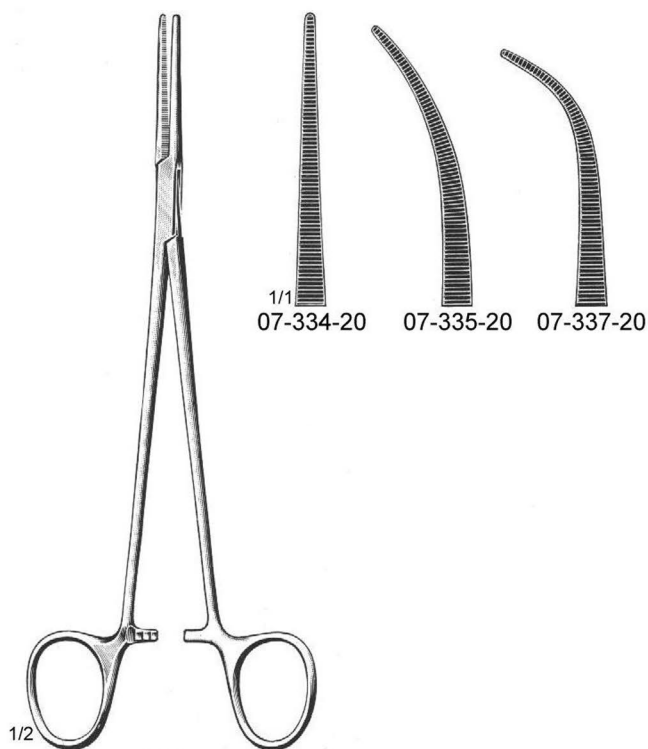

Heiss
07-334-20 - 07-337-20
20 cm

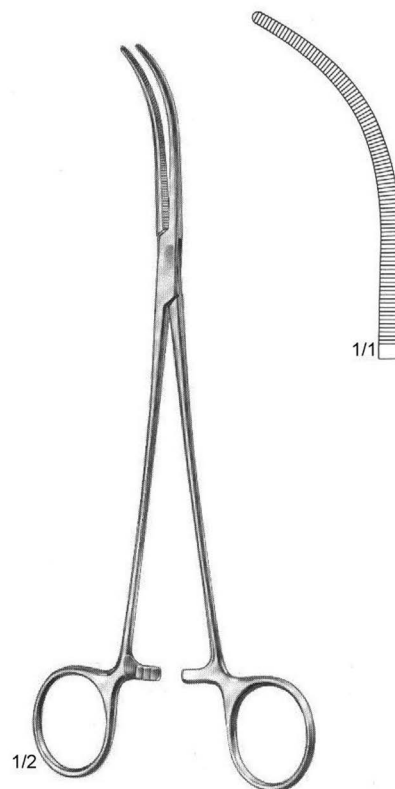

Overhalt - Mixer
07-339-21
21 cm

SURGICAL FORCEPS

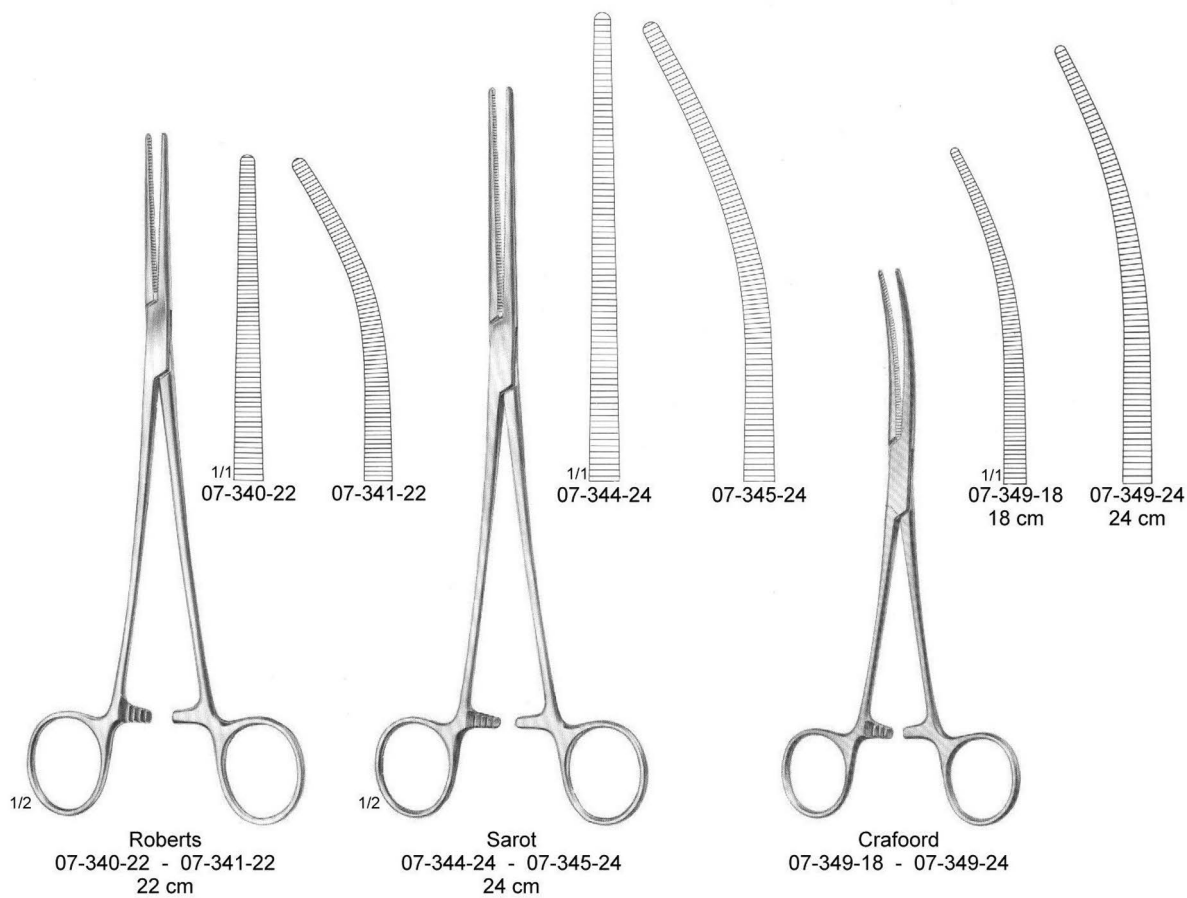

07-95

SURGICAL FORCEPS

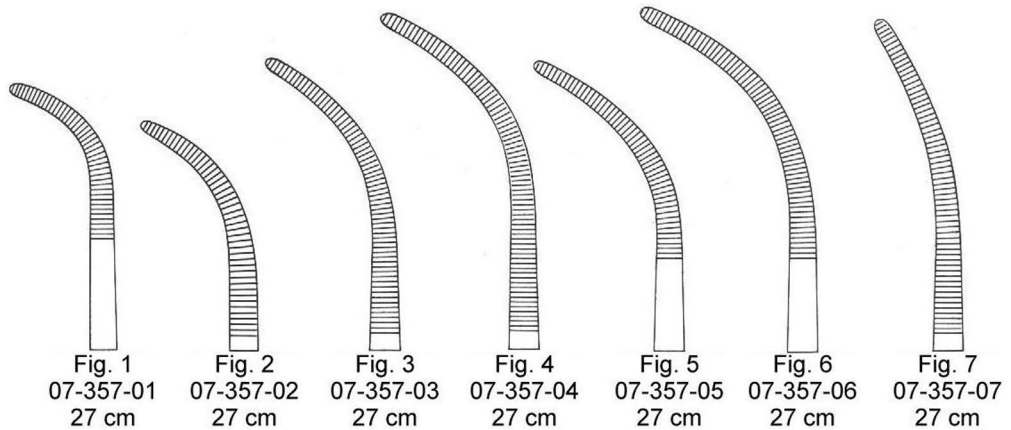
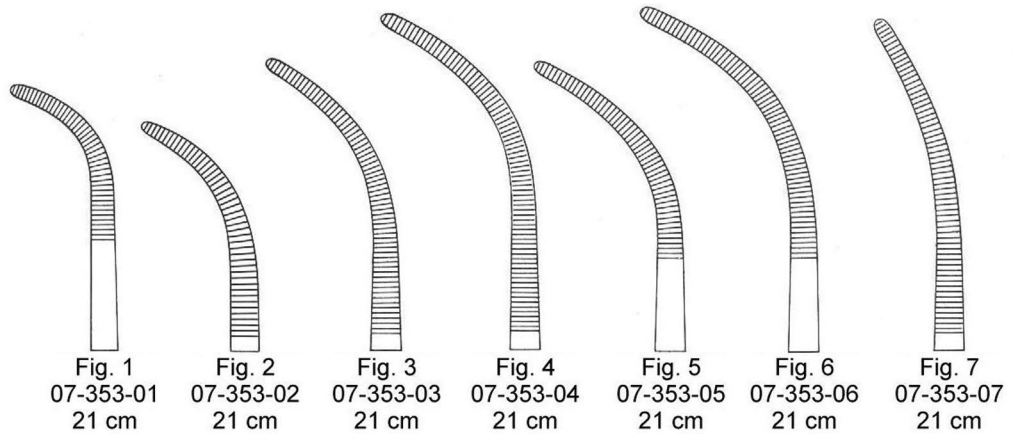

Overholt - Geissendoerfer
07-353-01 - 07-357-07

SURGICAL FORCEPS



Rumel
07-361-01 - 07-261-05
23 cm

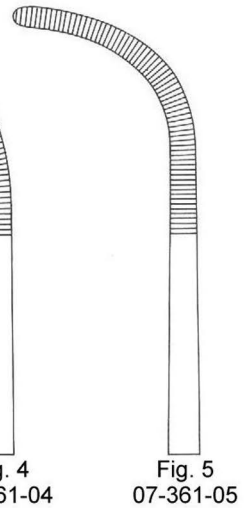
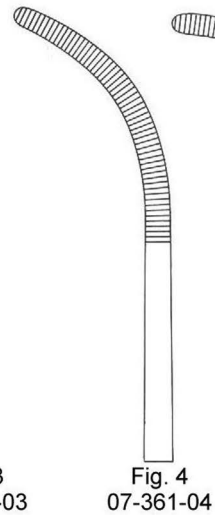
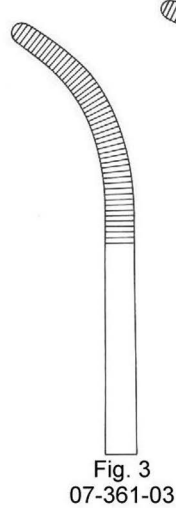
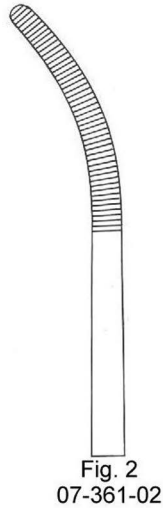
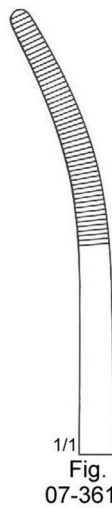

SURGICAL FORCEPS

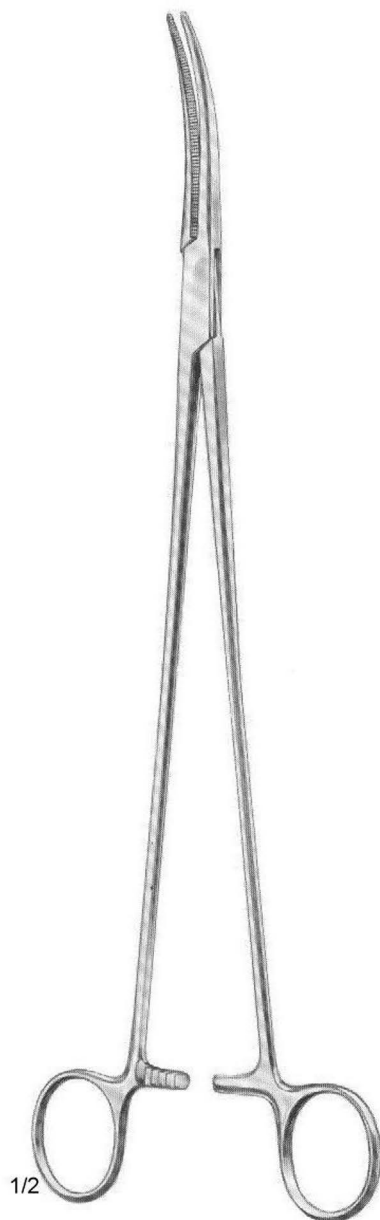

1/2

Zenker
07-365-01 - 07-365-02
29.5 cm

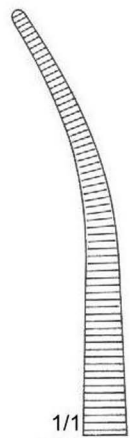

1/1
07-365-01

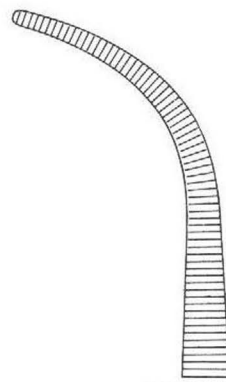

07-365-02

SURGICAL FORCEPS

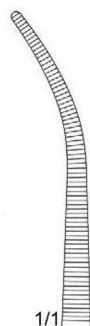

Fig. 1
07-373-19
19 cm

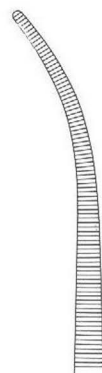

Fig. 1
07-373-22
22 cm



Fig. 1
07-373-24
24 cm

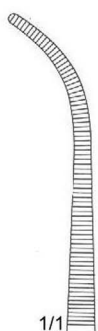

Fig. 2
07-375-19
19 cm

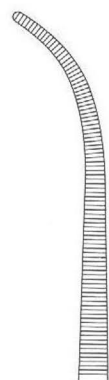

Fig. 2
07-375-22
22 cm



Fig. 2
07-375-24
24 cm



Kelly
07-373-19 - 07-377-24

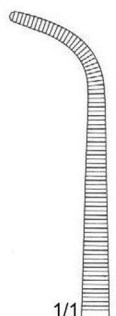

Fig. 3
07-377-19
19 cm

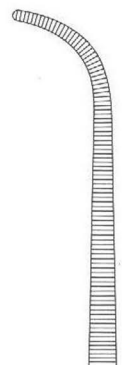

Fig. 3
07-377-22
22 cm

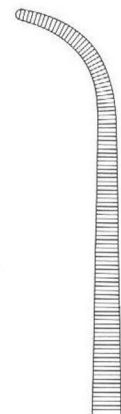
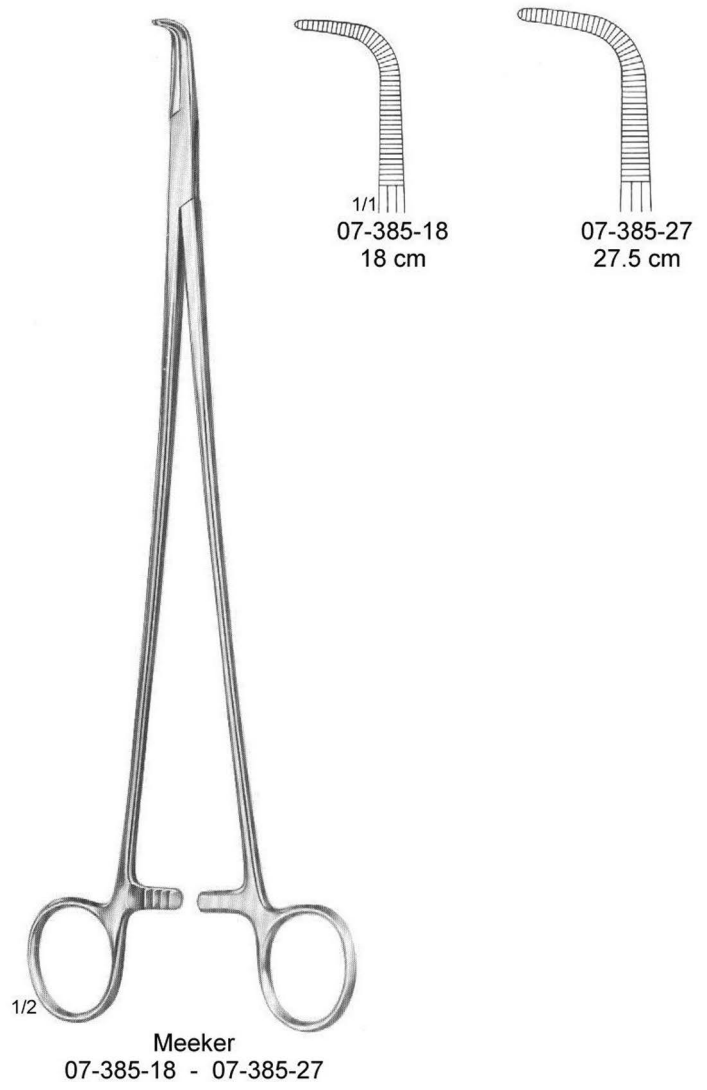
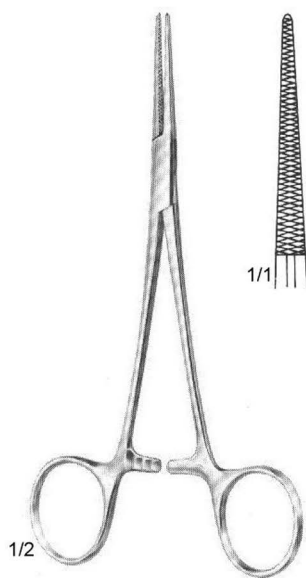

Fig. 3
07-377-24
24 cm

SURGICAL FORCEPS



SURGICAL FORCEPS



Dixon - Lovelace
07-390-15
15.5 cm

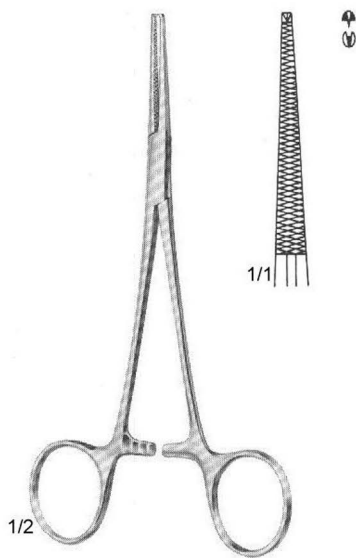

Dixon - Lovelace
07-392-15
15.5 cm
1:2 Teeth

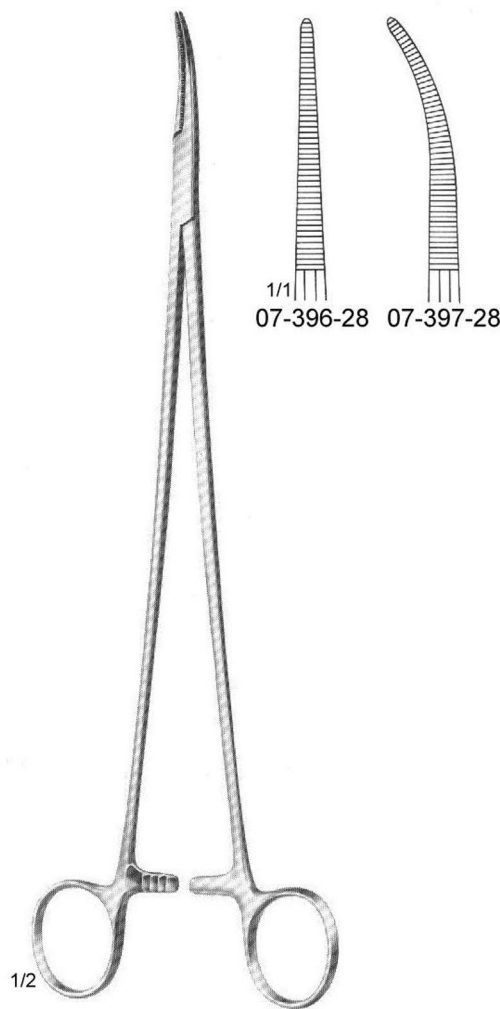

Bridge
07-396-28 - 07-397-28
28 cm

SURGICAL FORCEPS

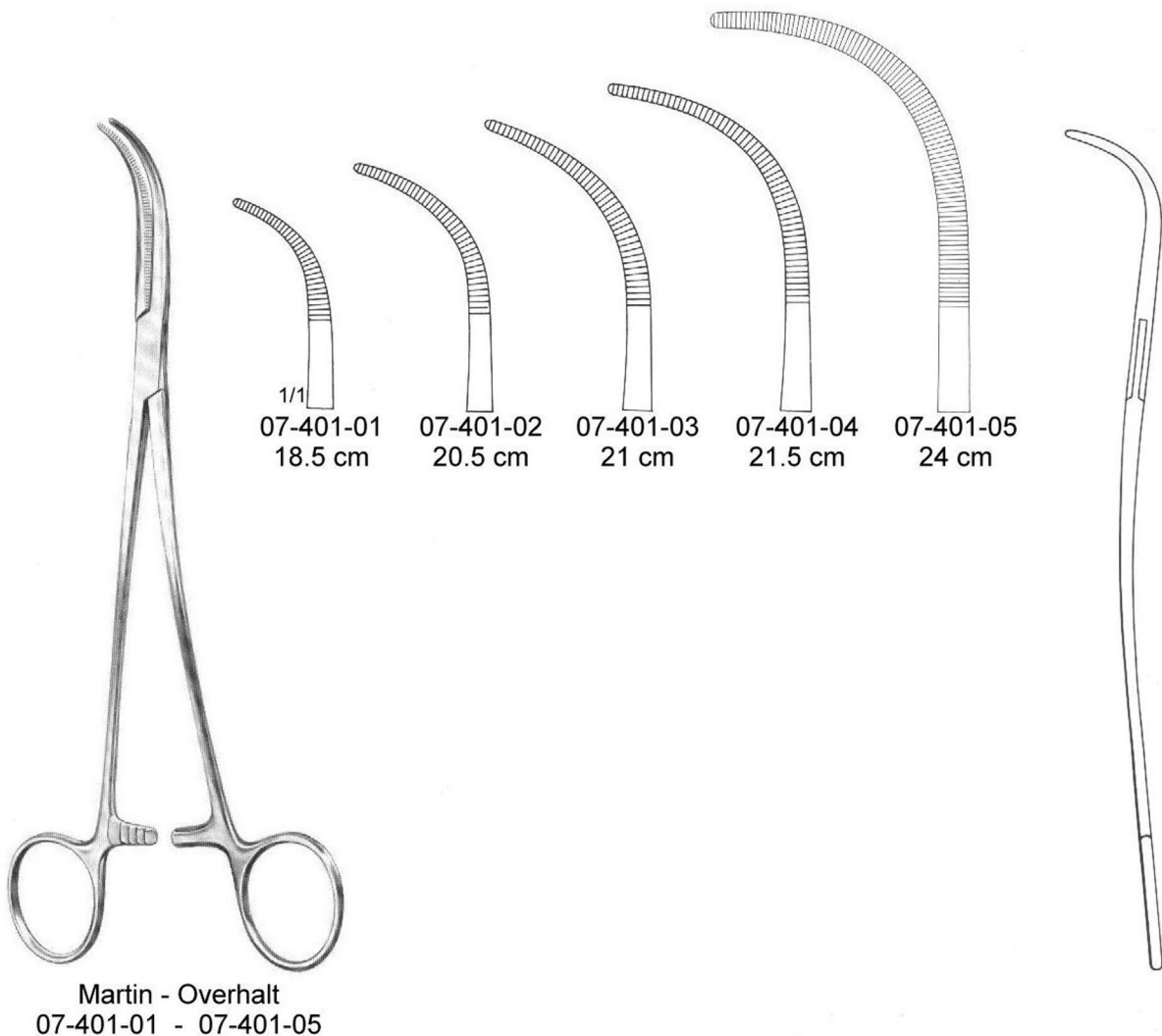

SURGICAL FORCEPS

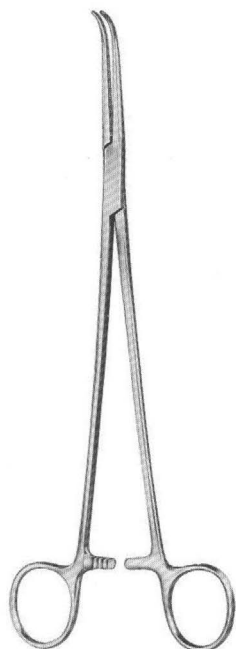

Mini - Gemini
07-403-18 - 07-403-28

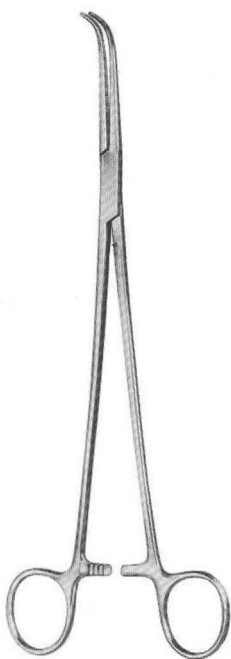
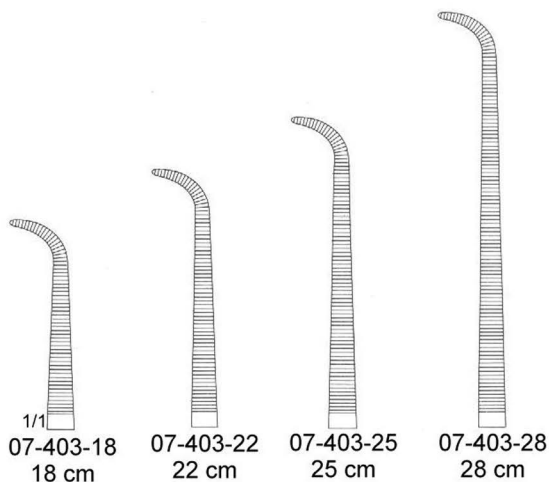

Gemini
07-407-13 - 07-407-28

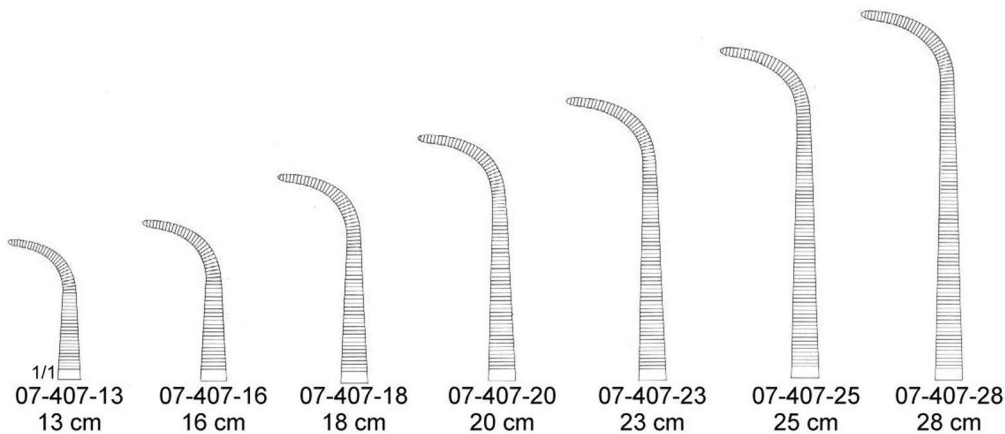

SURGICAL FORCEPS

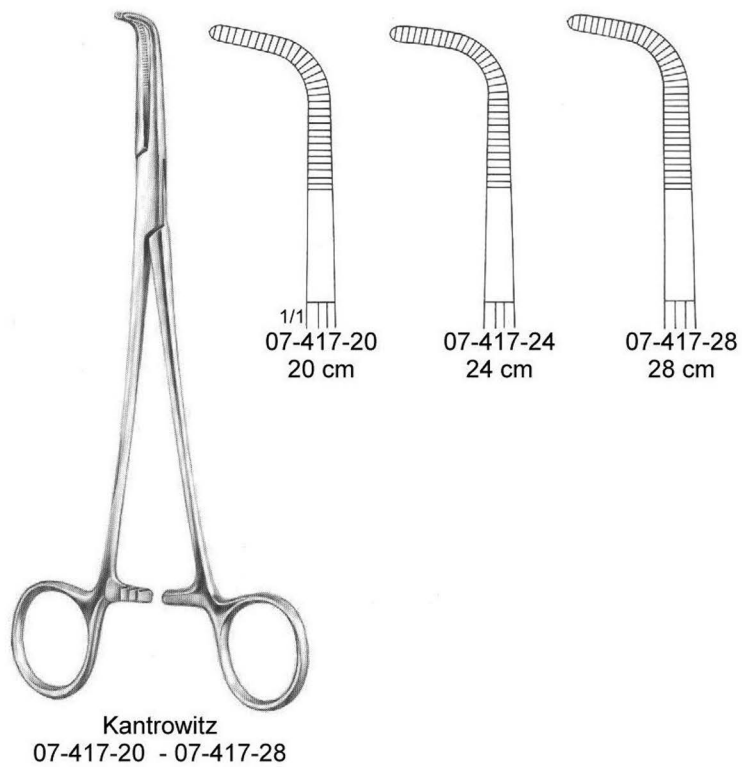
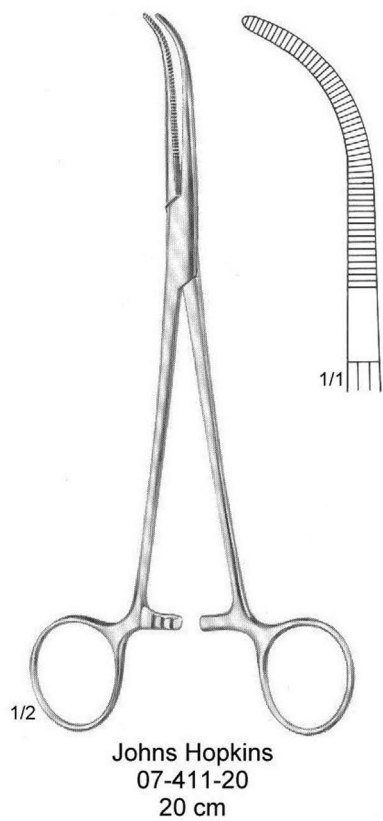

SURGICAL FORCEPS

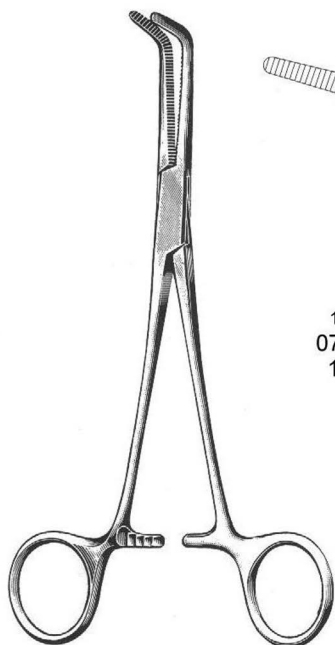

Mixer
07-431-15 - 07-431-19

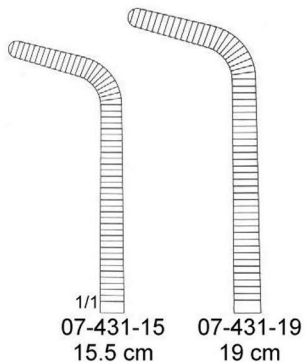

Mixer - O'Shaughnessy
07-433-15 - 07-433-19

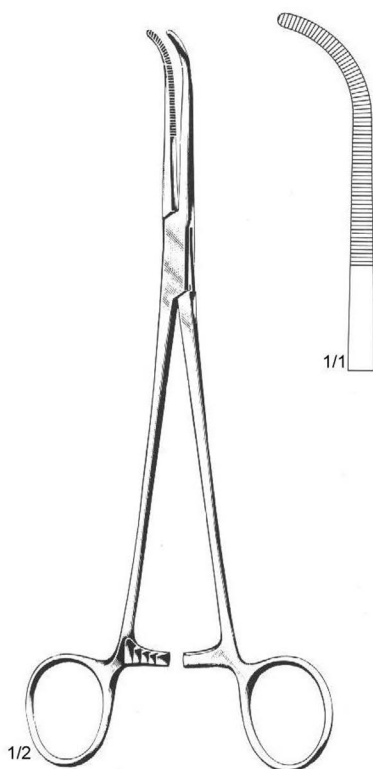
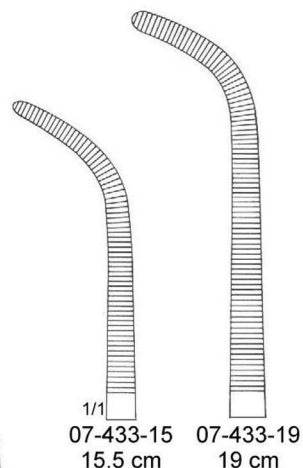

1/2
Mixer
07-437-22
22 cm

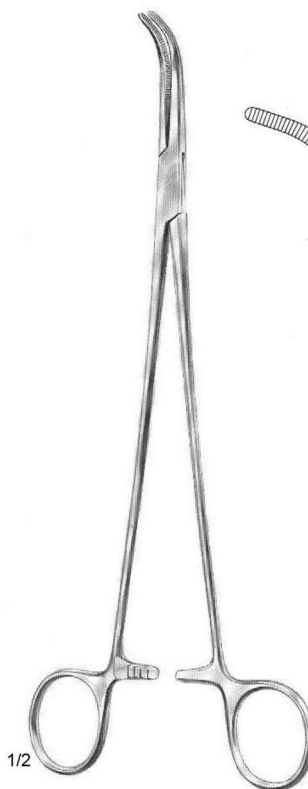
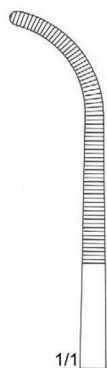

1/2
Mixer
07-439-23
23 cm

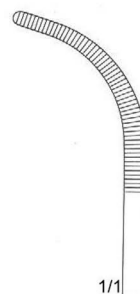

SURGICAL FORCEPS

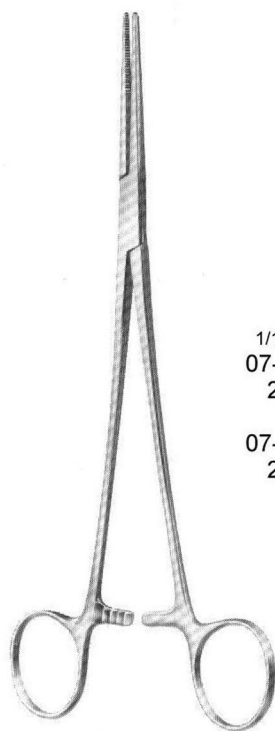

Toennis
07-420-21 - 07-421-26

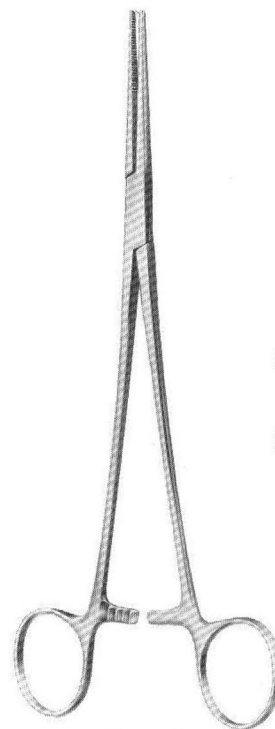
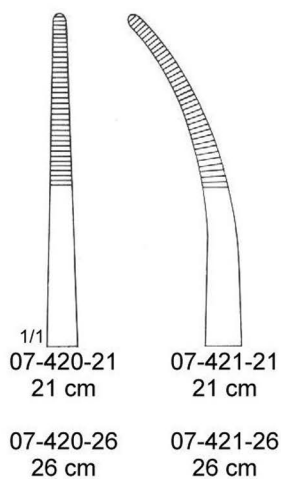

Toennis
07-422-21 - 07-423-26
1:2 Teeth

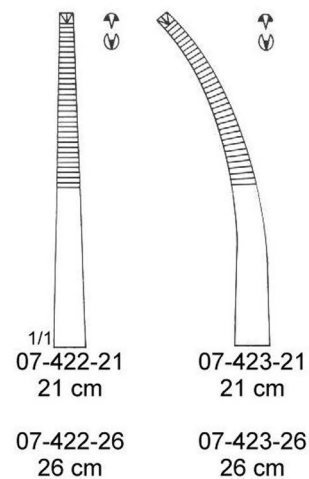

SURGICAL FORCEPS

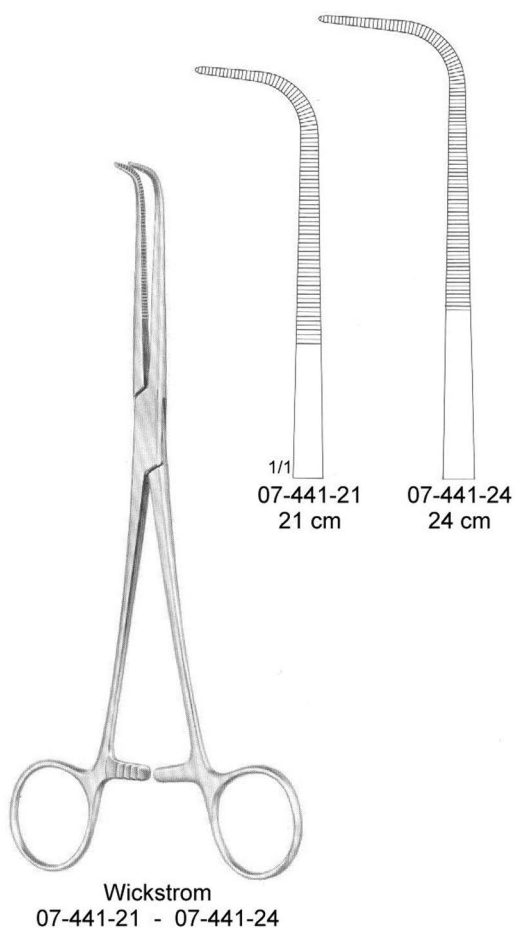

SURGICAL FORCEPS

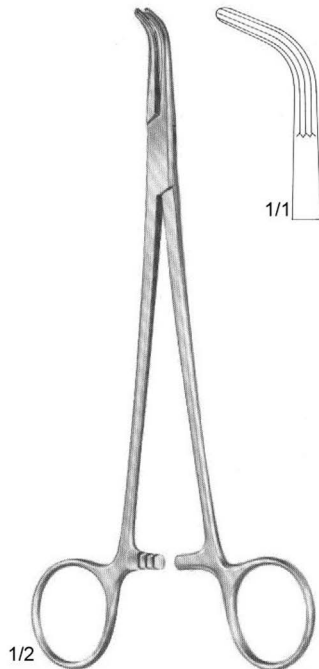

Lower
07-451-18
18 cm



Lahey
07-455-19 - 07-457-23

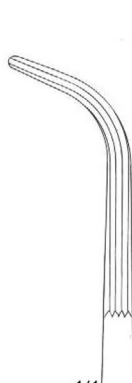

07-455-19
19 cm

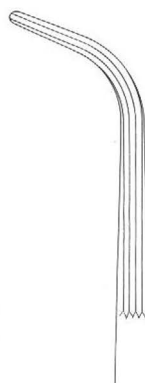

07-457-23
23 cm

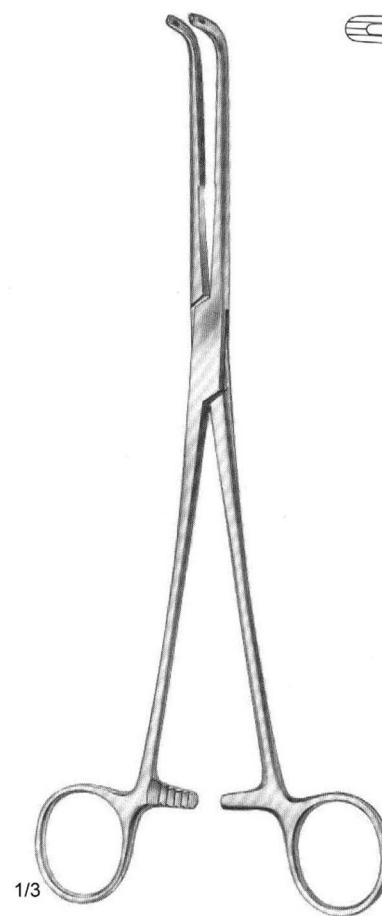

Finochietto
07-459-24
24 cm



SURGICAL FORCEPS

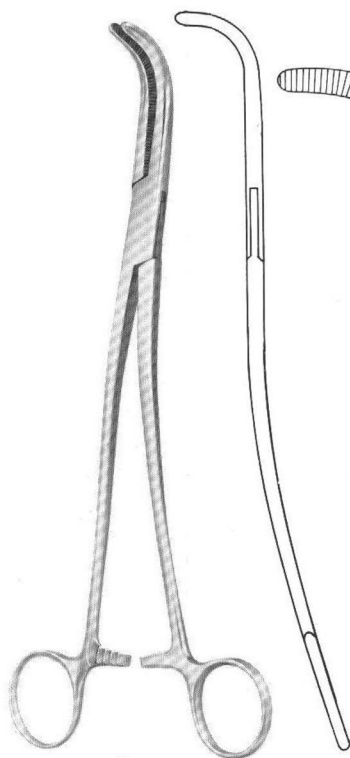

Gray
07-461-22 - 07-461-23

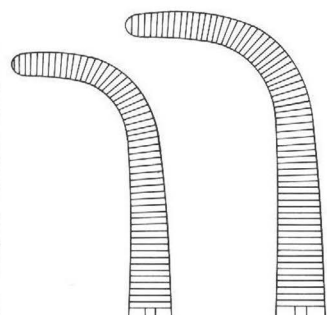

07-461-22
22 cm 07-461-23
23 cm

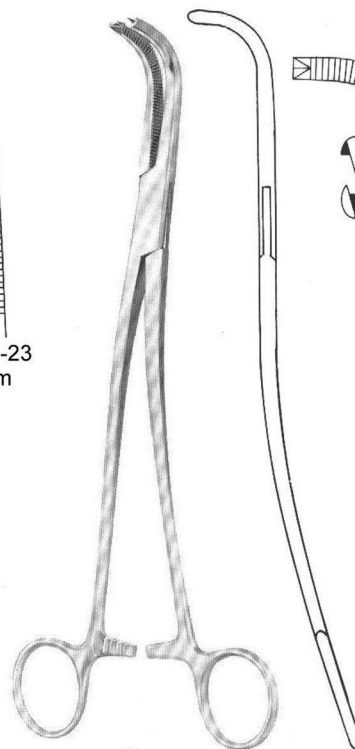

Gray
07-465-22 - 07-465-23
1:2 Teeth

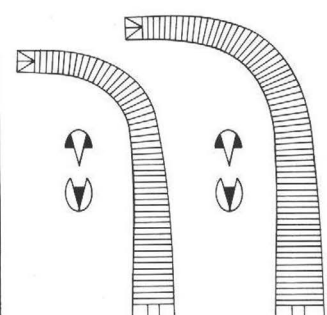

07-465-22
22 cm 07-465-23
23 cm

SURGICAL FORCEPS

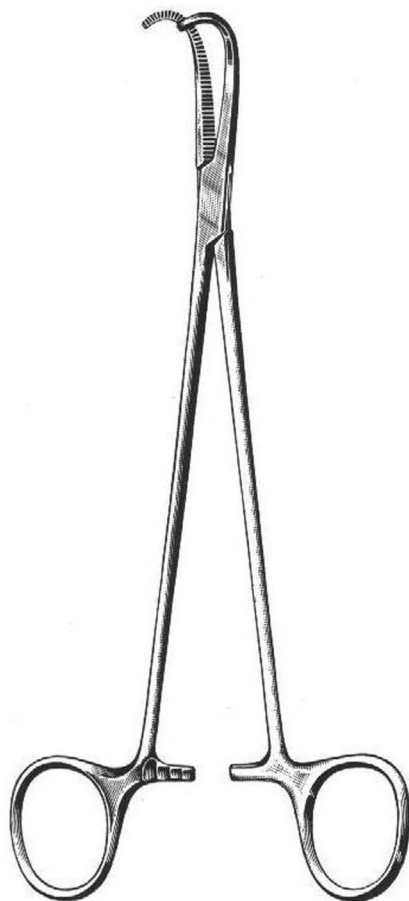

Negus
07-475-19 - 07-477-19
19 cm

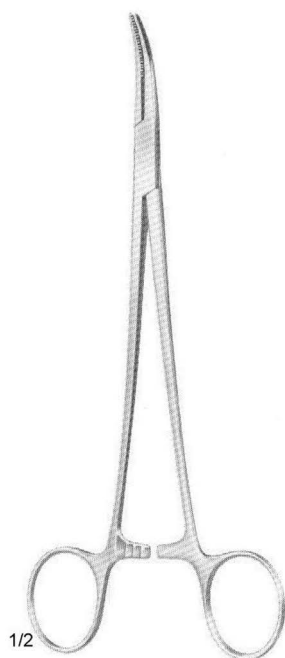

Fig. 1
07-475-19

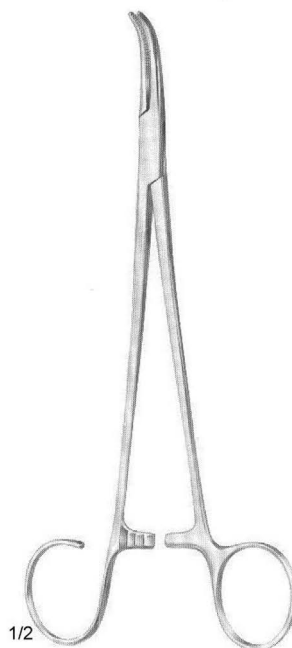
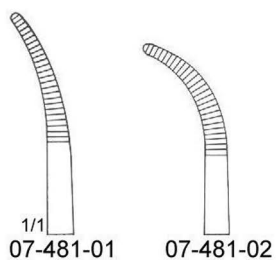

Fig. 2
07-477-19

SURGICAL FORCEPS



Schmidt - Sawtell
07-481-01 - 07-481-02
19 cm



Schmidt - Sawtell
07-485-01 - 07-485-02
19 cm

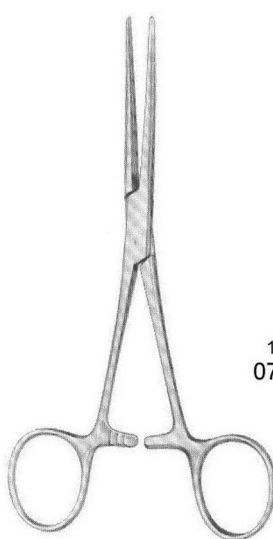
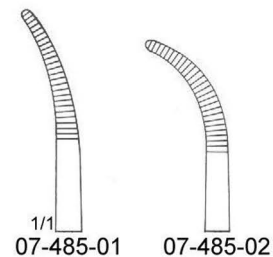

Bainbridge
07-496-15 15.0 cm 07-497-15
07-496-18 18.5 cm 07-497-18

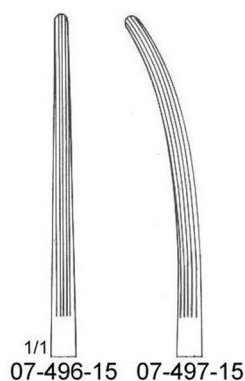

SURGICAL FORCEPS

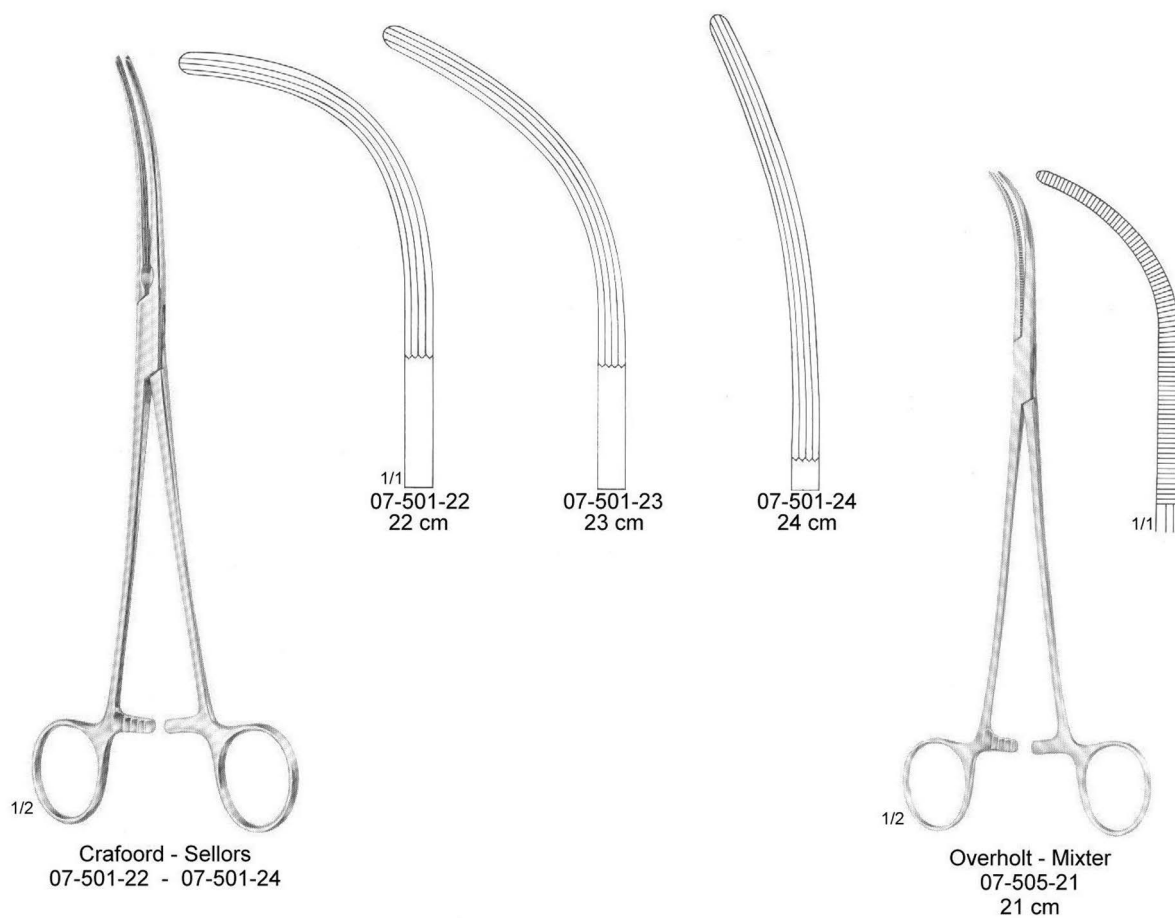

SURGICAL FORCEPS

Atrauma

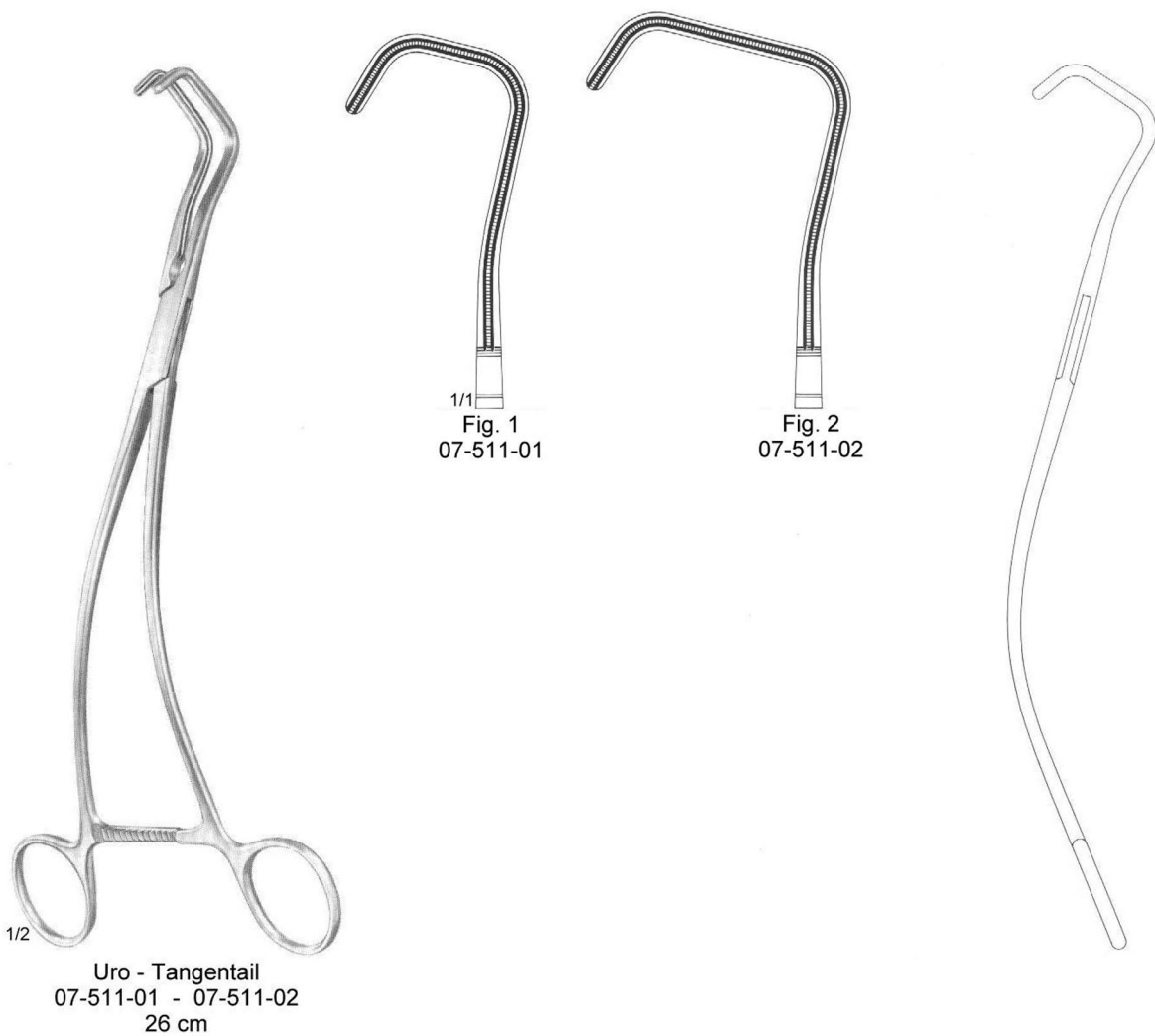

SURGICAL FORCEPS

Atrauma



Guyon
07-517-23 - 07-517-24

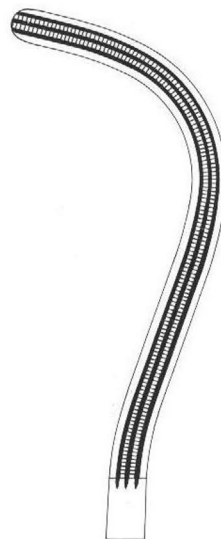

07-517-23
23 cm

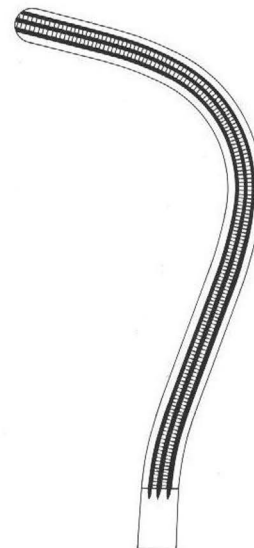

07-517-24
24 cm

SURGICAL FORCEPS

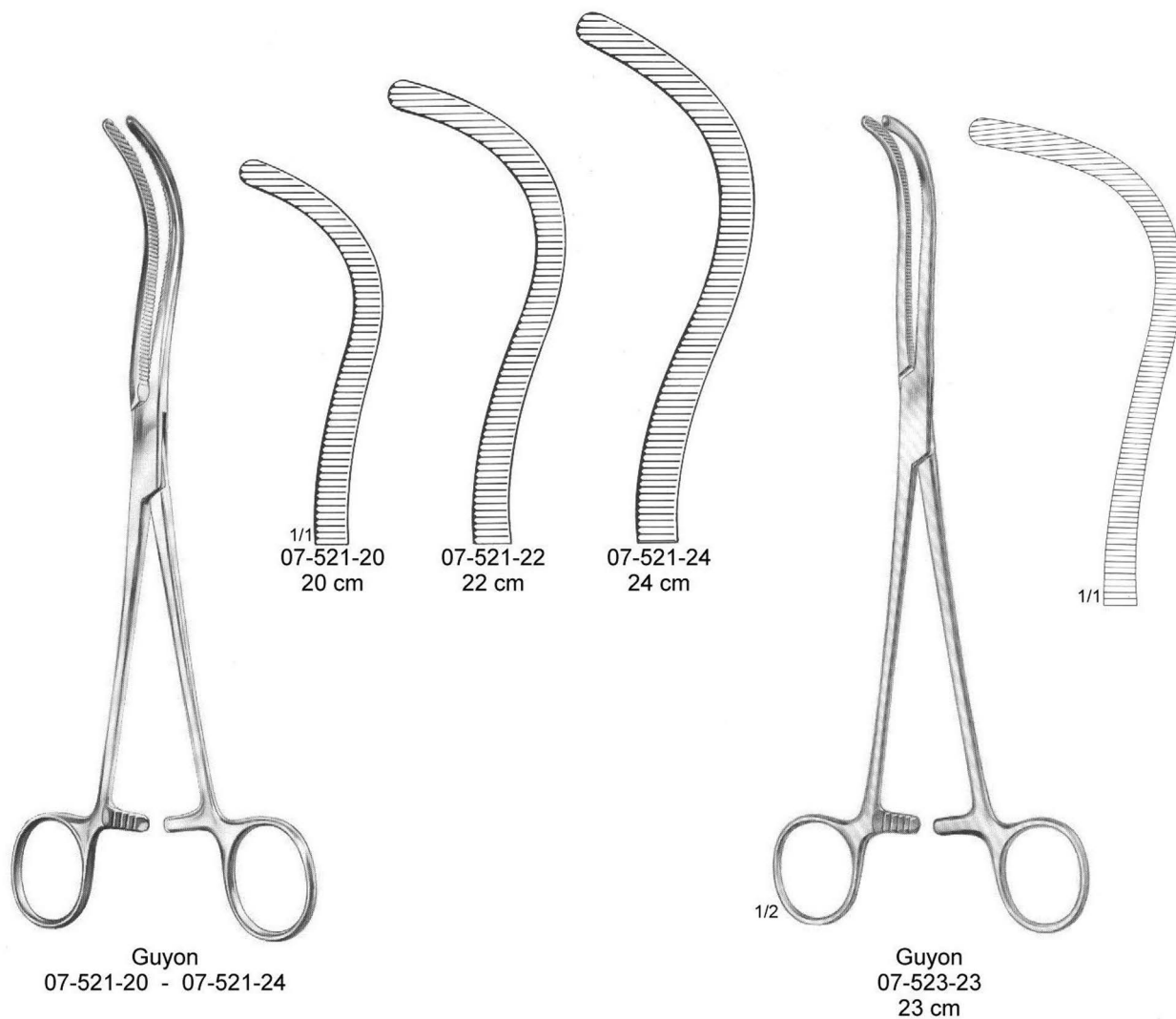

SURGICAL FORCEPS

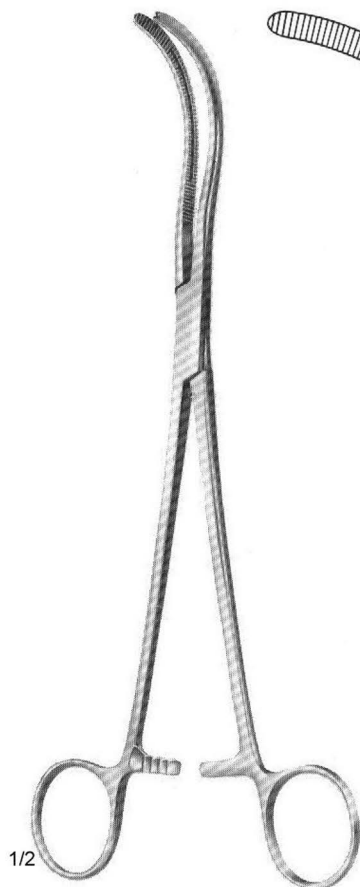

Stille
07-527-23
23 cm



Herrick
07-529-23
23 cm



SURGICAL FORCEPS

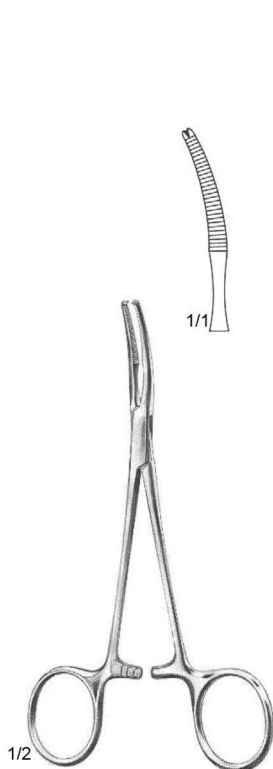

Baby - Mikulicz
07-541-14
14 cm
1:2 Teeth

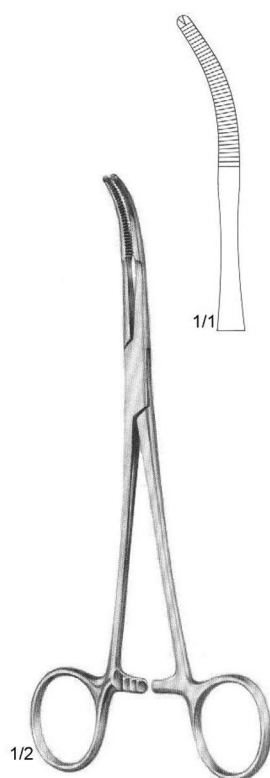

Mikulicz
07-545-18
18 cm
1:2 Teeth

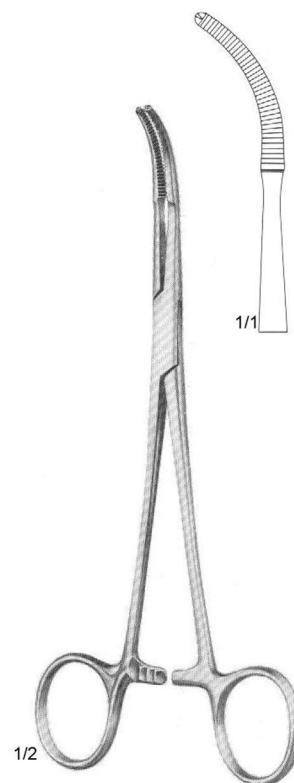

Mikulicz
07-547-20
20 cm
1:2 Teeth

SURGICAL FORCEPS

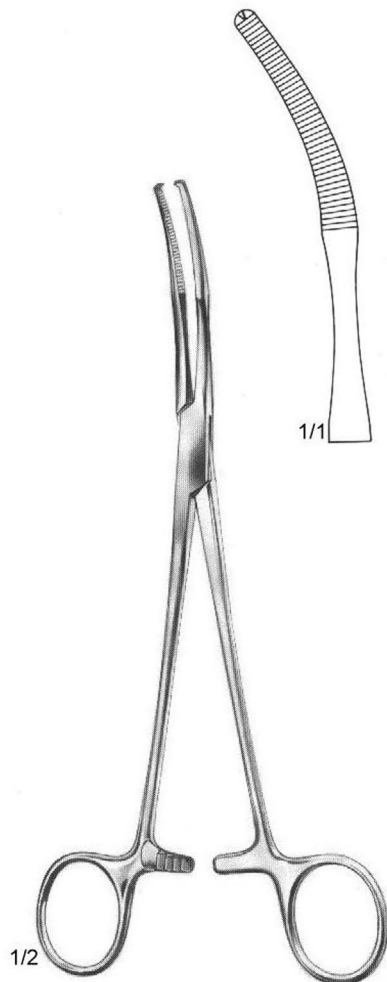

Mikulicz
07-551-20
20 cm
1:2 Teeth

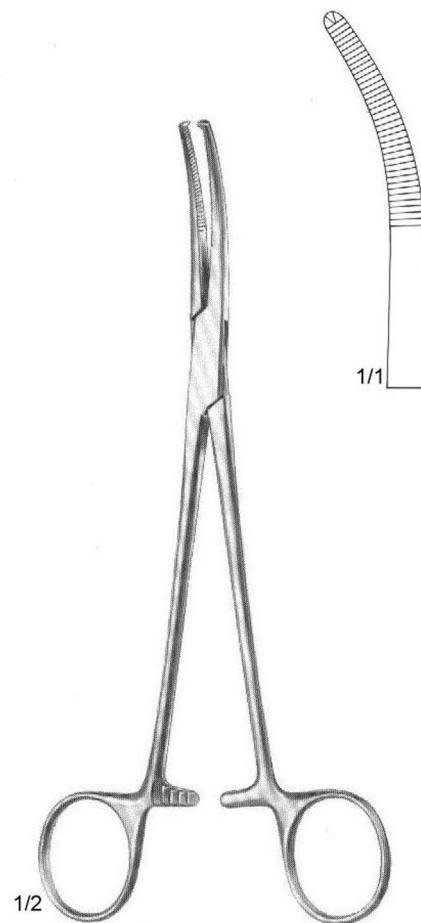

Mikulicz
07-555-20
20.5 cm
1:2 Teeth

SURGICAL FORCEPS

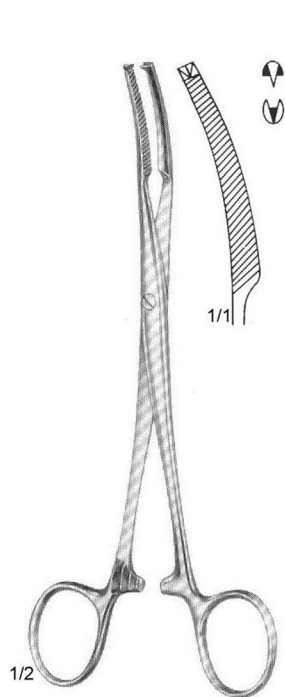

Mikulicz
07-561-18
18 cm
1:2 Teeth

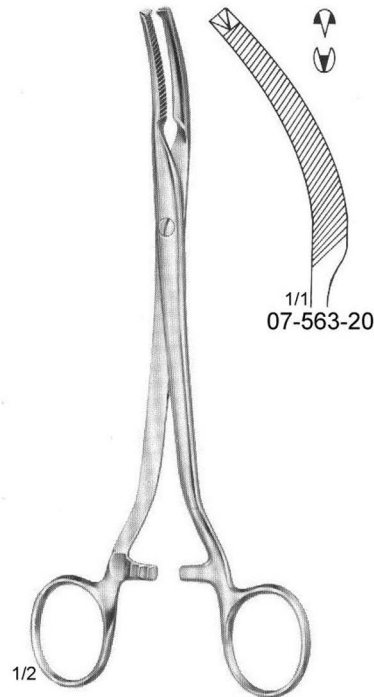

Mikulicz
07-563-20 - 07-565-20
20 cm
1:2 Teeth

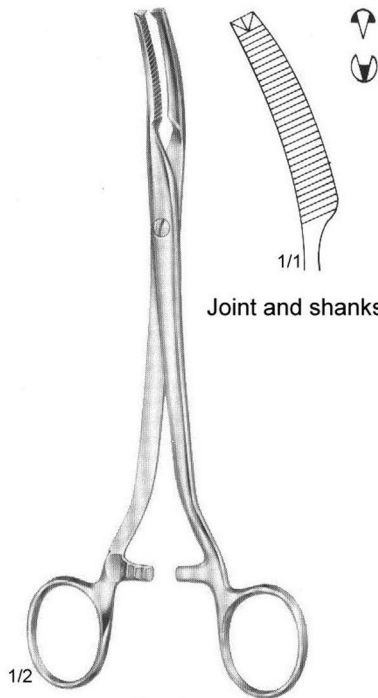

Mikulicz
07-567-20
20.5 cm
1:2 Teeth

Joint and shanks extra strong

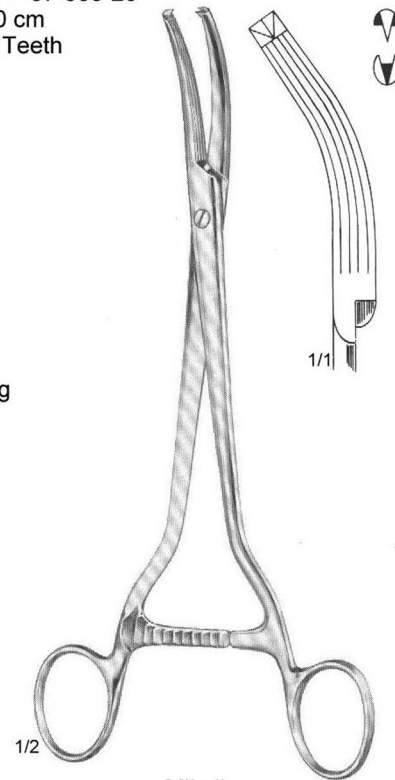

Mikulicz
07-569-23
23 cm
1:2 Teeth

SURGICAL FORCEPS

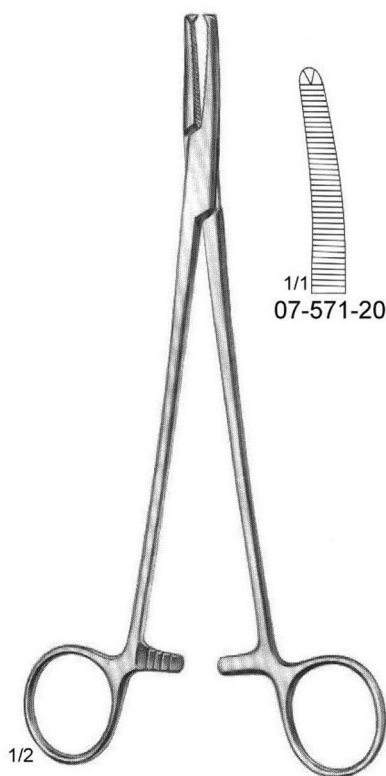

Faure
07-571-20 - 07-573-20
20 cm
1:2 Teeth

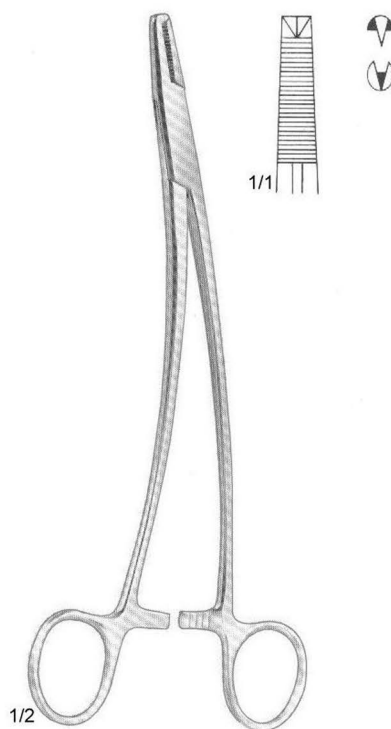
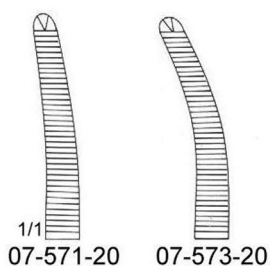

Schindler
07-577-20
20 cm
1:2 Teeth

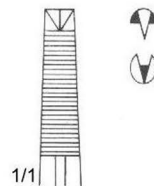

SURGICAL FORCEPS

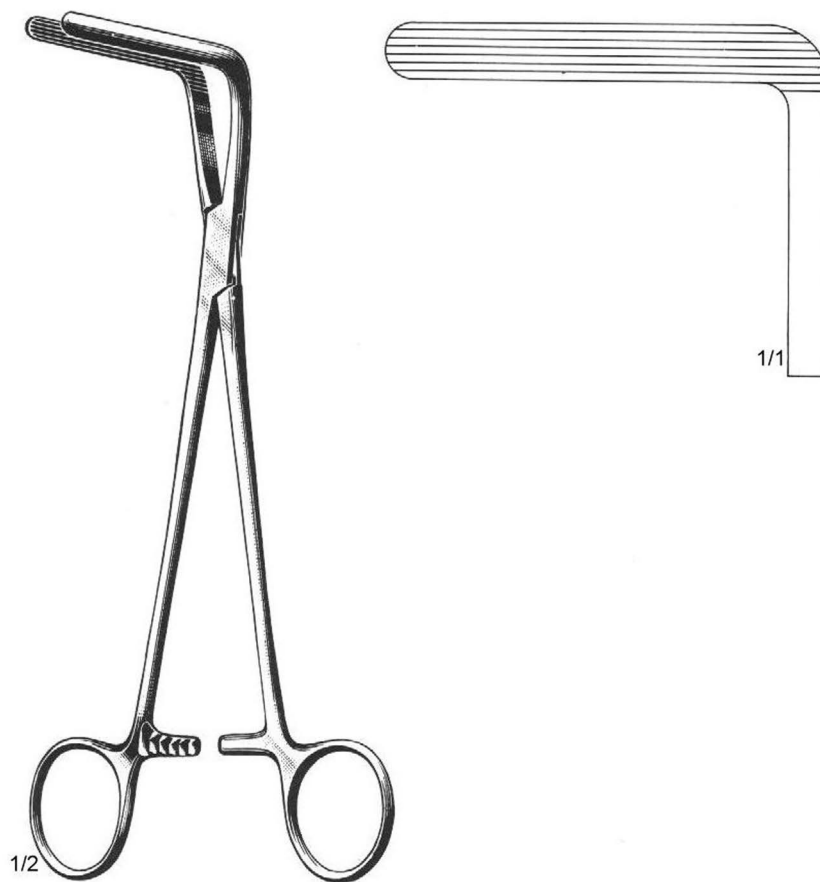

Wertheim - Cullen
07-585-21
21.5 cm

SURGICAL FORCEPS

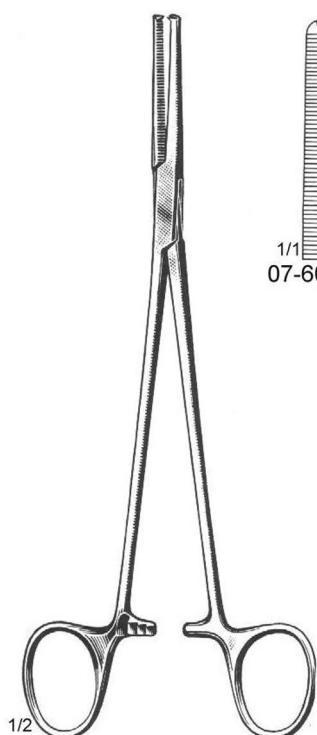

Phaneuf
07-600-21 - 07-601-21
21.5 cm
1:2 Teeth

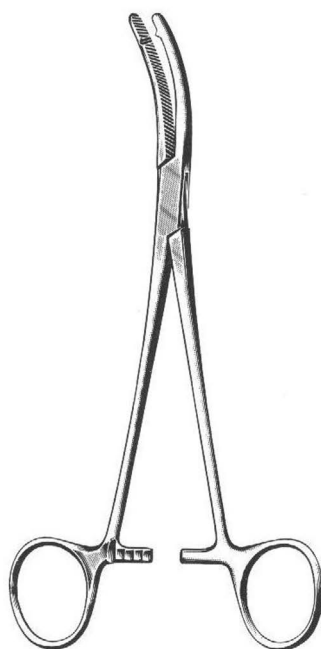
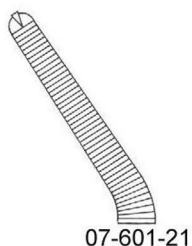
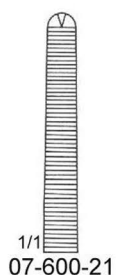

Heaney
07-607-19 - 07-609-23

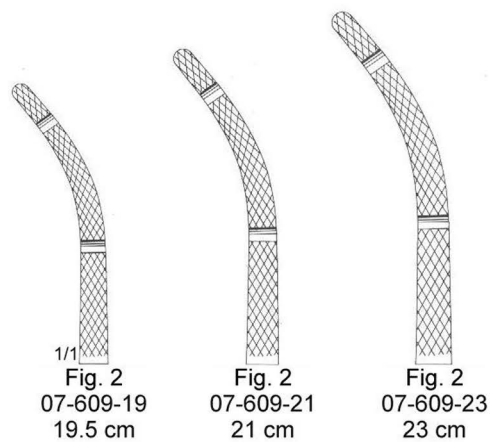
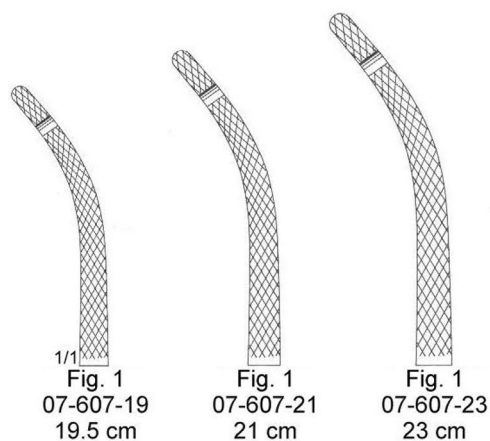

SURGICAL FORCEPS

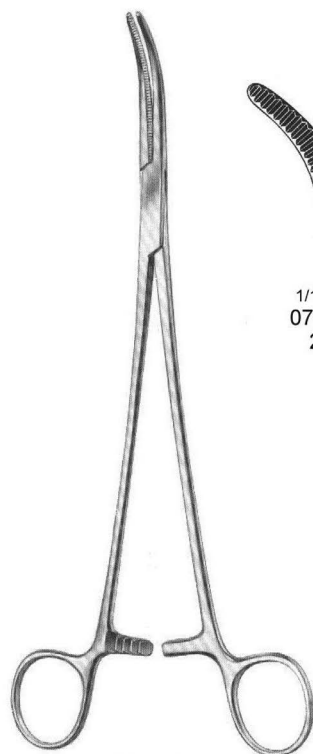

Moynihan
07-613-23 - 07-615-24

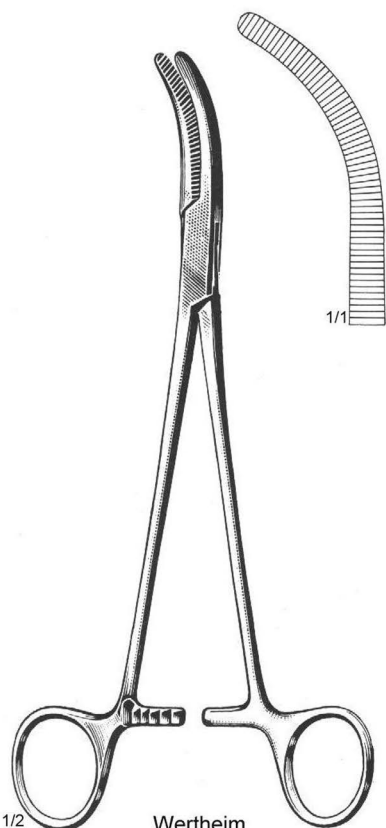
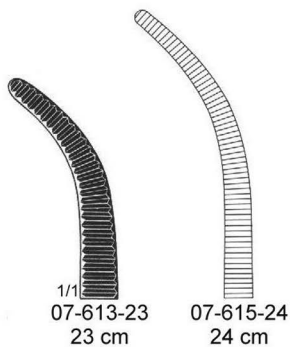

1/2
Wertheim
07-621-25
25 cm

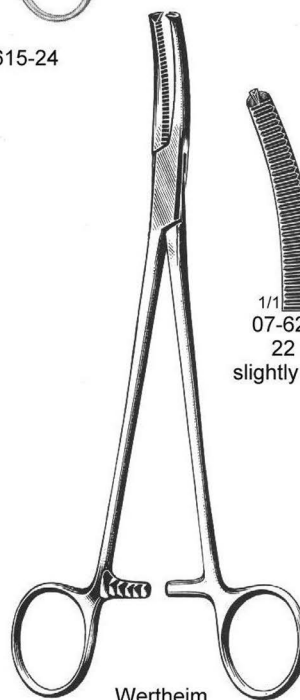

Wertheim
07-625-22 - 07-627-23
1:2 Teeth

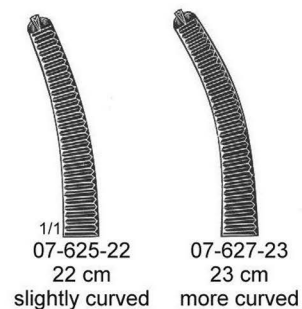

SURGICAL FORCEPS



Rogers
07-635-10 - 07-637-40

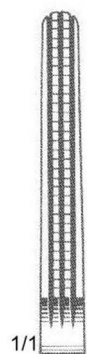

1/1
Fig. 1
07-635-10
22 cm

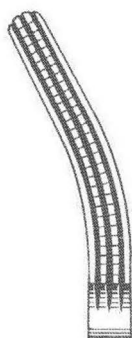

Fig. 2
07-635-20
21.5 cm

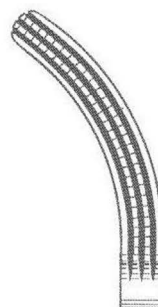

Fig. 3
07-635-30
21 cm

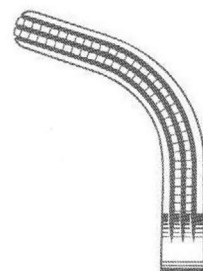
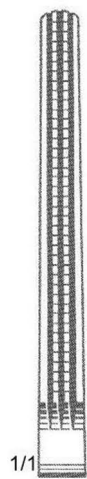

Fig. 4
07-635-40
20.5 cm



1/1
Fig. 1
07-637-10
25 cm

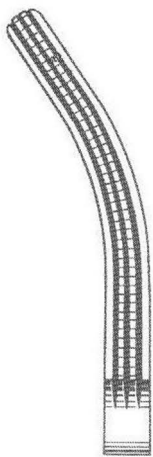

Fig. 2
07-637-20
25 cm

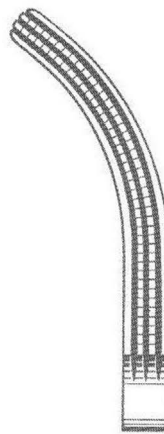

Fig. 3
07-637-30
24.5 cm

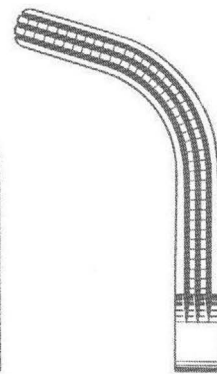
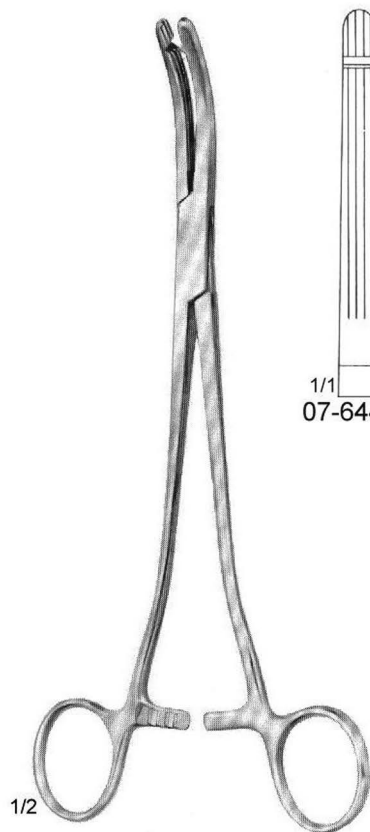
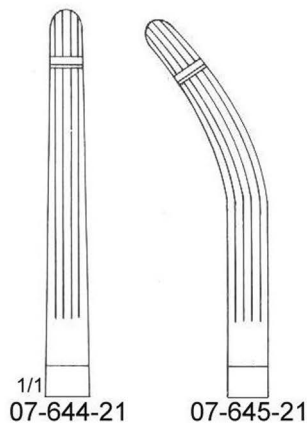

Fig. 4
07-637-40
23 cm

SURGICAL FORCEPS



Heaney - Ballantine
07-644-21 - 07-645-21
21 cm



1/1
07-644-21

07-645-21

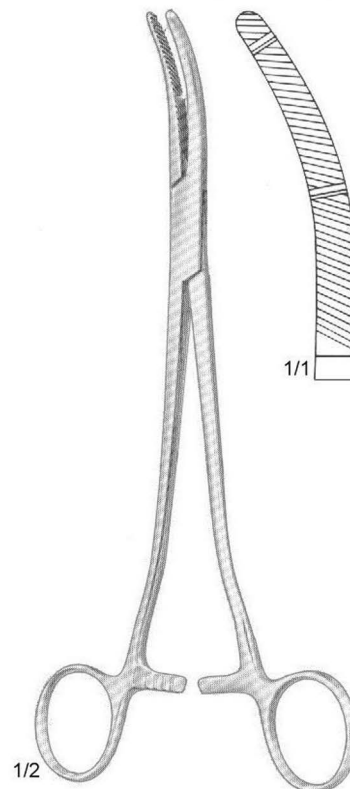

Heaney - Kanter
07-647-21
21 cm

1/1

SURGICAL FORCEPS

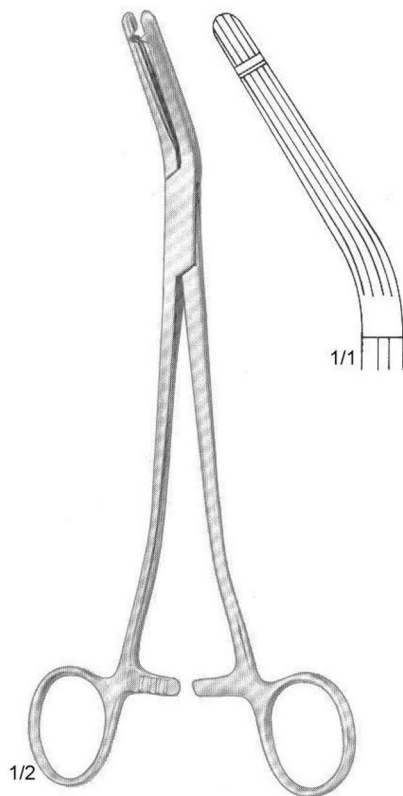

Garland
07-653-21
21 cm

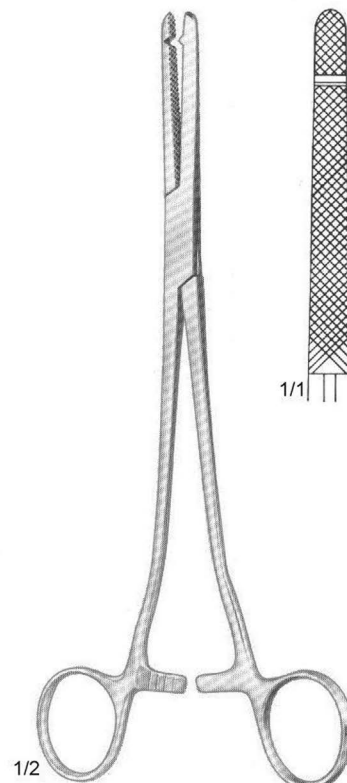

Heaney - Rezak
07-657-21
21 cm

SURGICAL FORCEPS

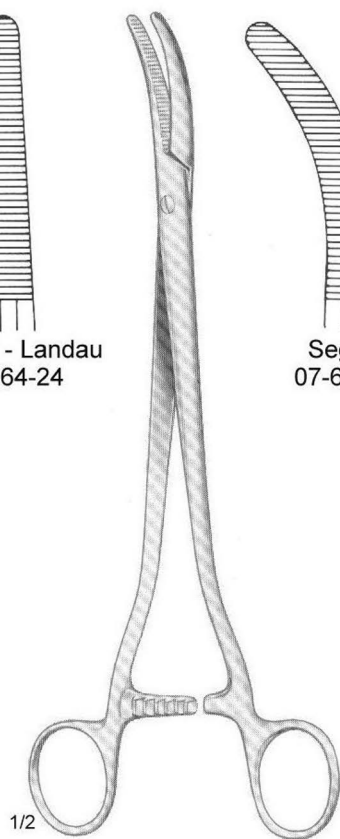
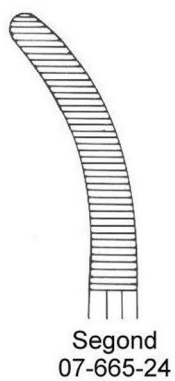
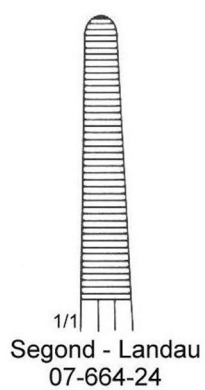

07-664-24 - 07-665-24
24 cm

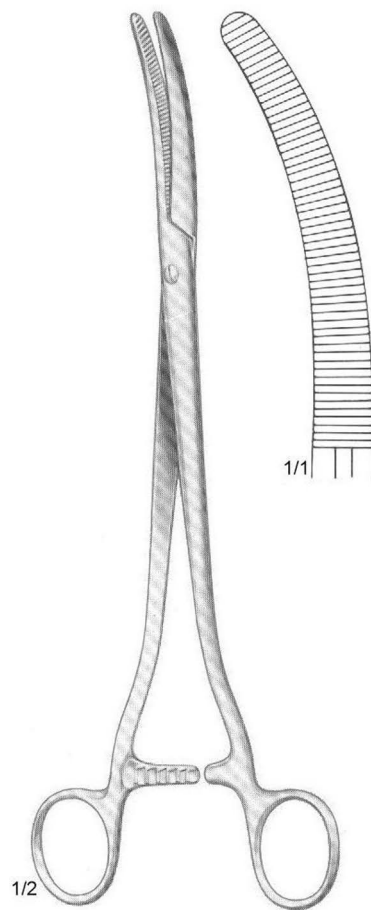

Faure
07-667-25
25 cm

SURGICAL FORCEPS

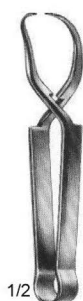

Schaedel
07-671-09 9 cm



Jones
07-673-05 5 cm
07-673-09 9 cm



Jones-Martin
07-675-09 9 cm
with clip



Backhaus
07-681-11 11 cm
07-681-13 13 cm

delicate pattern

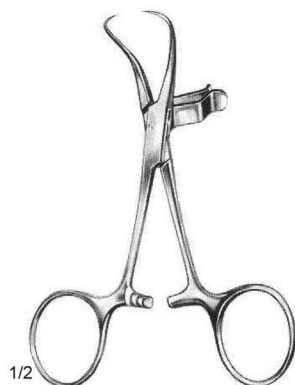

Backhaus
07-683-11 11 cm

with clip

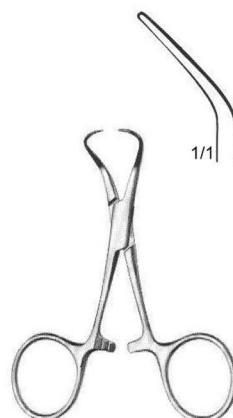

Backhaus
07-685-08 8 cm
07-685-11 11 cm
07-685-13 13 cm
07-685-15 15 cm

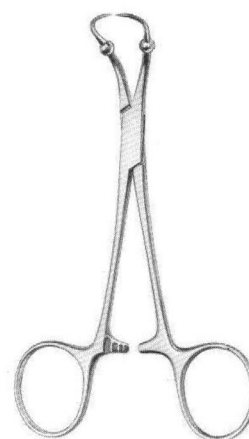

Roeder
07-687-13 13 cm
07-687-15 15 cm

SURGICAL FORCEPS

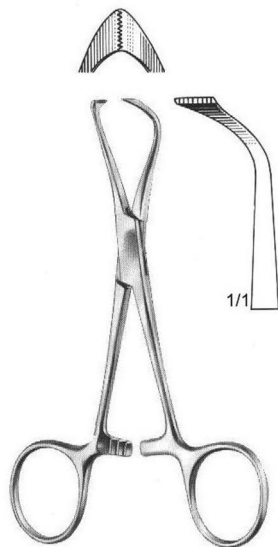

Lorna
07-691-10 10 cm
07-691-13 13 cm

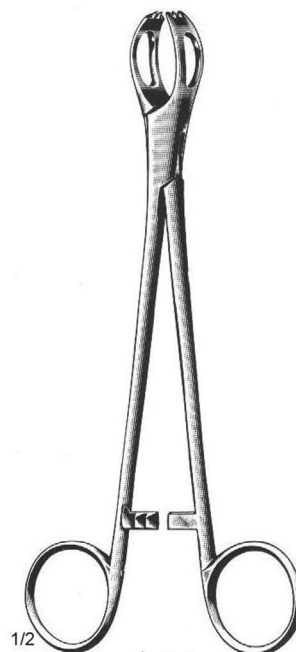

Lane
07-695-20
20 cm

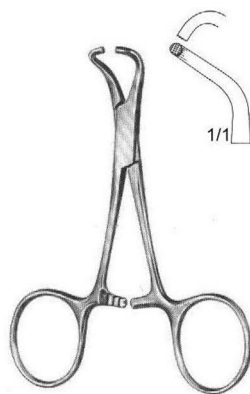

Tohoku
07-697-10 10 cm
07-697-13 13 cm

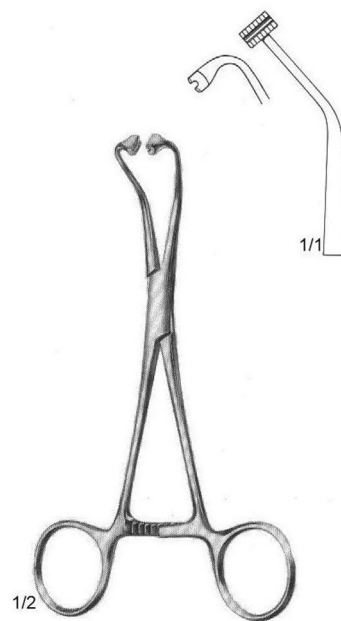

Peers - Bertram
07-699-14
14.5 cm

SURGICAL FORCEPS

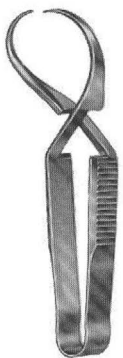

Engl. Modell
07-703-09
9 cm



Doyen
07-705-11
11 cm

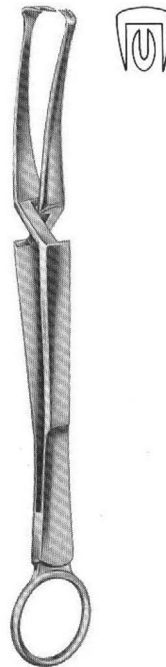

Doyen
07-707-18
18 cm

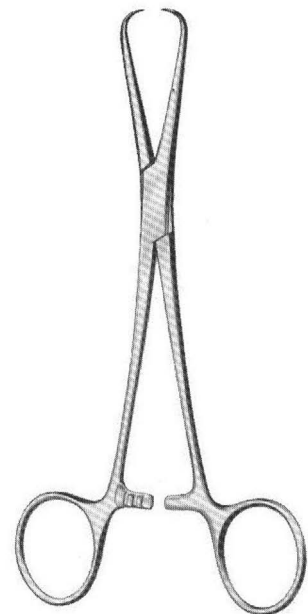

Bernhard
07-713-16
16.5 cm

SURGICAL FORCEPS

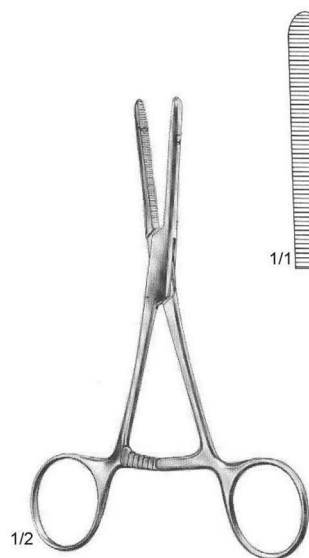

Klinikum Berlin
07-720-14
14.5 cm

With extra long ratchet

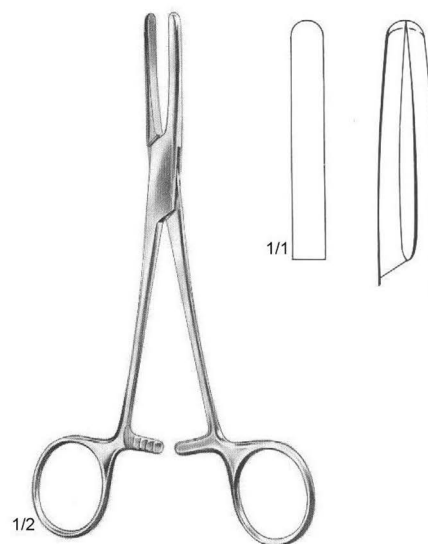

Presbyterian
07-724-16
16.5 cm

SURGICAL FORCEPS



Standard
07-730-15 - 07-730-20

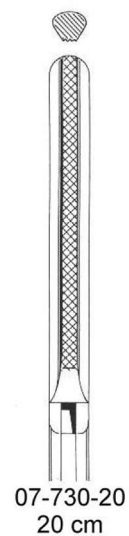
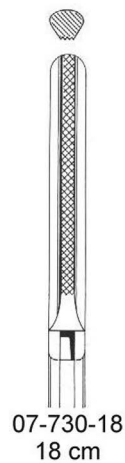
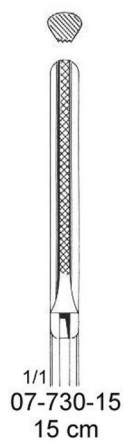

07-734-15 - 07-734-20
with safety guard

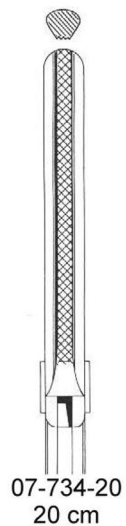
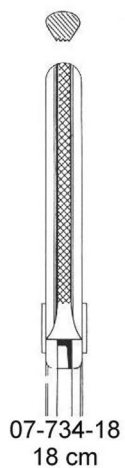
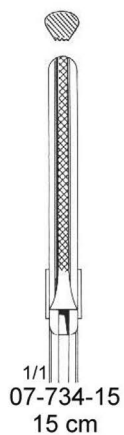
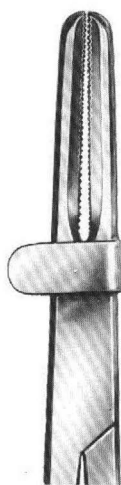



CONTACT US

 +62 856-6381-381

 inquiry@averonindonesia.com

 sales@averonindonesia.com

 www.averonindonesia.com

 Axa tower - Kuningan City Lt 45-7A Jl Prof. DR. Satrio, Kuningan, Kecamatan Setiabudi, Kota Jakarta Selatan, Daerah Khusus Ibukota Jakarta 12940.