



PT.AVERON

— GLOBAL INDONESIA —

IMPORTER & SUPPLIER OF MEDICAL INSTRUMENTS



Surgical Dressing

 www.averonindonesia.com

SURGICAL DRESSING



SURGICAL DRESSING

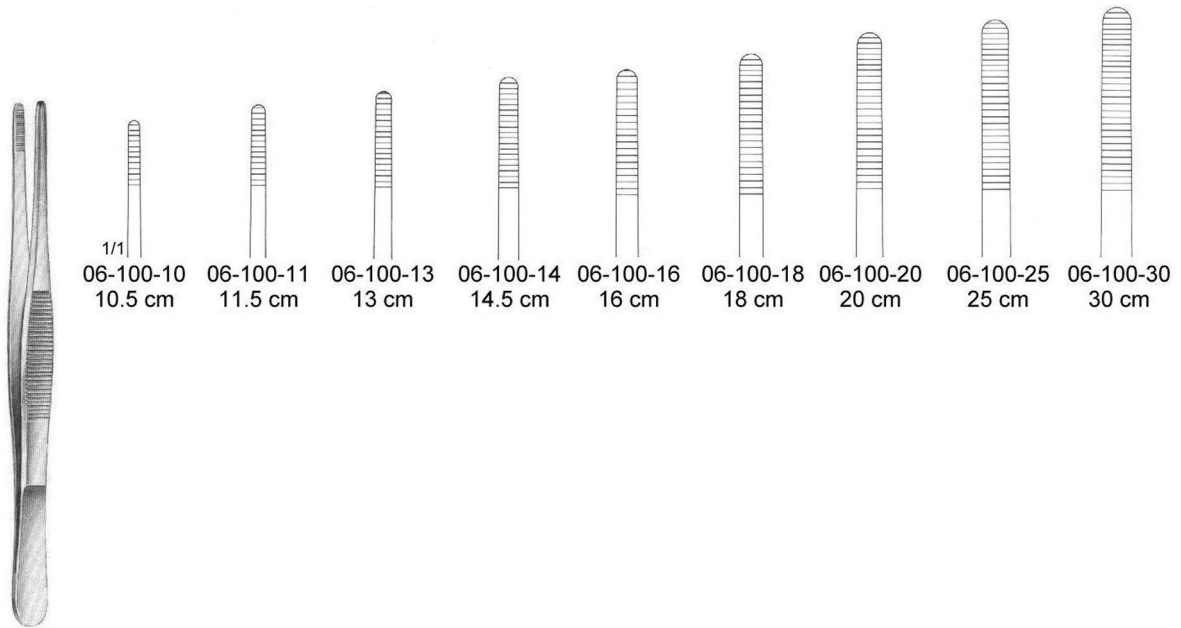

Standard
06-100-10 - 06-100-30

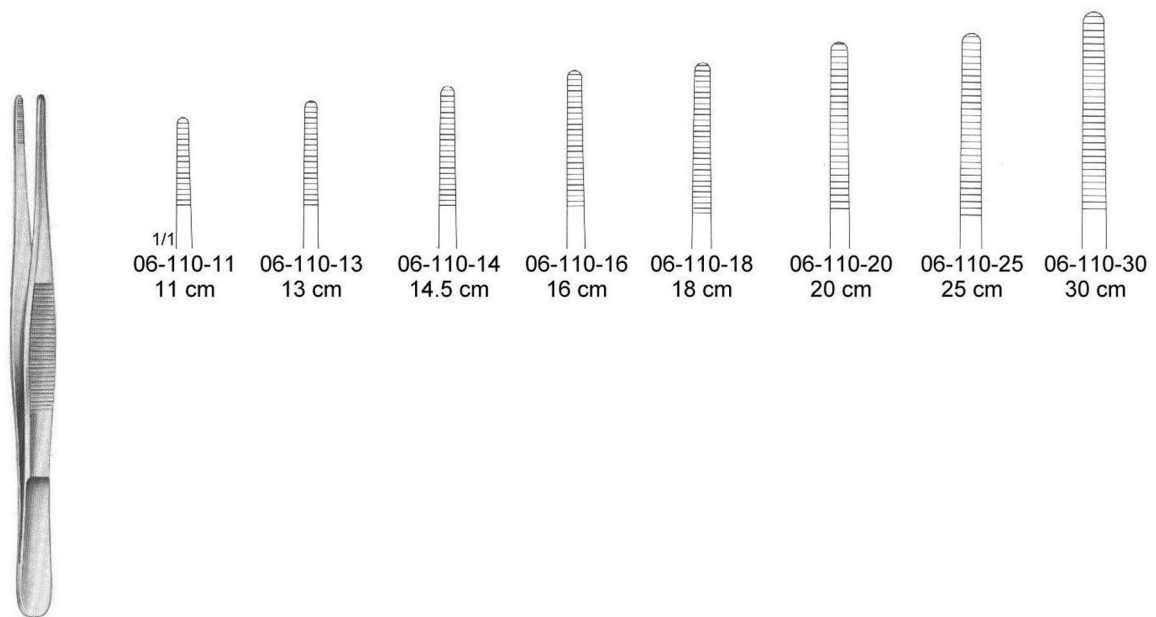

Narrow
06-110-11 - 06-110-30

SURGICAL DRESSING



Standard

06-115-10	10.5 cm
06-115-11	11.5 cm
06-115-13	13.0 cm
06-115-14	14.5 cm
06-115-16	16.0 cm
06-115-18	18.0 cm
06-115-20	20.0 cm
06-115-25	25.0 cm
06-115-30	30.0 cm

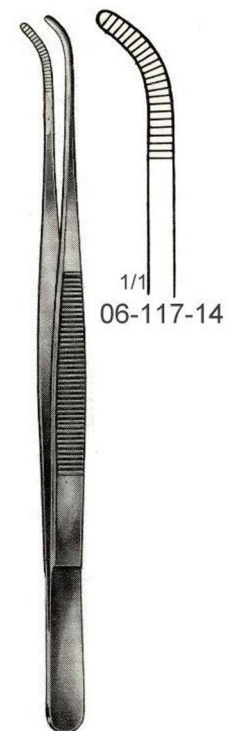

Narrow

06-117-10	10.5 cm
06-117-11	11.5 cm
06-117-13	13.0 cm
06-117-14	14.5 cm
06-117-16	16.0 cm
06-117-18	18.0 cm
06-117-20	20.0 cm
06-117-25	25.0 cm
06-117-30	30.0 cm

SURGICAL DRESSING

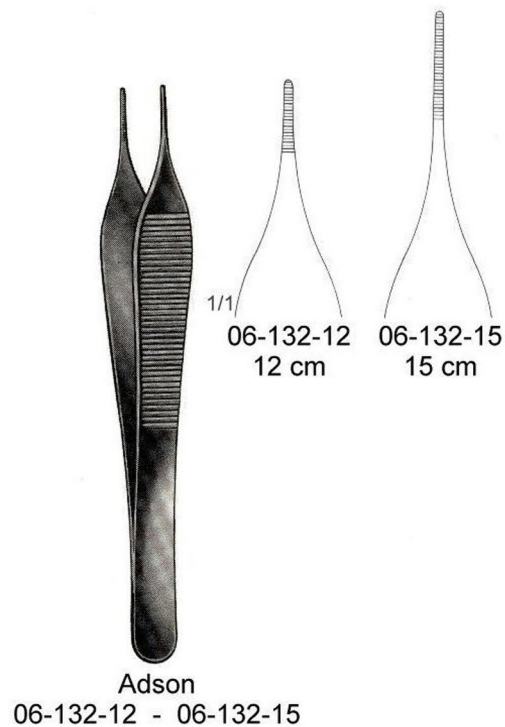
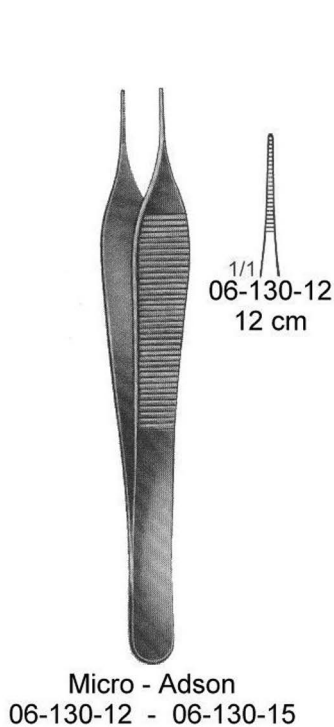
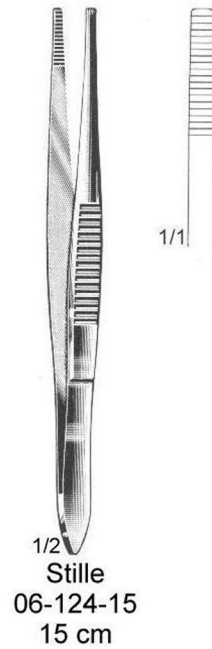
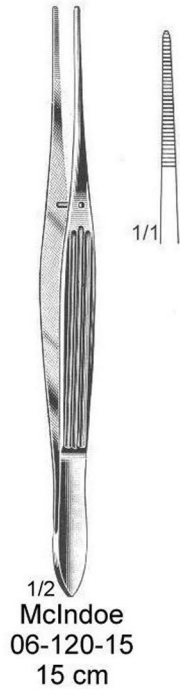

SURGICAL DRESSING



Modell USA
06-140-12 12.0 cm
06-140-13 13.0 cm
06-140-14 14.5 cm
06-140-15 15.5 cm
06-140-18 18.0 cm
06-140-21 21.0 cm
06-140-25 25.0 cm
06-140-31 31.0 cm



Modell USA
06-142-12 12.0 cm
06-142-13 13.0 cm
06-142-14 14.5 cm
06-142-15 15.5 cm



1/2
Ewald (Hudson)
06-146-12
12 cm

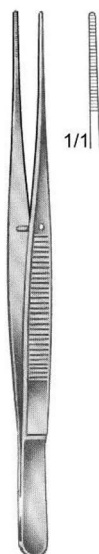

Semken
06-150-12 12 cm
06-150-15 15 cm

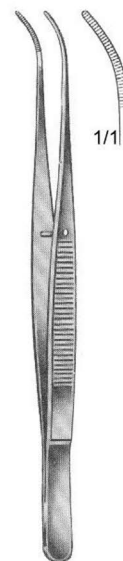

Semken
06-151-12 12 cm
06-151-15 15 cm

SURGICAL DRESSING

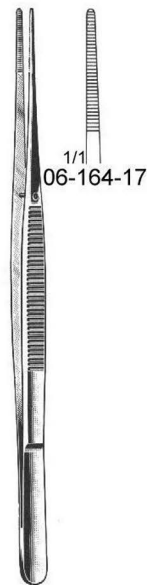

Taylor
06-164-17 - 06-165-17
17 cm

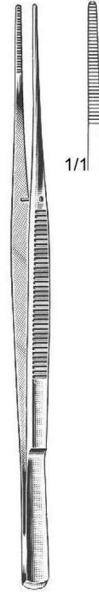

Taylor
06-170-17
17.5 cm



Taylor
06-170-18
18.5 cm



06-174-06 - 06-174-10
15.5 cm

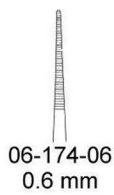

06-174-06
0.6 mm

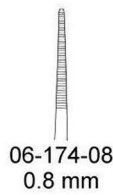

06-174-08
0.8 mm

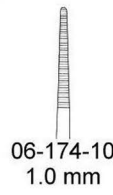

06-174-10
1.0 mm



Gerald
06-176-18 - 06-177-18
18 cm



06-176-18

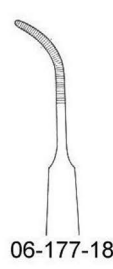

06-177-18

SURGICAL DRESSING

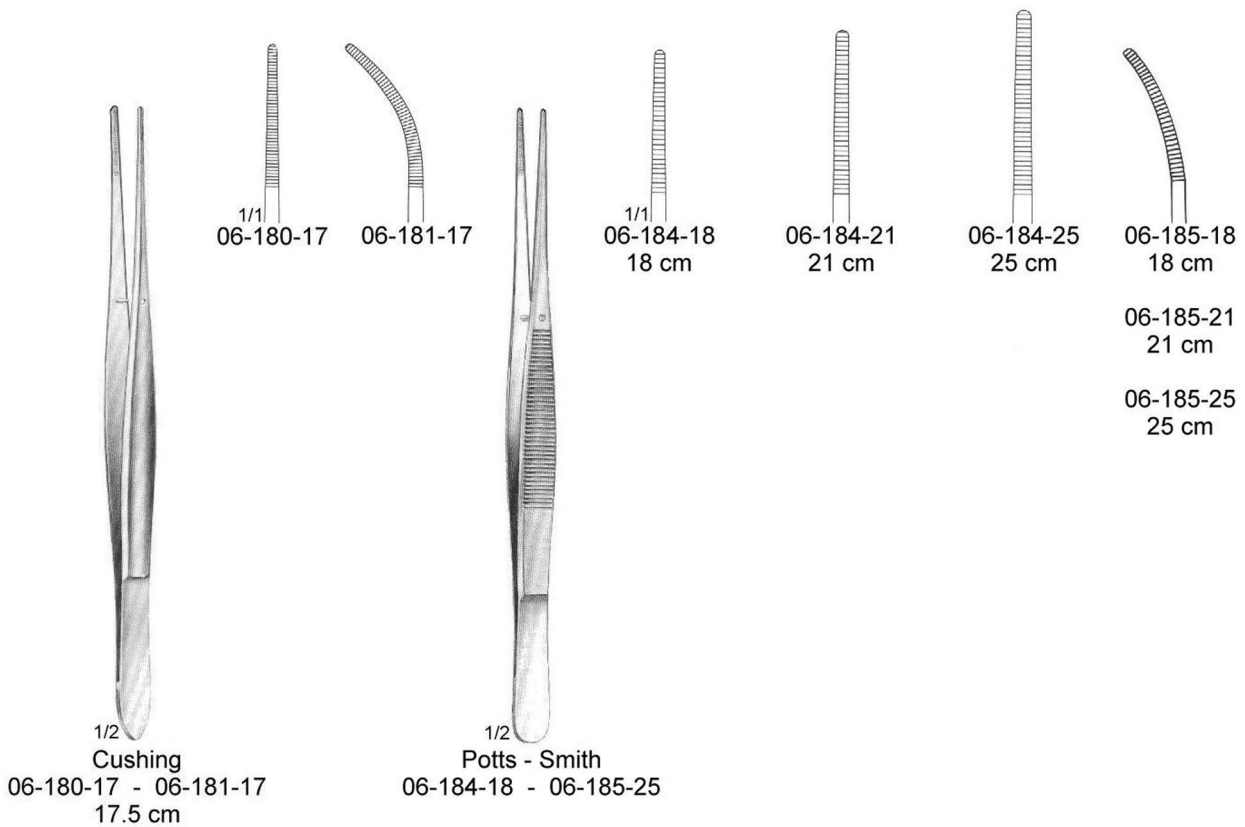

SURGICAL DRESSING

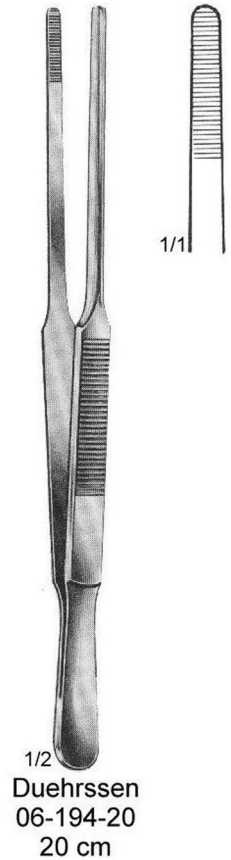
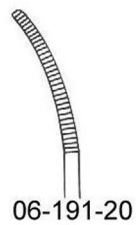
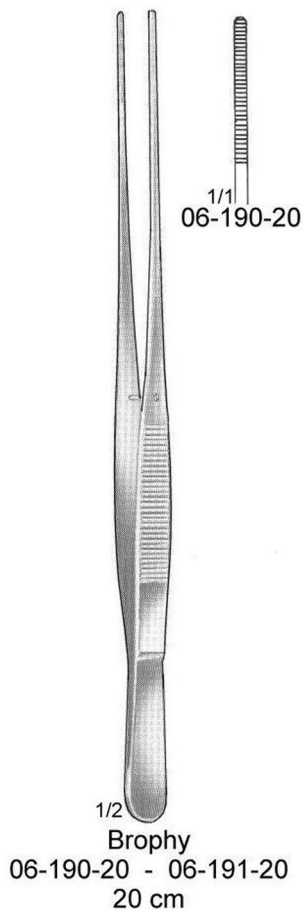

SURGICAL DRESSING

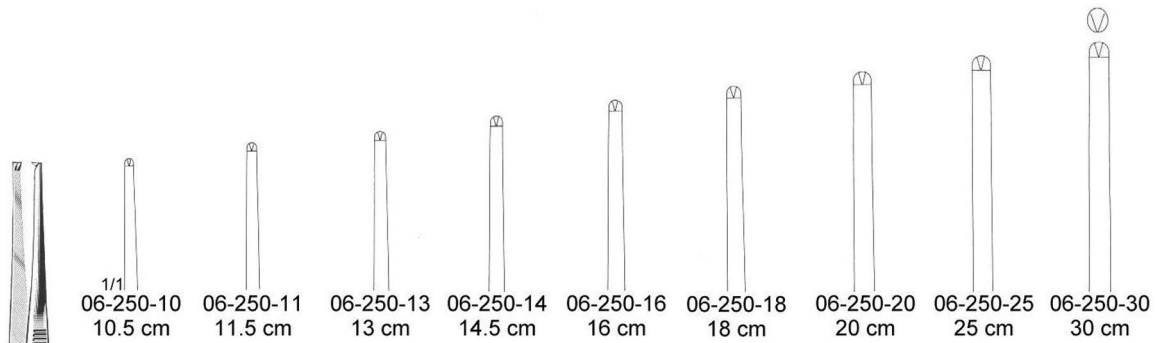

1/2
06-250-10 - 06-250-30
1:2 Teeth

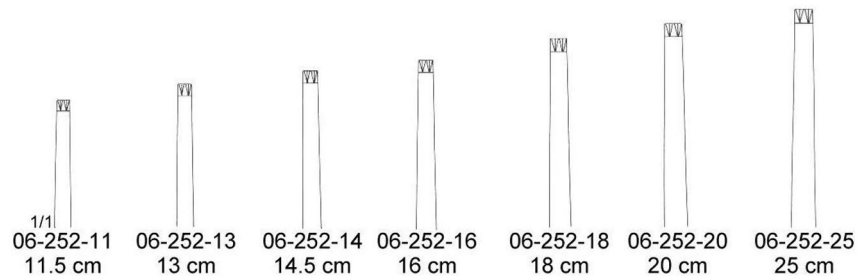

1/2
06-252-11 - 06-252-30
2:3 Teeth

SURGICAL DRESSING

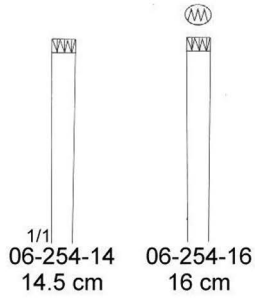

06-254-13 13.0 cm
06-254-14 14.5 cm
06-254-16 16.0 cm
3:4 Teeth

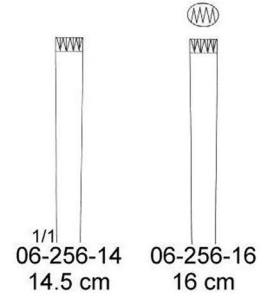

06-256-13 13.0 cm
06-256-14 14.5 cm
06-256-16 16.0 cm
4:5 Teeth

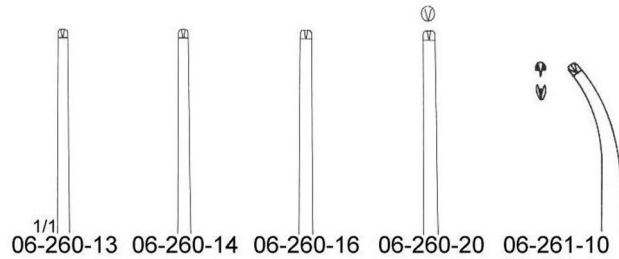

06-260-10 10.5 cm
06-260-11 11.5 cm
06-260-13 13.0 cm
06-260-14 14.5 cm
06-260-16 16.0 cm
06-260-18 18.0 cm
06-260-20 20.0 cm
06-260-25 25.0 cm
06-260-30 30.0 cm
1:2 Teeth

06-261-10 10.5 cm
06-261-11 11.5 cm
06-261-13 13.0 cm
06-261-14 14.5 cm
06-261-16 16.0 cm
06-261-18 18.0 cm
06-261-20 20.0 cm
06-261-25 25.0 cm
06-261-30 30.0 cm
1:2 Teeth

SURGICAL DRESSING

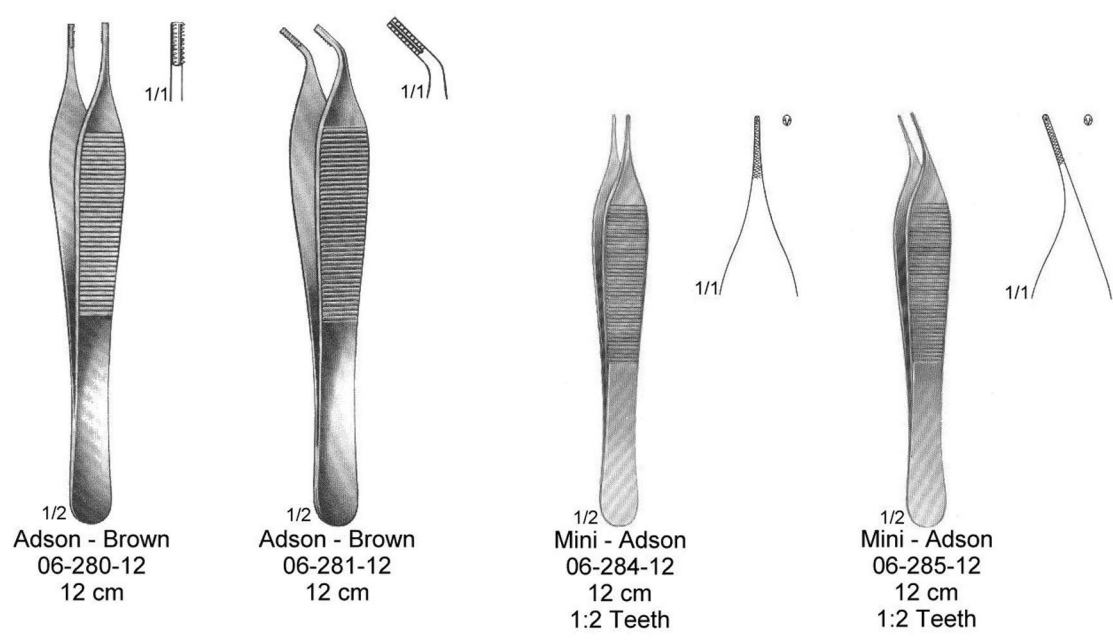
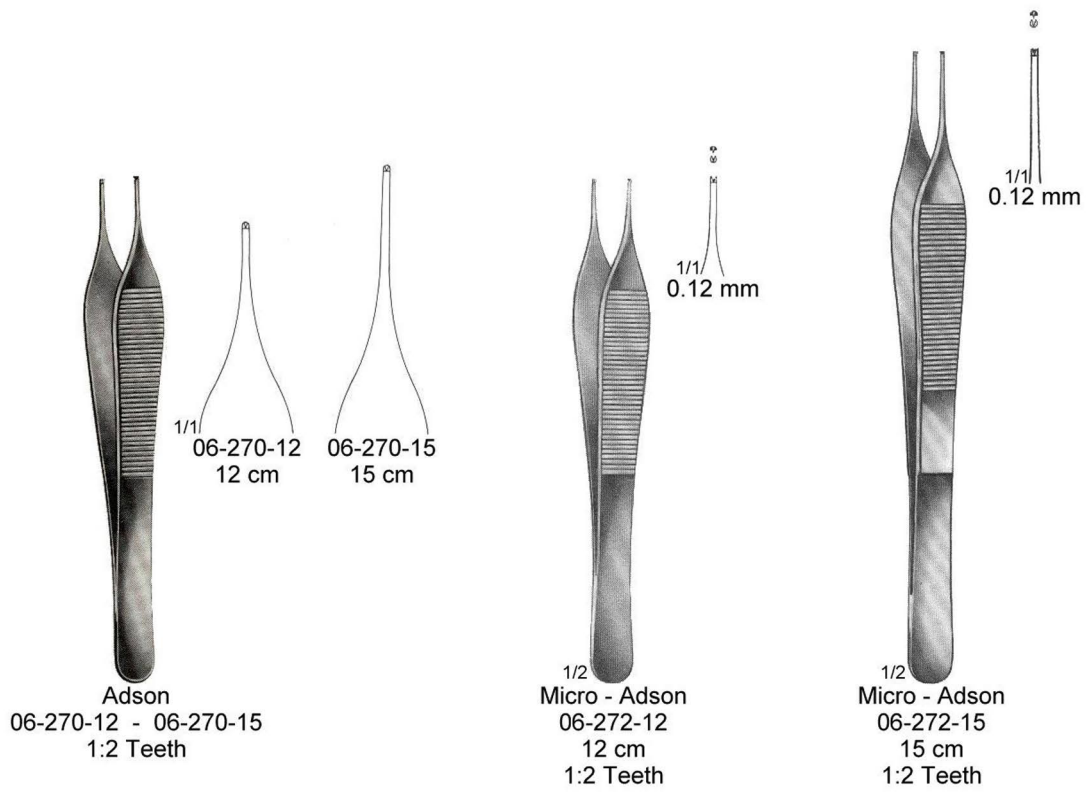

SURGICAL DRESSING

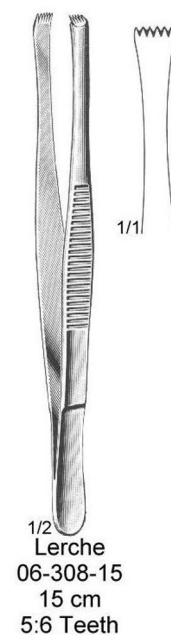
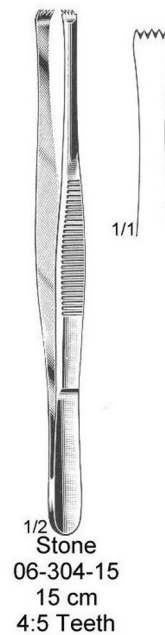
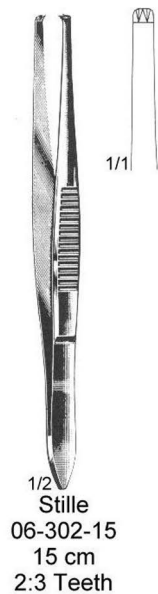
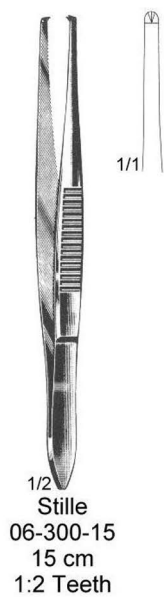
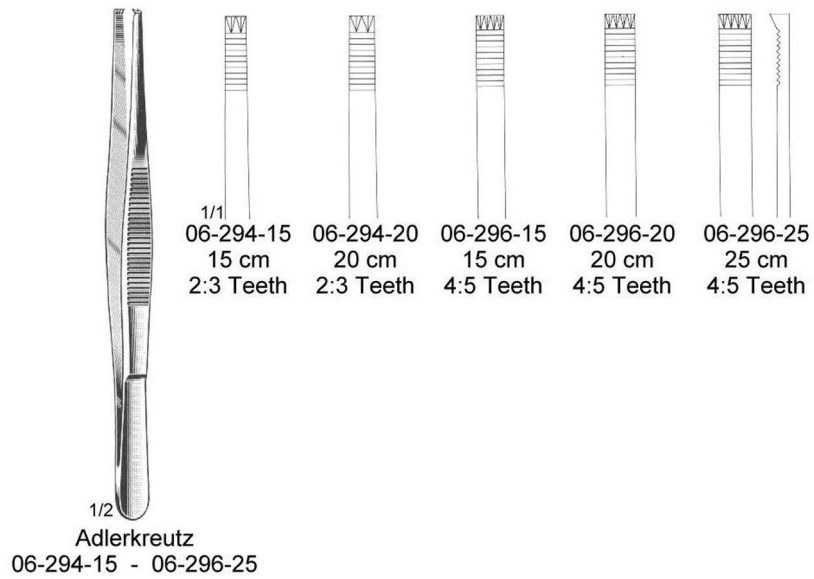
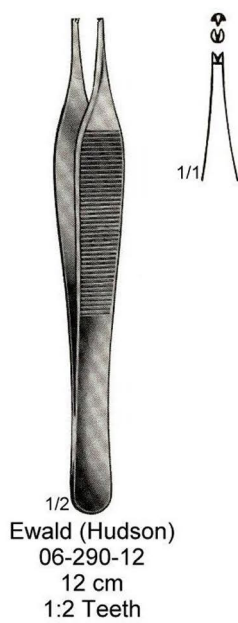

SURGICAL DRESSING

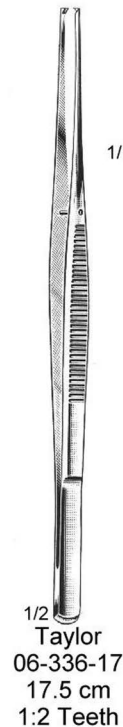
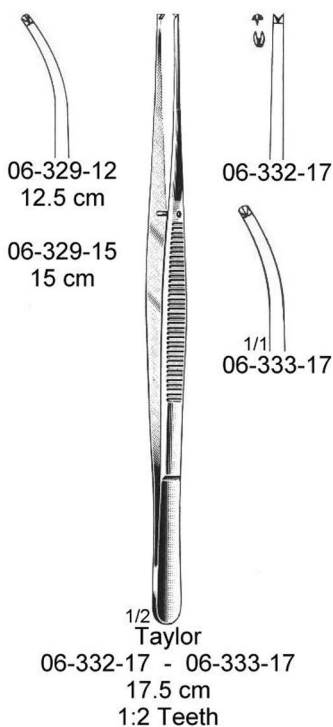
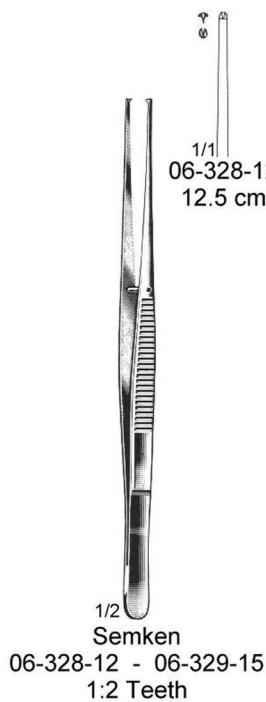
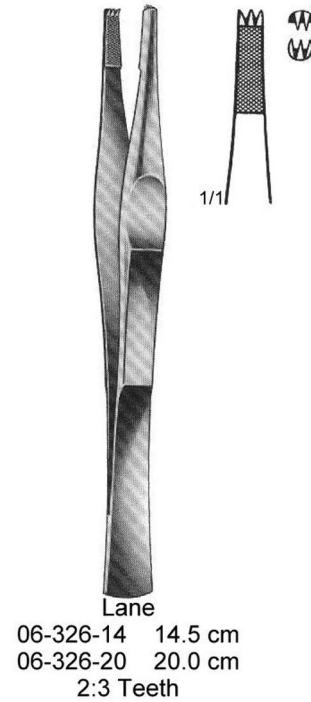
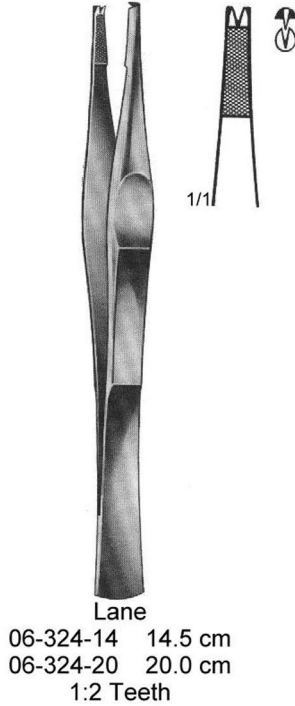
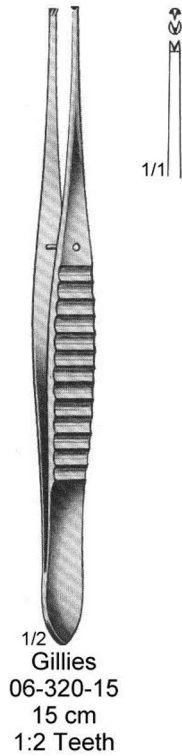

SURGICAL DRESSING

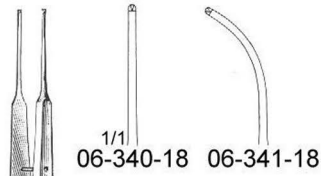

1/2
Gerald
06-340-18 - 06-341-18
18 cm
1:2 Teeth

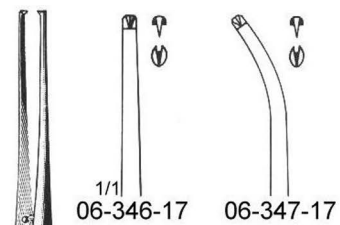

1/2
Cushing
06-346-17 - 06-347-17
17.5 cm
1:2 Teeth

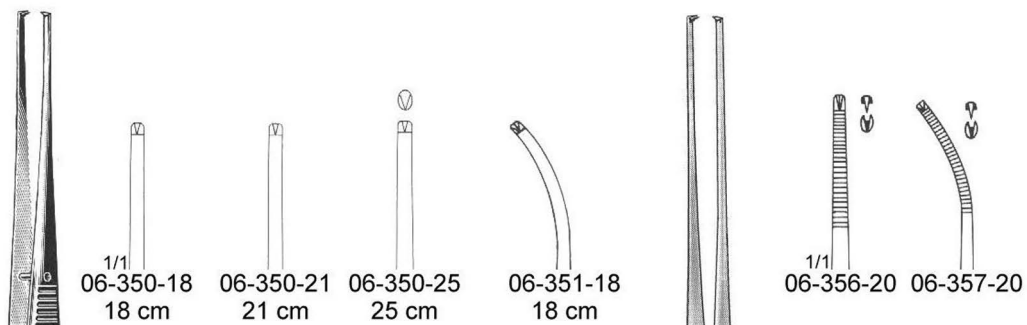

Potts - Smith
06-350-18 - 06-351-25
1:2 Teeth

1/2
Brophy
06-356-20 - 06-357-20
20 cm
1:2 Teeth

SURGICAL DRESSING

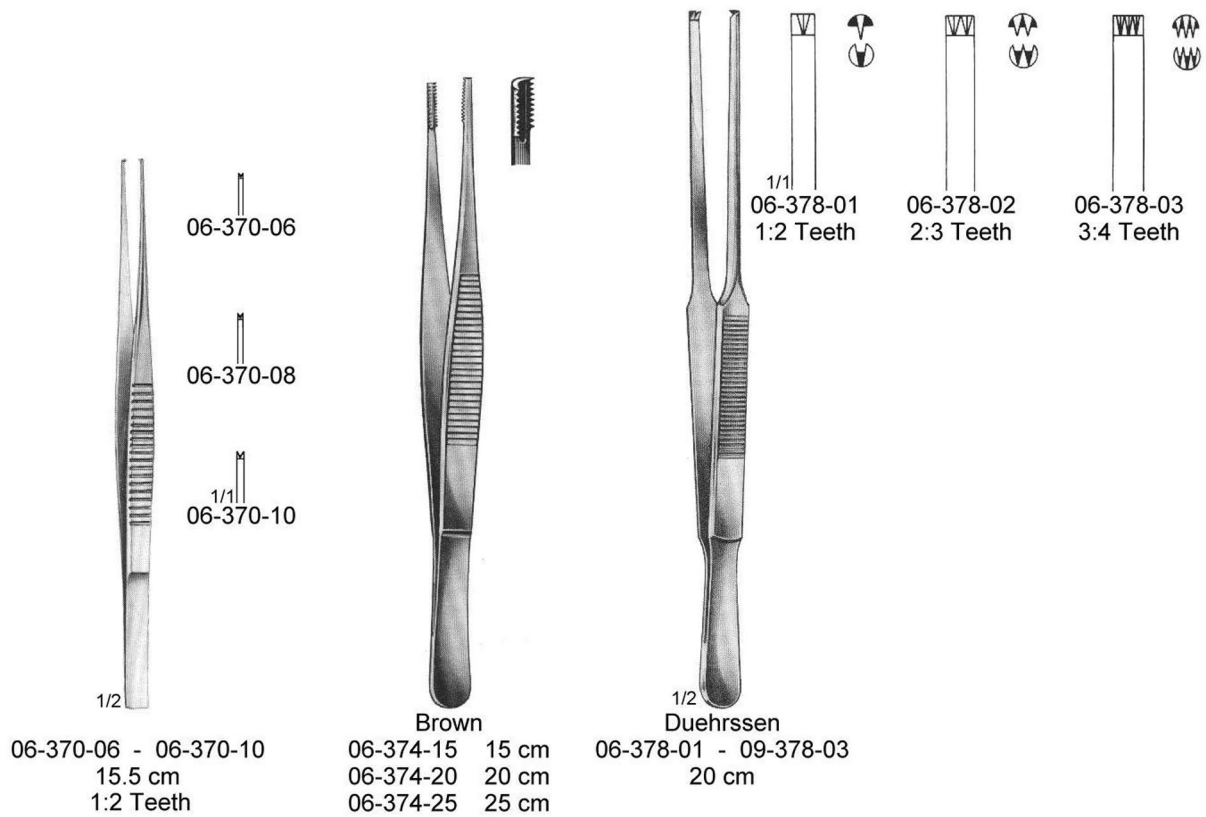

SURGICAL DRESSING

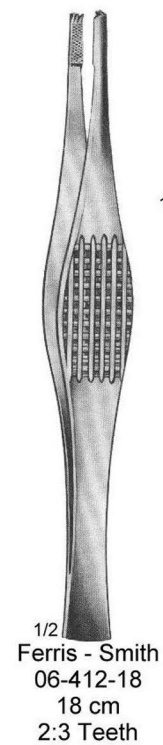
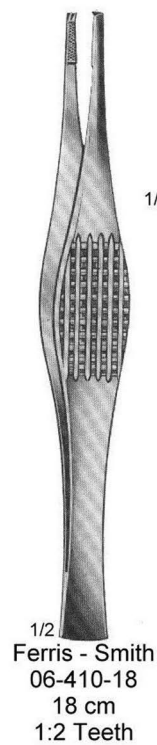
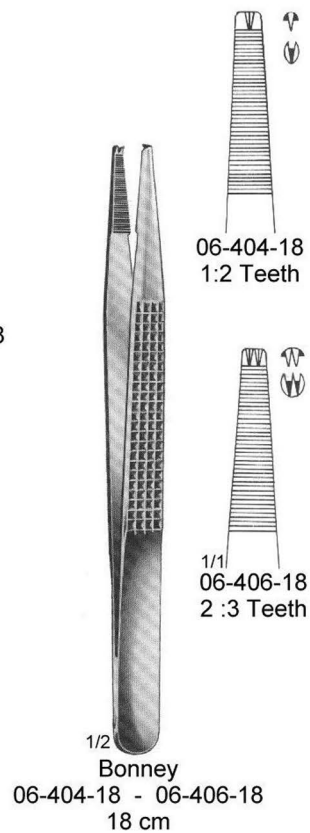
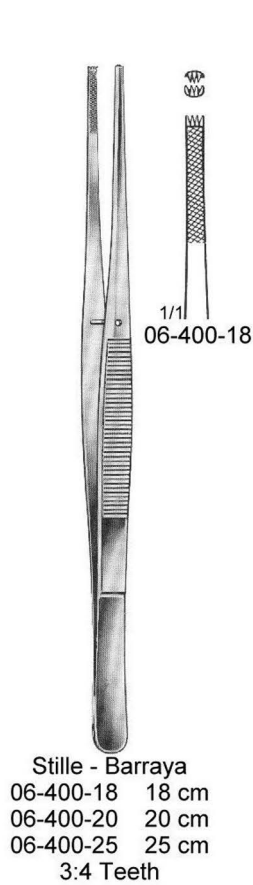

SURGICAL DRESSING

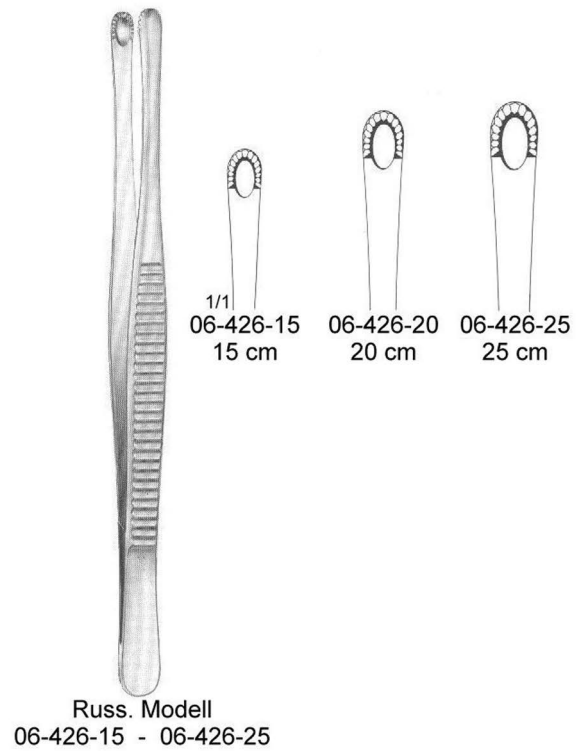
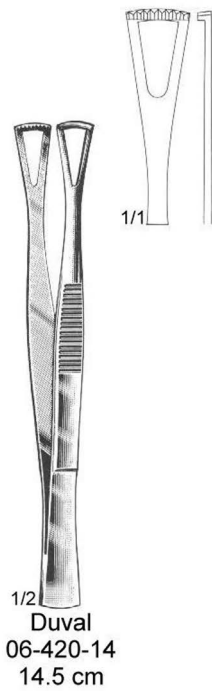

SURGICAL DRESSING



Durante
06-430-14 - 06-430-20

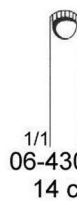

1/1
06-430-14
14 cm



06-430-16
16 cm



06-430-20
20 cm

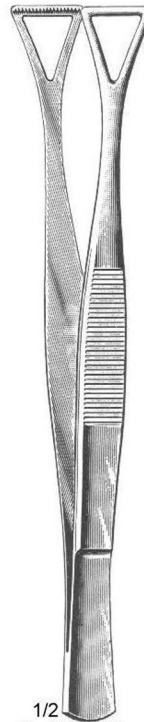

1/2
Collin - Duval
06-436-14 - 06-436-27
20 cm



06-436-14
14 mm



06-436-18
18 mm

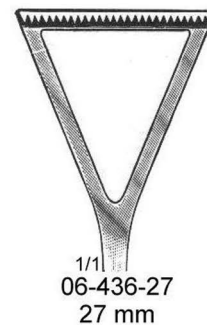

1/1
06-436-27
27 mm

SURGICAL DRESSING

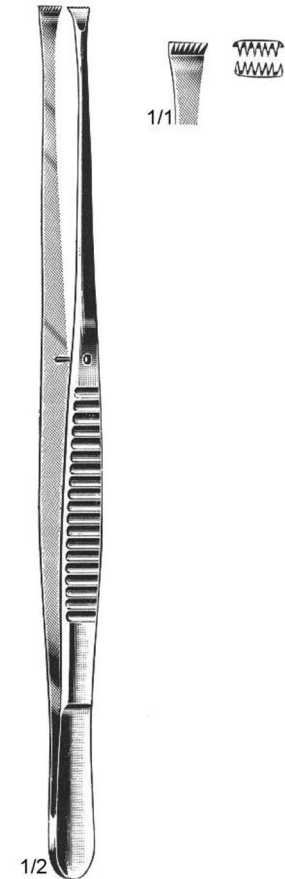
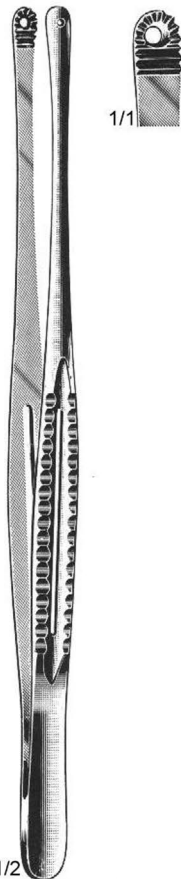

SURGICAL DRESSING



06-460-01
11.5 cm



06-460-02
11 cm



06-460-03
11 cm



06-460-04
11.5 cm

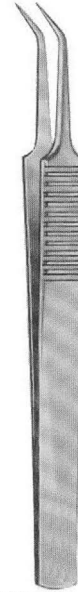

06-460-05
10.5 cm

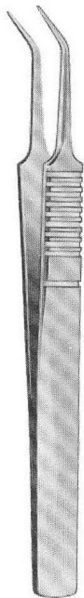

06-460-06
10.5 cm

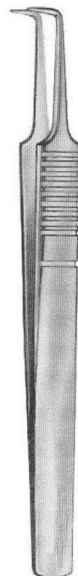

06-460-07
11.5 cm

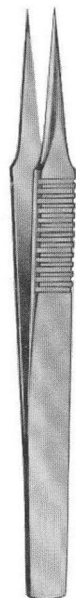

06-460-08
11.5 cm

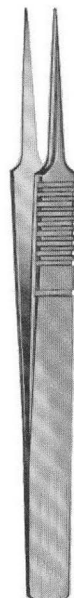

06-460-09
11.5 cm

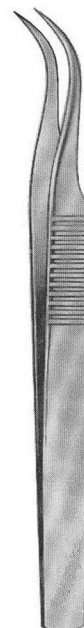

06-460-10
10.5 cm

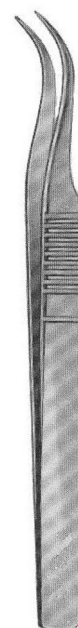

06-460-11
10.5 cm

SURGICAL DRESSING

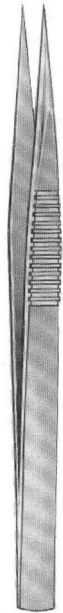

06-460-12
12.5 cm



06-460-13
12.5 cm

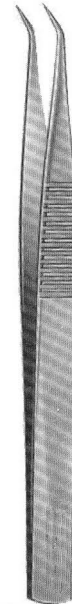

06-460-14
12.5 cm



06-462-01
10 cm

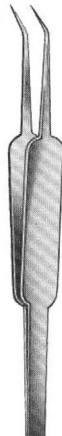

06-462-02
10 cm



06-462-03
10 cm

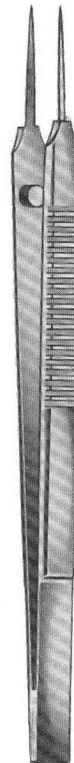

06-466-01
14 cm

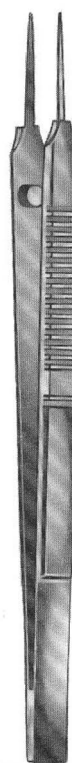

06-466-02
14 cm

SURGICAL DRESSING

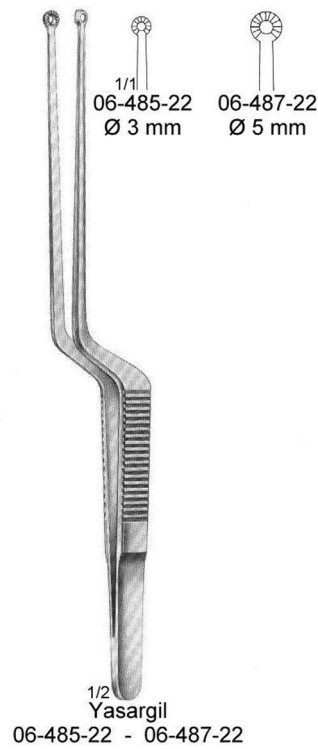
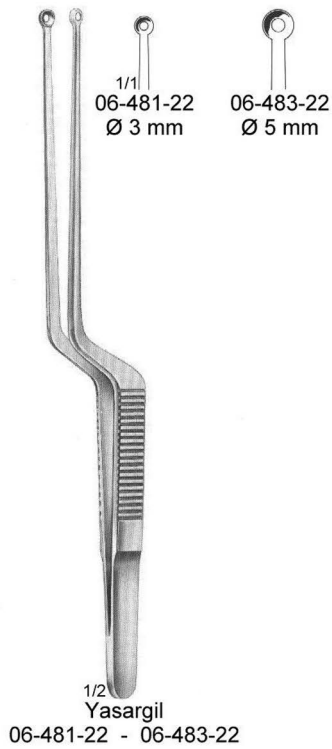

SURGICAL DRESSING



1/2
Graefe
06-502-10 - 06-515-10
10.5 cm

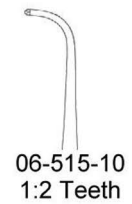
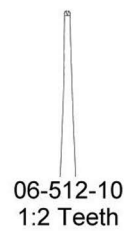
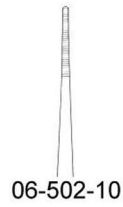

SURGICAL DRESSING



8.0 cm 06-520-08
9.0 cm 06-520-09
10.5 cm 06-520-10
11.5 cm 06-520-11
12.5 cm 06-520-12
14.5 cm 06-520-14

without pin

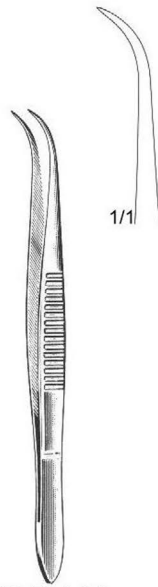

06-521-08
06-521-09
06-521-10
06-521-11
06-521-12
06-521-14

without pin

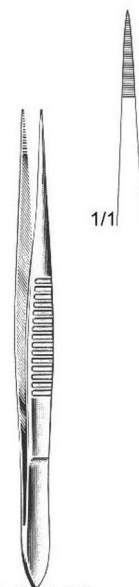

06-524-08
06-524-09
06-524-10
06-524-11
06-524-12
06-524-14

without pin

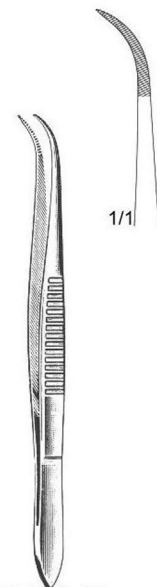

06-525-08
06-525-09
06-525-10
06-525-11
06-525-12
06-525-14

without pin

8.0 cm 06-530-08
9.0 cm 06-530-09
10.5 cm 06-530-10
11.5 cm 06-530-11
12.5 cm 06-530-12
14.5 cm 06-530-14

with pin

06-531-08
06-531-09
06-531-10
06-531-11
06-531-12
06-531-14

with pin

06-534-08
06-534-09
06-534-10
06-534-11
06-534-12
06-534-14

with pin

06-535-08
06-535-09
06-535-10
06-535-11
06-535-12
06-535-14

with pin

SURGICAL DRESSING

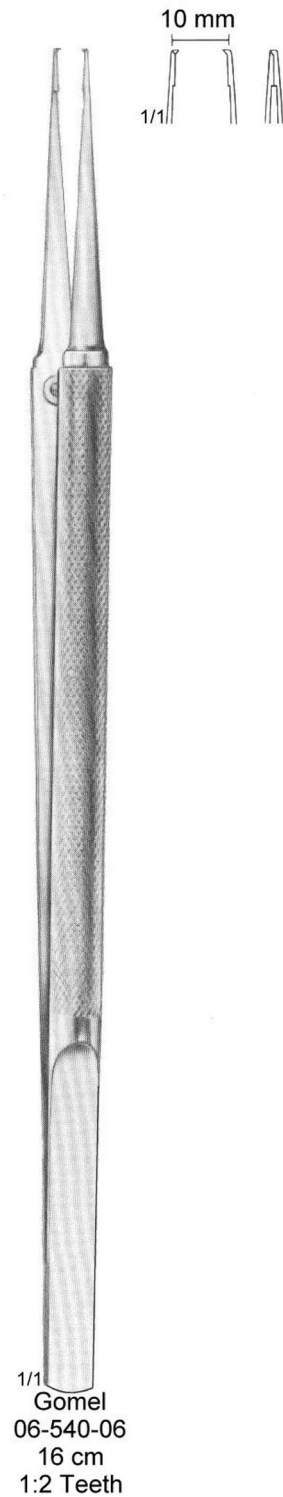
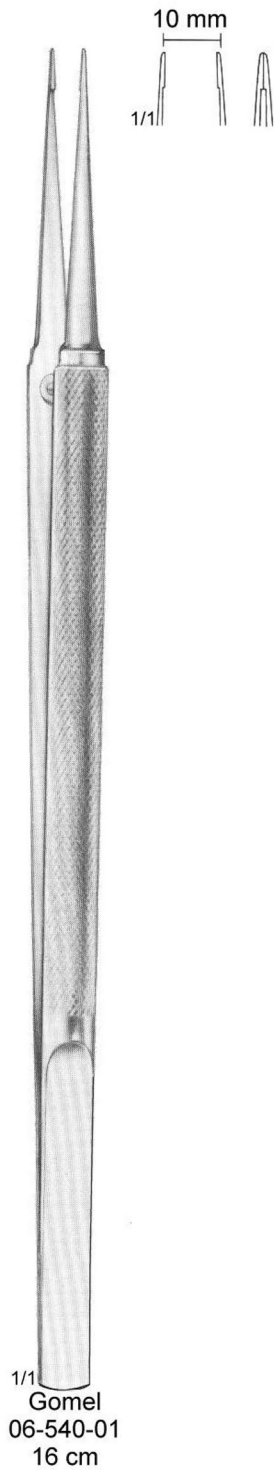

SURGICAL DRESSING

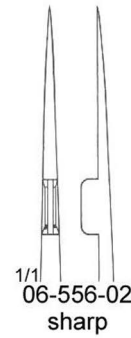
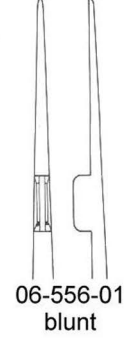
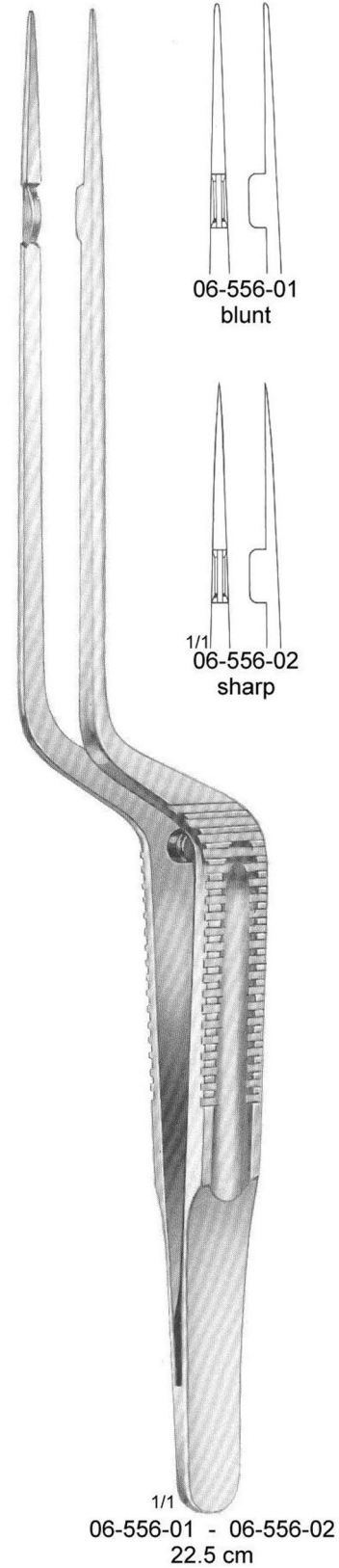
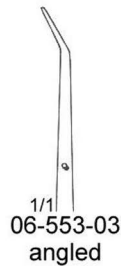
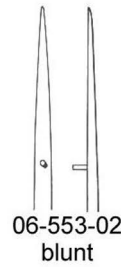
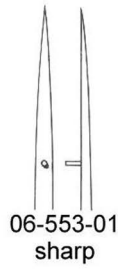
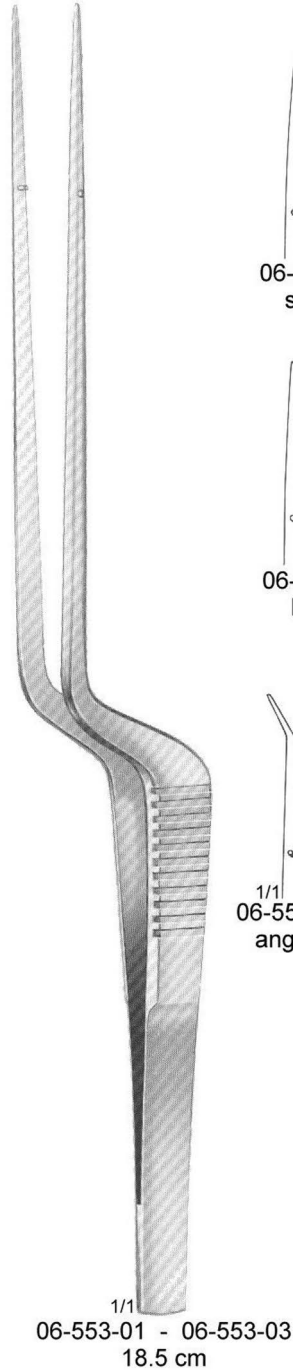
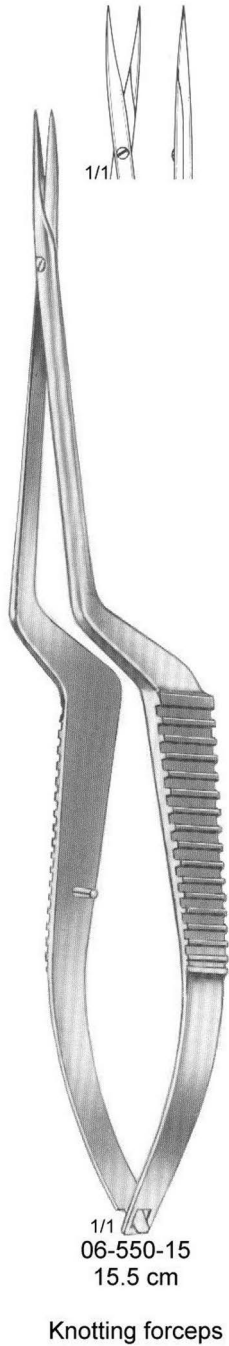

SURGICAL DRESSING

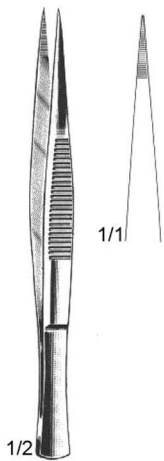

06-570-12
12.5 cm



06-574-10
10 cm



06-576-10
10 cm



06-578-07
7.5 cm



06-578-09
9 cm



06-578-11
11.5 cm

Feilchenfeld

06-578-07 - 06-578-11

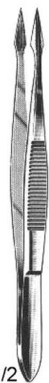

06-580-10 - 06-581-10
10.5 cm

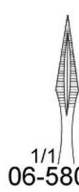

06-580-10



06-581-10

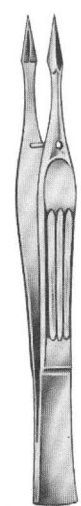

Walter - Carmalt
06-584-10
10.5 cm



Walter - Carmalt
06-585-10
10.5 cm

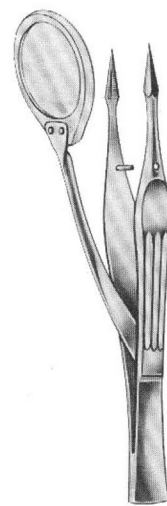

06-588-10
10.5 cm

SURGICAL DRESSING

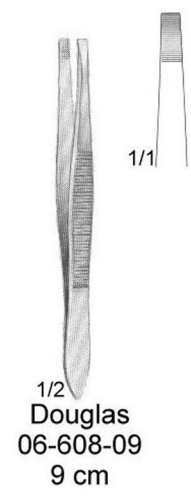
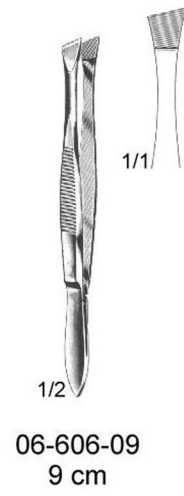
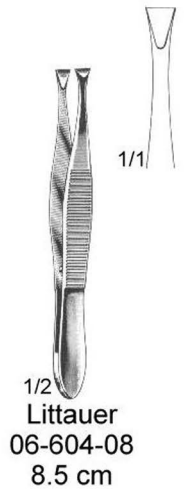
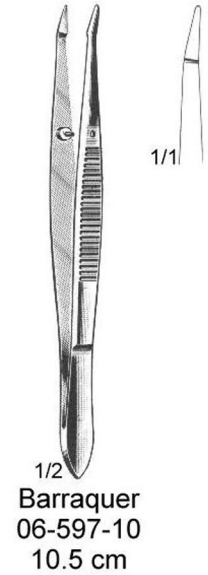
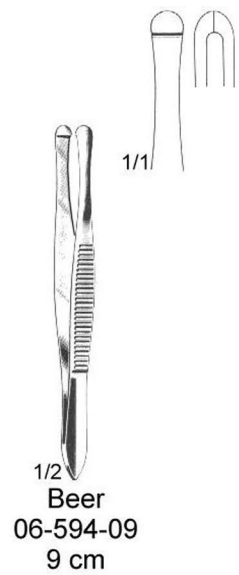
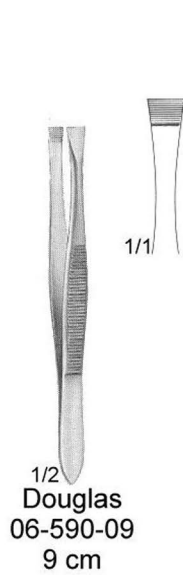

SURGICAL DRESSING

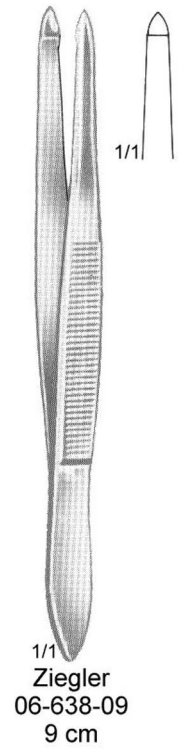
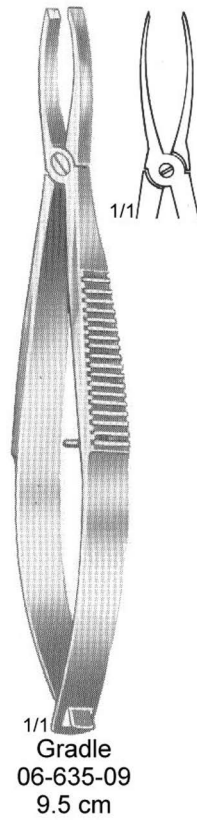
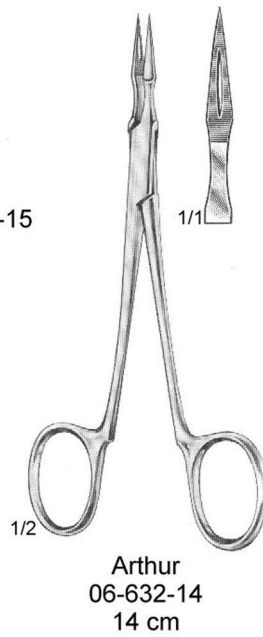
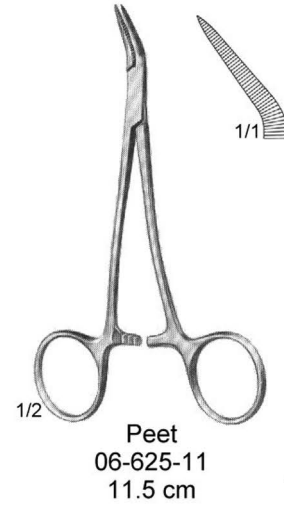
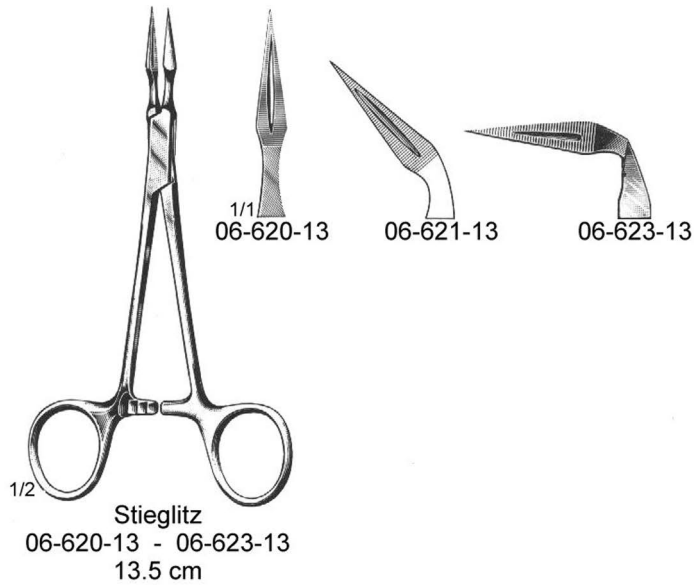

SURGICAL DRESSING

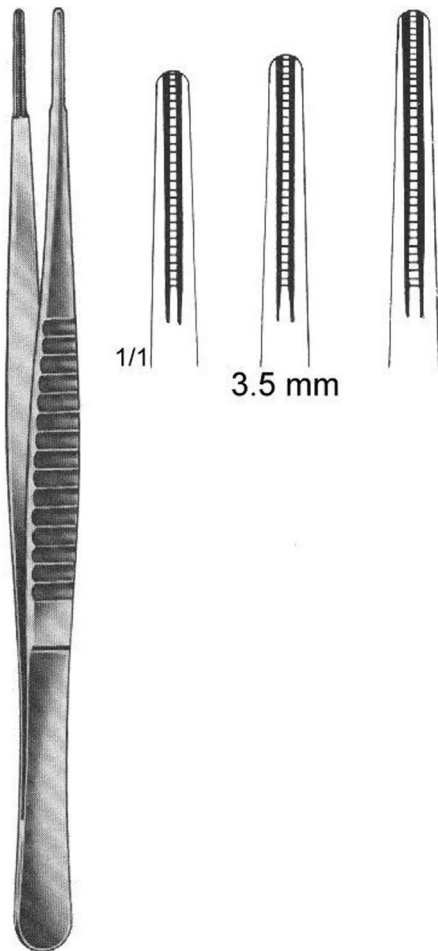

De Bakey
06-656-20 20 cm
06-656-24 24 cm
06-656-30 30 cm

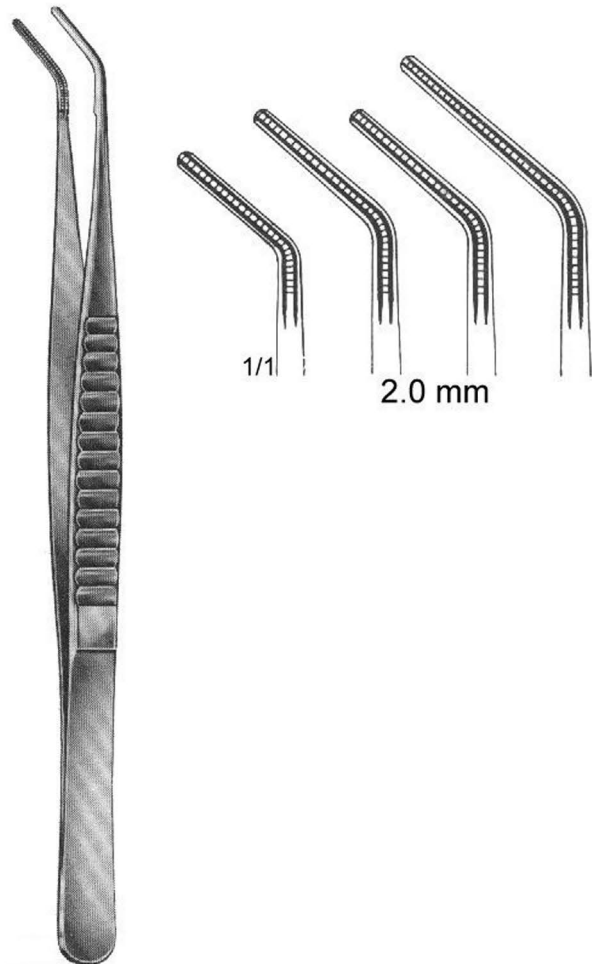

De Bakey
06-659-16 16 cm
06-659-20 20 cm
06-659-24 24 cm
06-659-30 30 cm

SURGICAL DRESSING

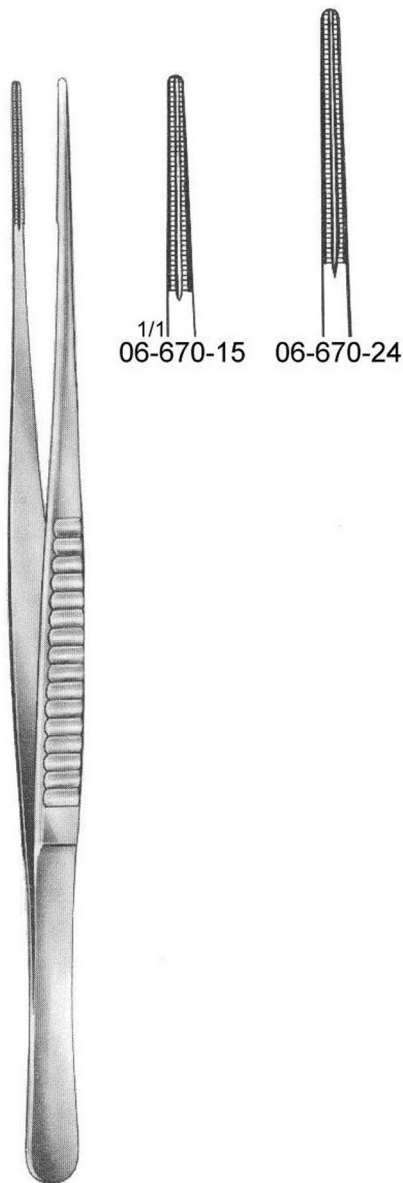

1/1
06-670-15 06-670-24

Glassman
06-670-15 15 cm
06-670-24 24 cm

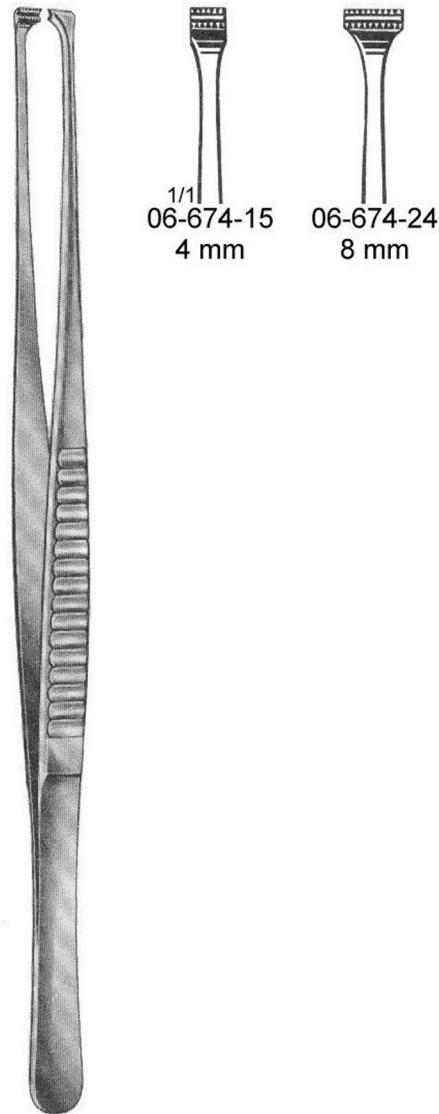

1/1
06-674-15 4 mm
06-674-24 8 mm

Glassman
06-674-15 15 cm
06-674-24 24 cm

SURGICAL DRESSING

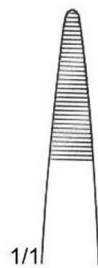

1/1

Engl. Modell

06-680-12	12.5 cm
06-680-15	15.0 cm
06-680-18	18.0 cm
06-680-20	20.0 cm

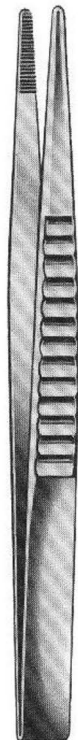

1/1

Engl. Modell

06-682-12	12.5 cm
06-682-15	15.0 cm
06-682-18	18.0 cm
06-682-20	20.0 cm
06-682-25	25.0 cm
06-682-30	30.0 cm

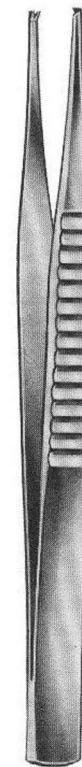

1/1

Treves

06-688-12	12.5 cm
06-688-15	15.0 cm
06-688-18	18.0 cm
06-688-20	20.0 cm
1:2 Teeth	

SURGICAL DRESSING

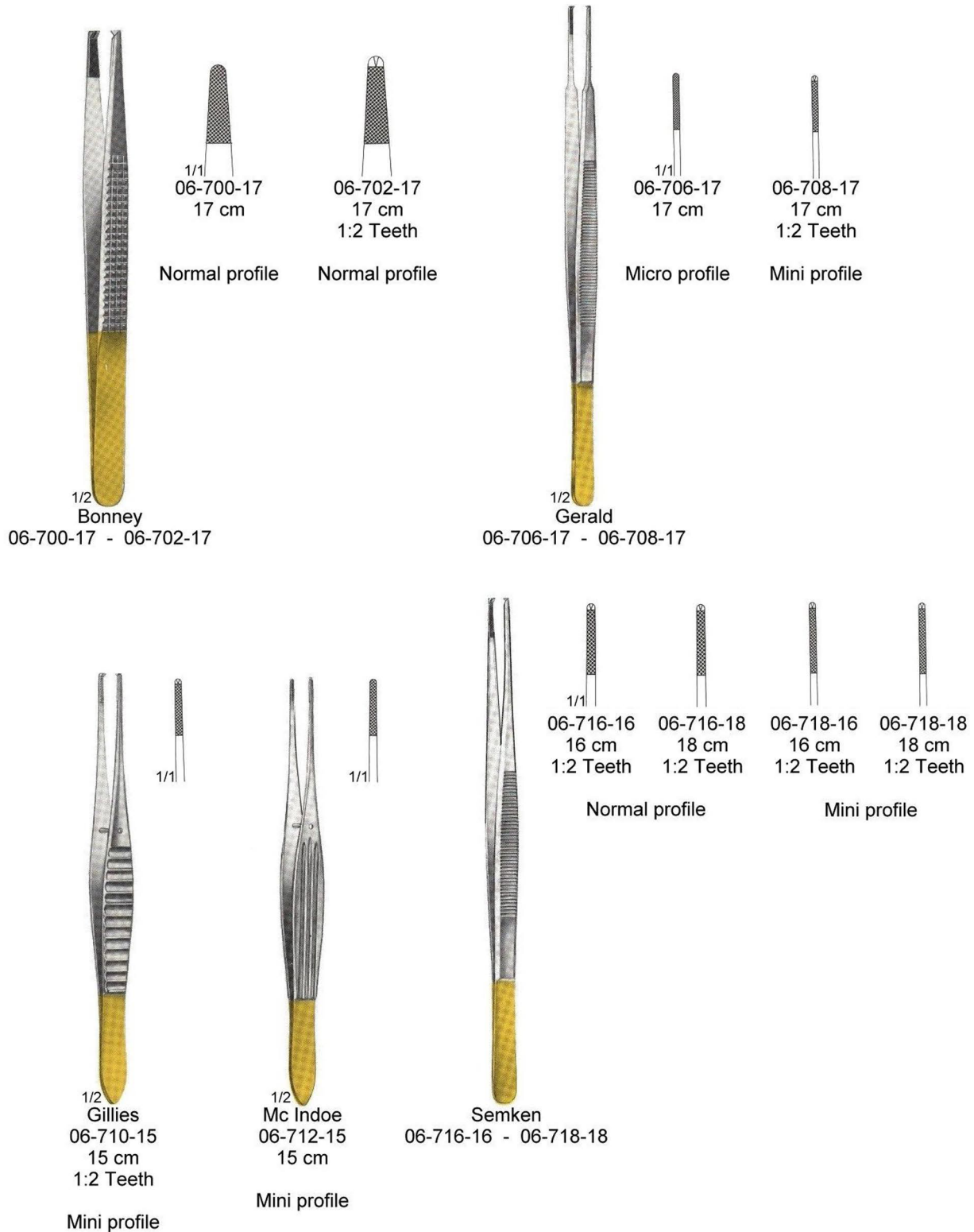



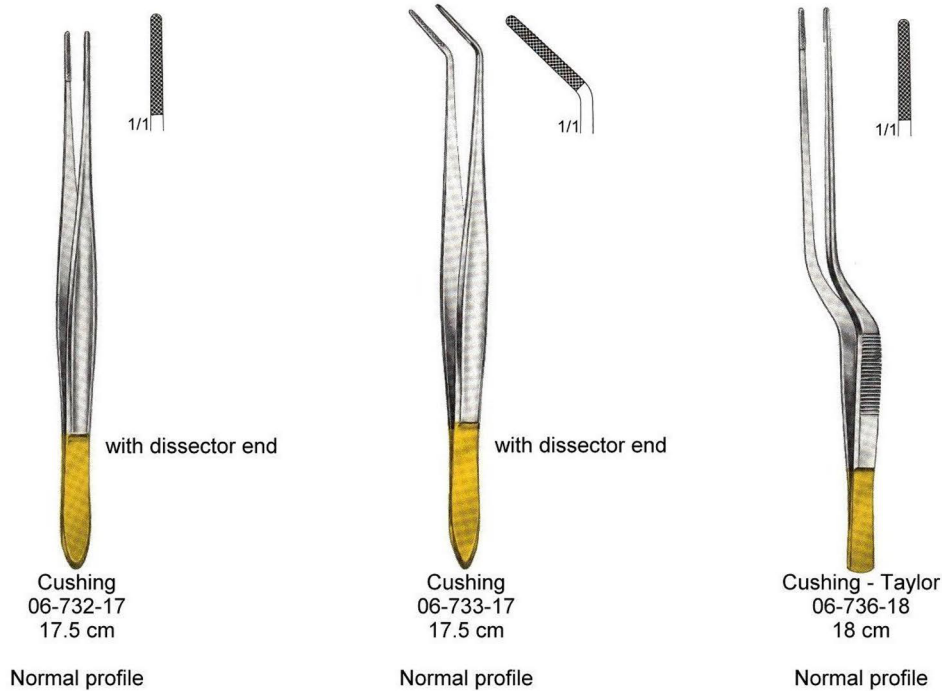
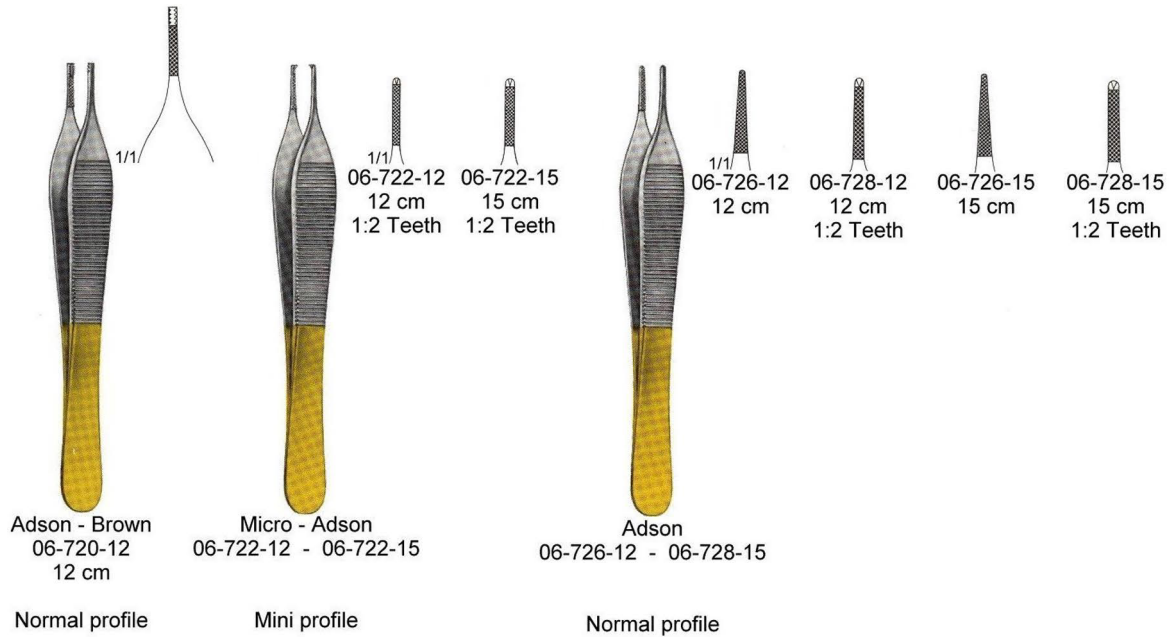

SURGICAL DRESSING



SURGICAL DRESSING









Potts - Smith
06-740-15 - 06-742-25

 1/1 06-740-15 15 cm	 06-740-18 18 cm	 06-740-20 20 cm	 06-740-23 23 cm	 06-740-25 25 cm
--	---	---	---	---

Normal profile



Oehler
06-742-14 - 06-742-30

 1/1 06-742-14 14 cm 1:2 Teeth	 06-742-16 16 cm 1:2 Teeth	 06-742-18 18 cm 1:2 Teeth	 06-742-20 20 cm 1:2 Teeth	 06-742-25 25 cm 1:2 Teeth	 06-742-30 30 cm 1:2 Teeth
---	--	--	---	--	--

Normal profile

SURGICAL DRESSING

Knotting forceps

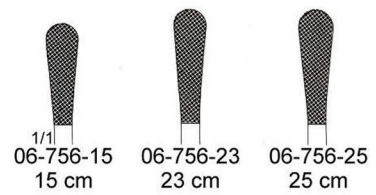
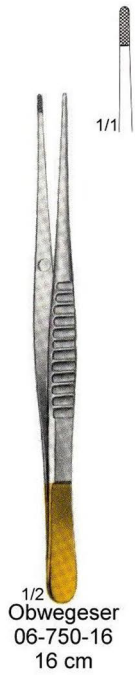

Normal profile

SURGICAL DRESSING



De Bakey
06-760-15 - 06-764-24

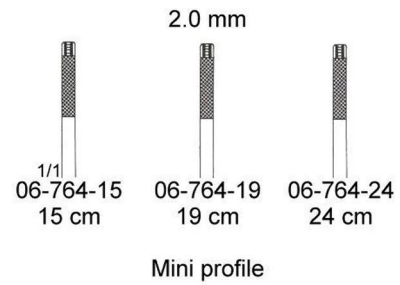
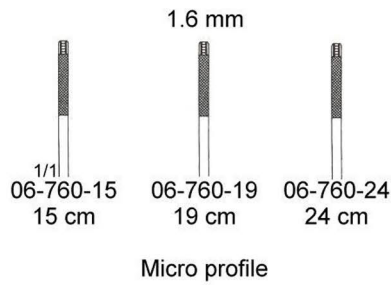

SURGICAL DRESSING



1/2
JABOMA-TC
06-770-18
18 cm



1/2
JABOMA-TC
06-776-18
18 cm
1:2 Teeth

Cleft Palate



1/2
JABOMA-TC
06-777-18
18 cm
1:2 Teeth



CONTACT US

 +62 856-6381-381

 inquiry@averonindonesia.com

 sales@averonindonesia.com

 www.averonindonesia.com

 Axa tower - Kuningan City Lt 45-7A Jl Prof. DR. Satrio, Kuningan, Kecamatan Setiabudi, Kota Jakarta Selatan, Daerah Khusus Ibukota Jakarta 12940.