



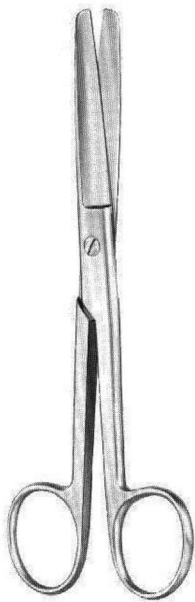
Scissors Instruments

 www.averonindonesia.com

SCISSORS

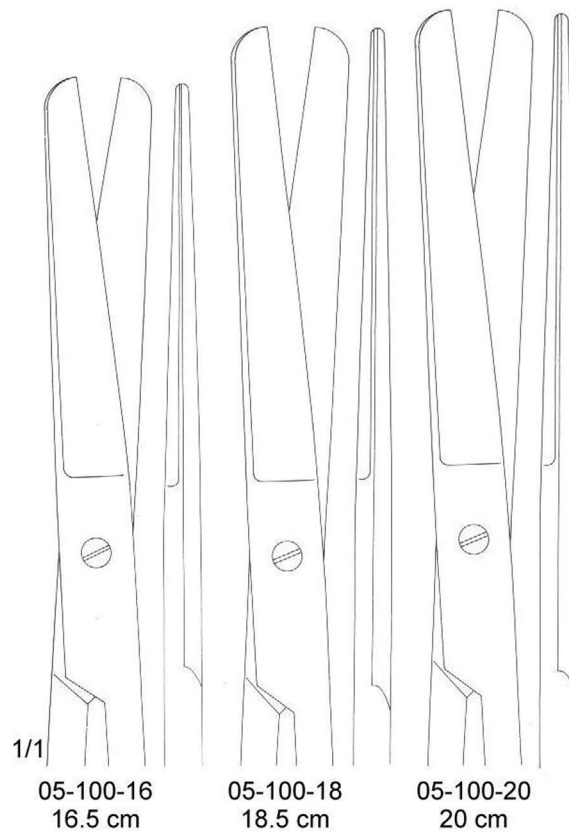
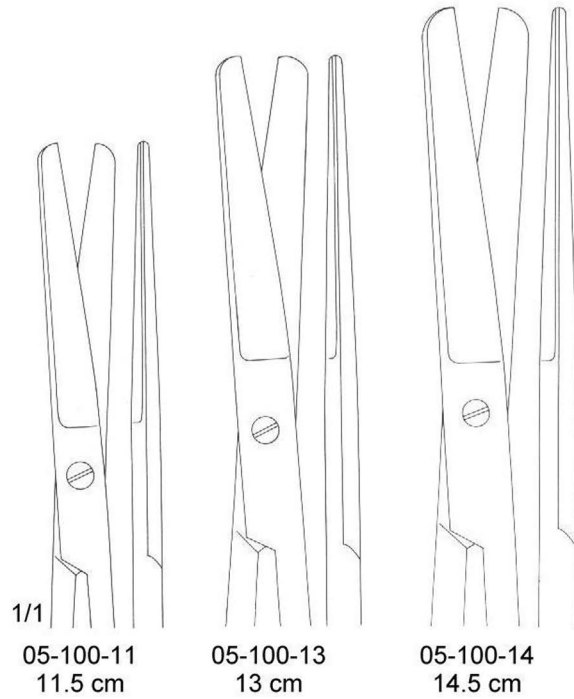


SCISSORS

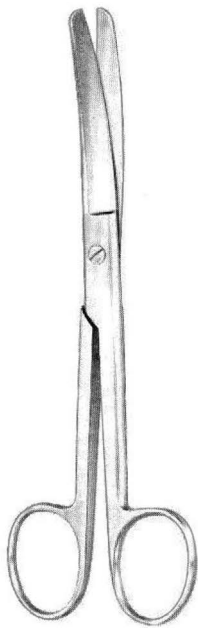


Standard

05-100-10	10.5 cm
05-100-11	11.5 cm
05-100-13	13.0 cm
05-100-14	14.5 cm
05-100-15	15.5 cm
05-100-16	16.5 cm
05-100-18	18.5 cm
05-100-20	20.0 cm

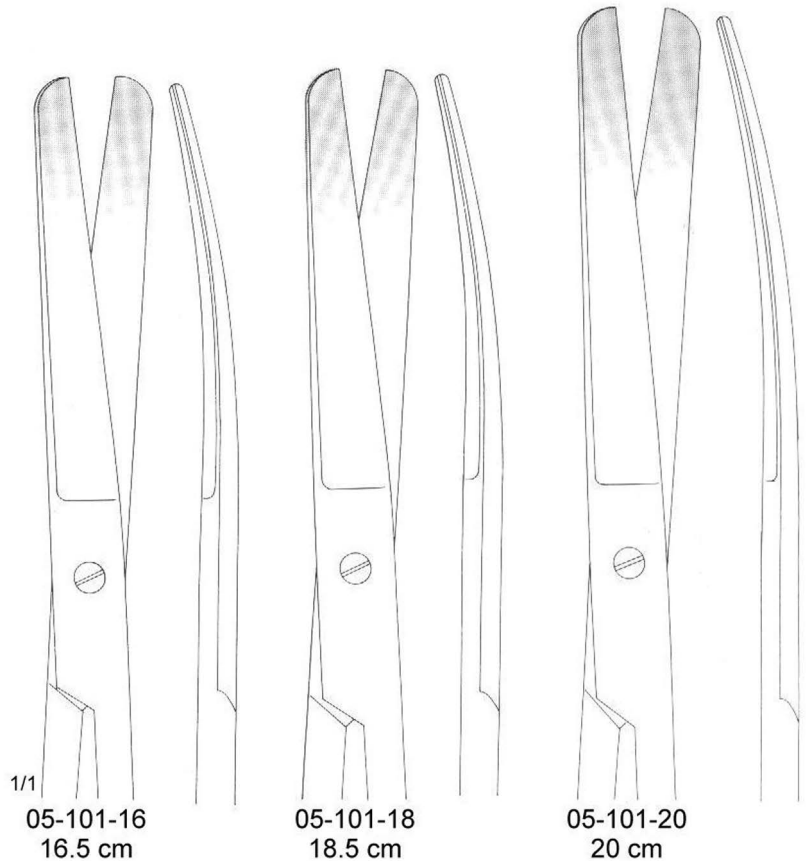
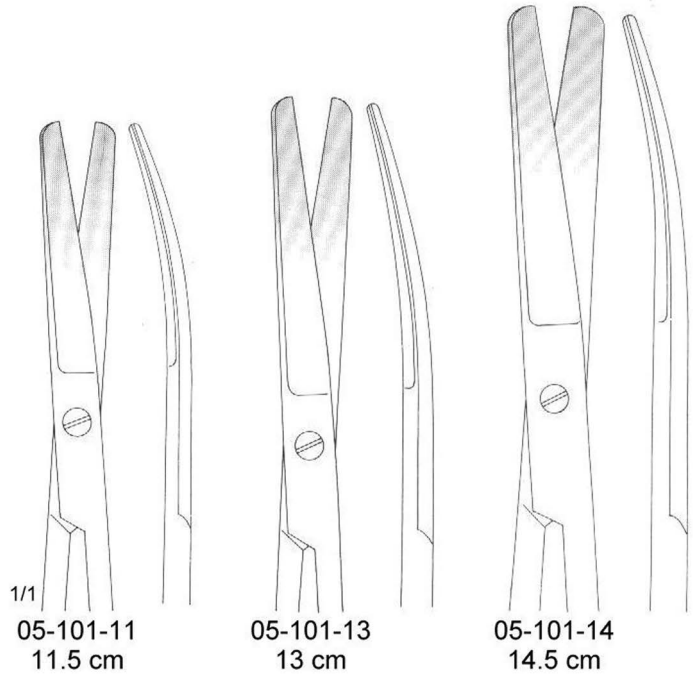


SCISSORS

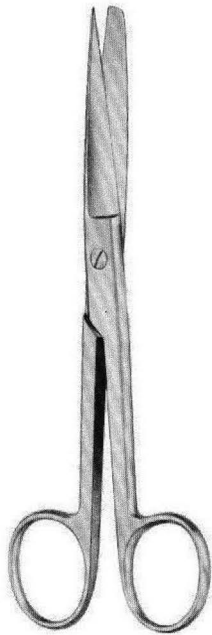


Standard

- 05-101-10 10.5 cm
- 05-101-11 11.5 cm
- 05-101-13 13.0 cm
- 05-101-14 14.5 cm
- 05-101-15 15.5 cm
- 05-101-16 16.5 cm
- 05-101-18 18.5 cm
- 05-101-20 20.0 cm

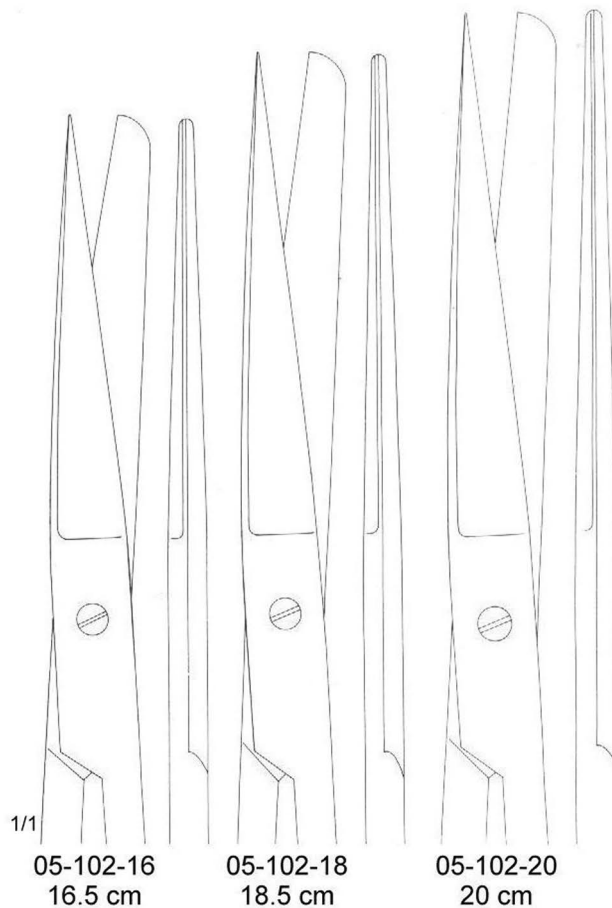
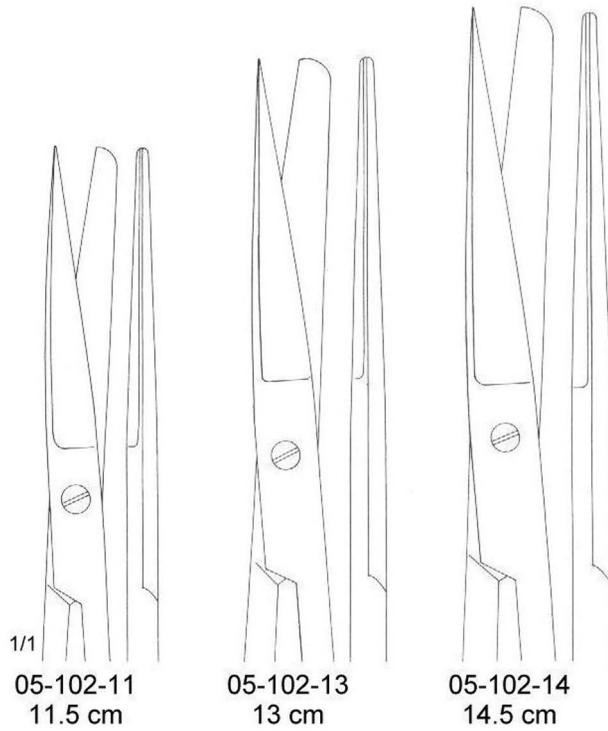


SCISSORS

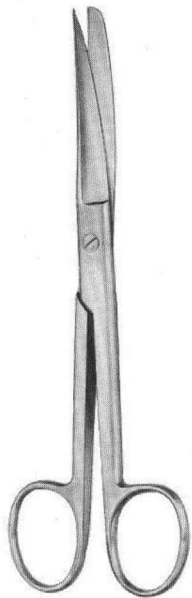


Standard

05-102-10	10.5 cm
05-102-11	11.5 cm
05-102-13	13.0 cm
05-102-14	14.5 cm
05-102-15	15.5 cm
05-102-16	16.5 cm
05-102-18	18.5 cm
05-102-20	20.0 cm

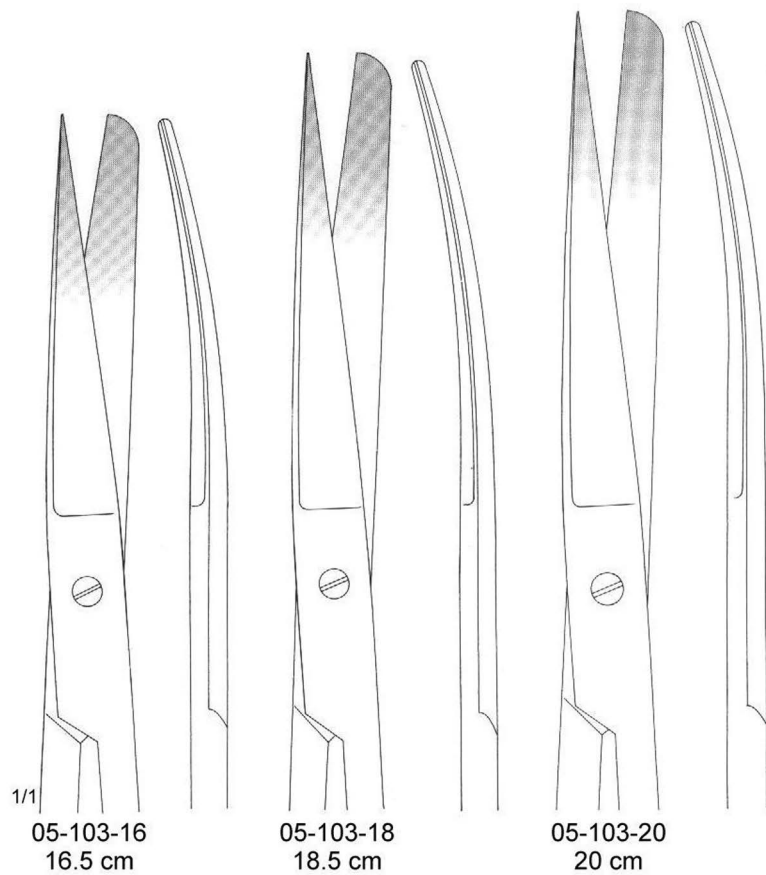
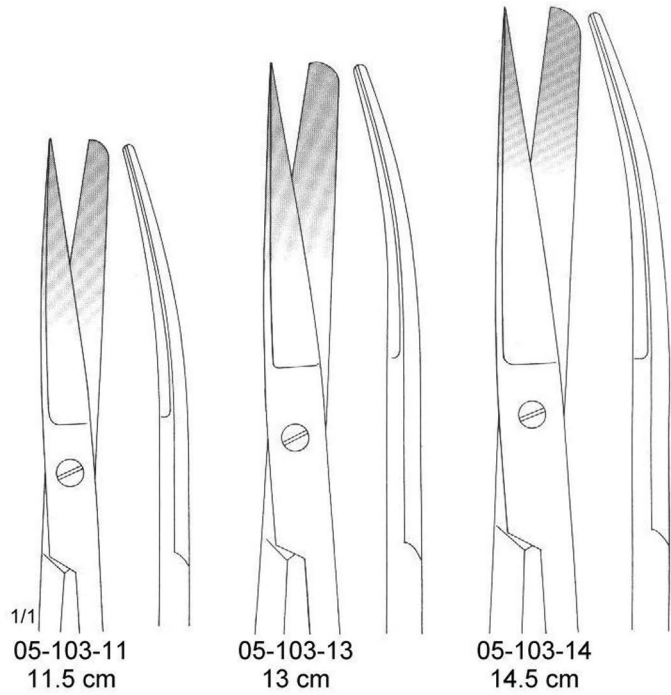


SCISSORS

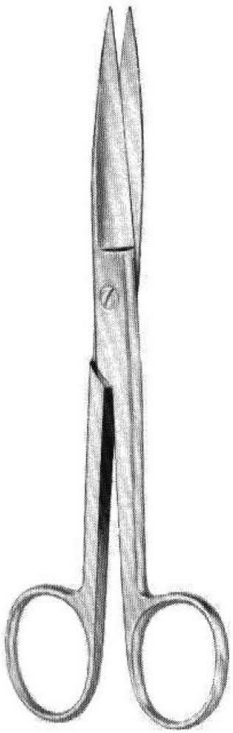


Standard

- 05-103-10 10.5 cm
- 05-103-11 11.5 cm
- 05-103-13 13.0 cm
- 05-103-14 14.5 cm
- 05-103-15 15.5 cm
- 05-103-16 16.5 cm
- 05-103-18 18.5 cm
- 05-103-20 20.0 cm

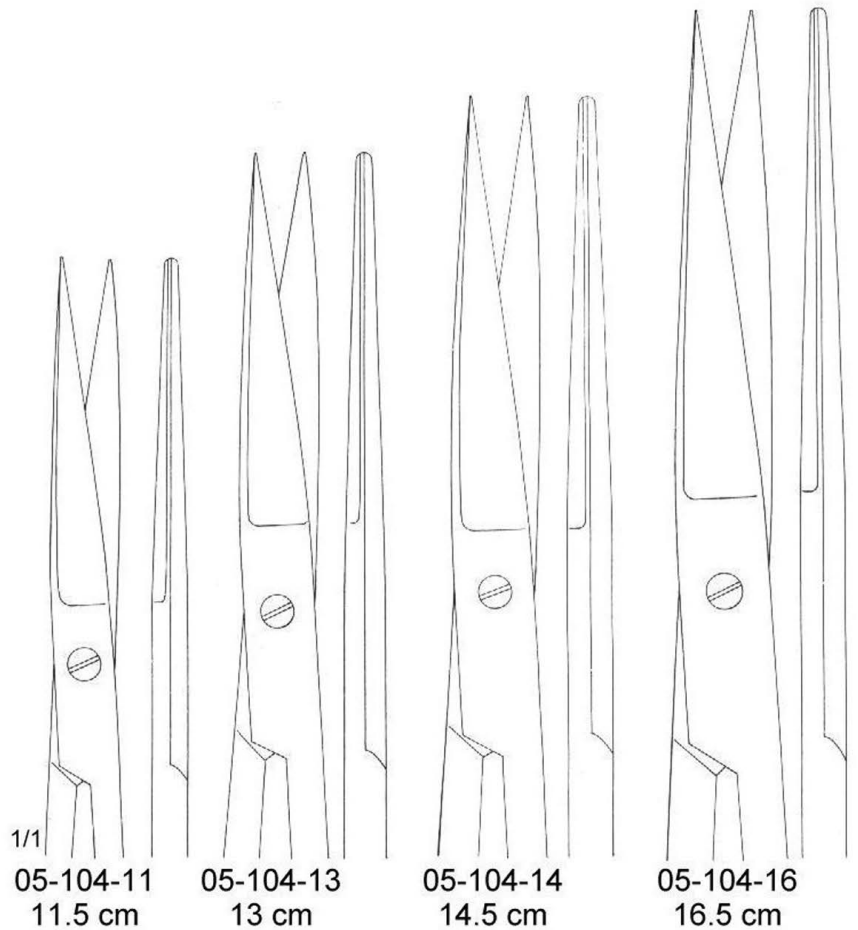


SCISSORS

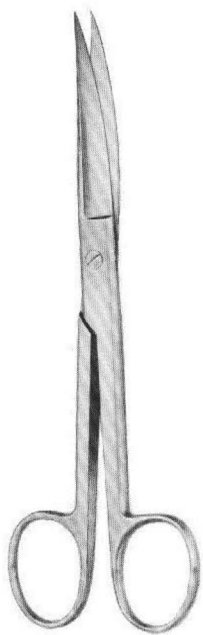


Standard

05-104-10	10.5 cm
05-104-11	11.5 cm
05-104-13	13.0 cm
04-104-14	14.5 cm
04-104-15	15.5 cm
04-104-16	16.5 cm
04-104-18	18.5 cm
04-104-20	20.0 cm

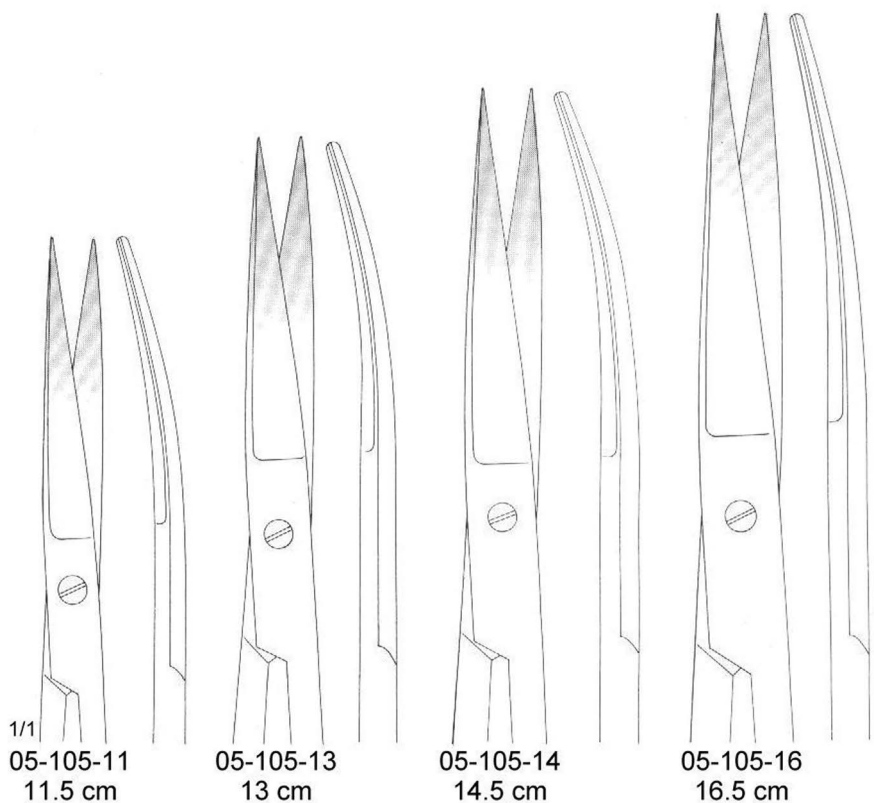


SCISSORS

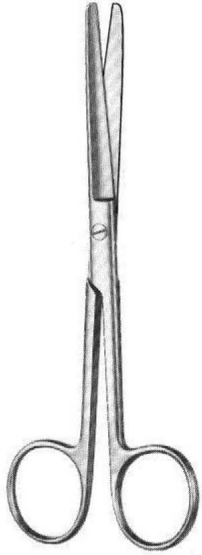


Standard

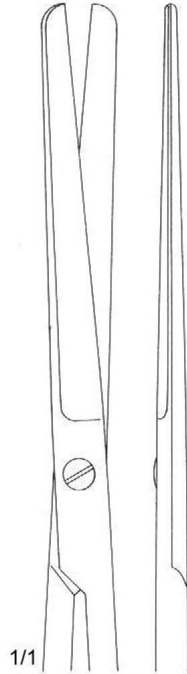
05-105-10	10.5 cm
05-105-11	11.5 cm
05-105-13	13.0 cm
05-105-14	14.5 cm
05-105-15	15.5 cm
05-105-16	16.5 cm
05-105-18	18.5 cm
05-105-20	20.0 cm



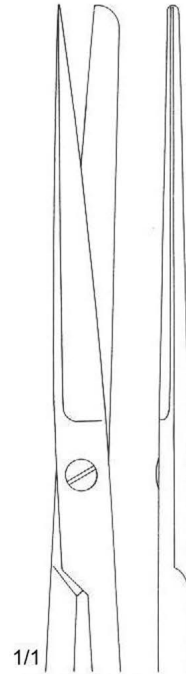
SCISSORS



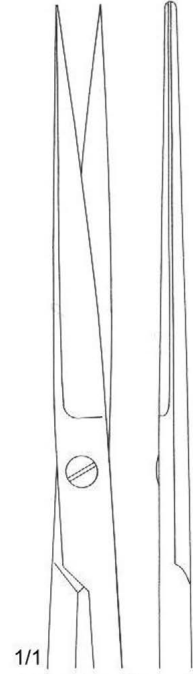
Grazil



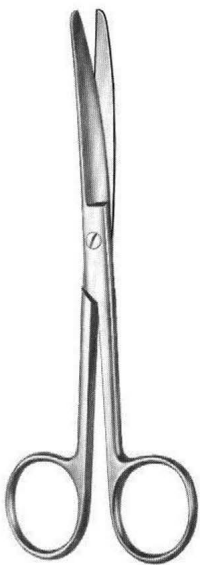
1/1
05-110-14
14.5 cm



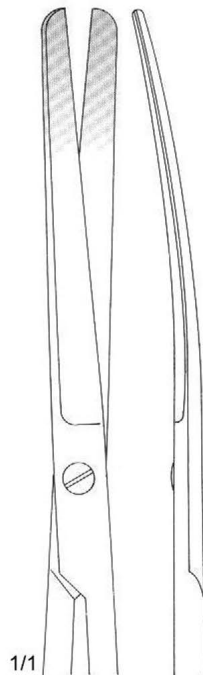
1/1
05-112-14
14.5 cm



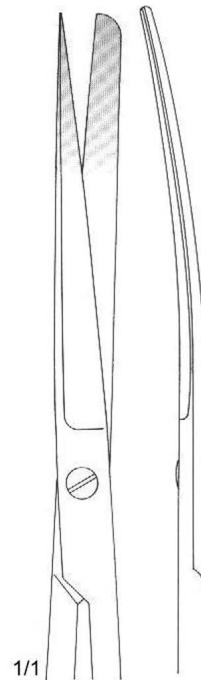
1/1
05-114-14
14.5 cm



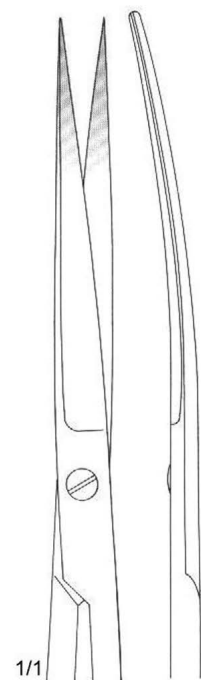
Grazil



1/1
05-111-14
14.5 cm

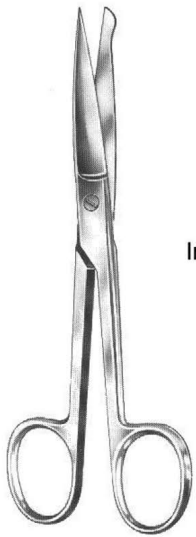


1/1
05-113-14
14.5 cm



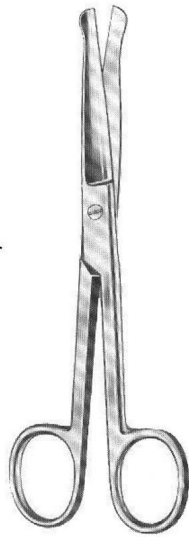
1/1
05-115-14
14.5 cm

SCISSORS

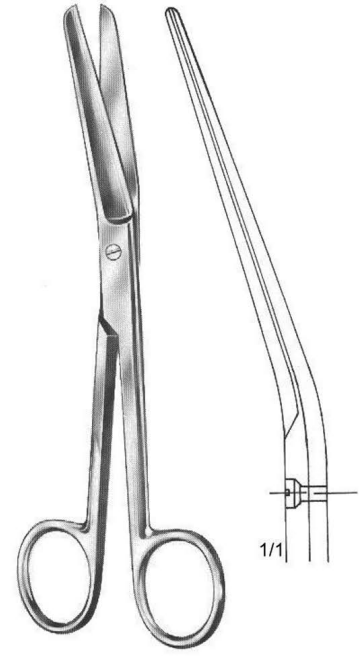


Incision Scissor

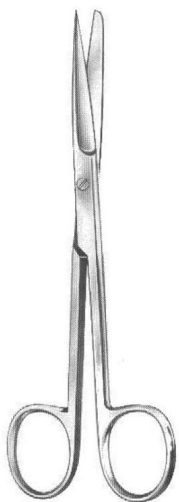
05-120-13 13.0 cm
05-120-14 14.5 cm



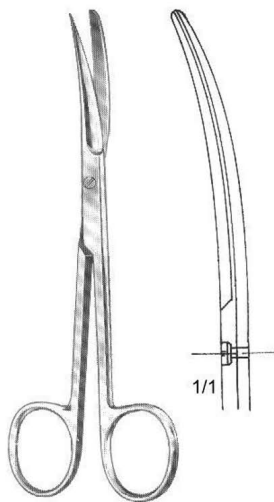
Richter
05-130-14
14.5 cm



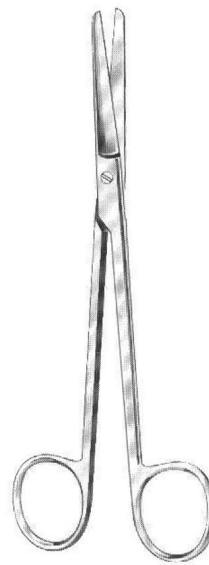
Fergusson
05-140-14 14.0 cm
05-140-16 16.5 cm
05-140-18 18.0 cm



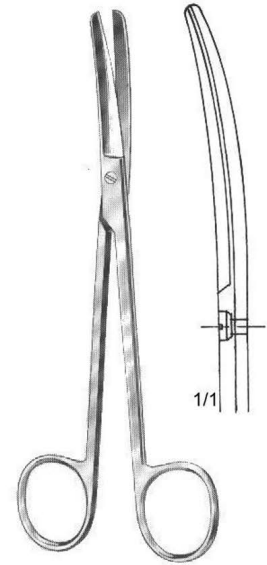
Deaver
05-150-13 13 cm
05-150-14 14 cm



Deaver
05-151-13 13 cm
05-151-14 14 cm

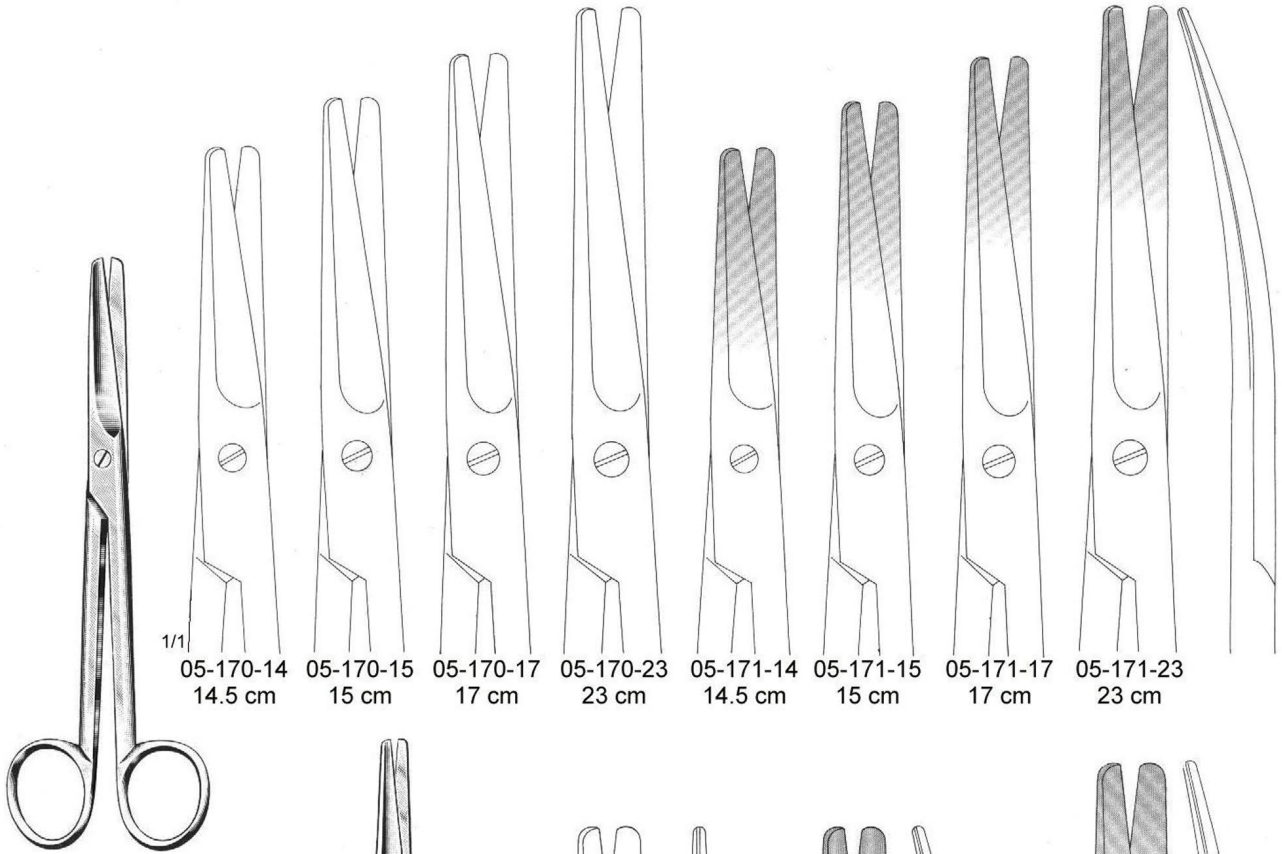


Mixer
05-160-15
15.5 cm



Mixer
05-161-15
15.5 cm

SCISSORS

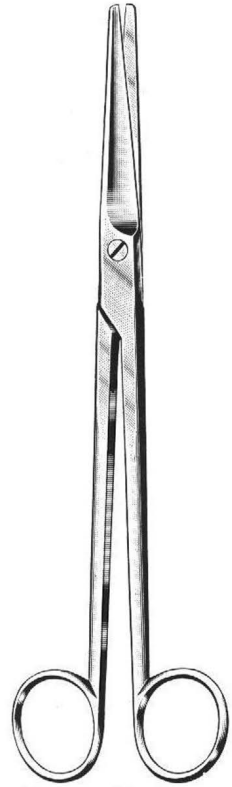


1/1
05-170-14 14.5 cm 05-170-15 15 cm 05-170-17 17 cm 05-170-23 23 cm
05-171-14 14.5 cm 05-171-15 15 cm 05-171-17 17 cm 05-171-23 23 cm



Mayo

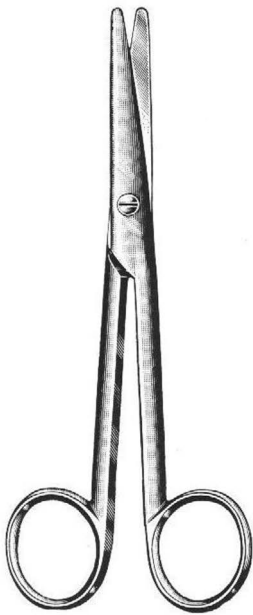
- 05-170-14 14.5 cm
- 05-170-15 15.0 cm
- 05-170-17 17.0 cm
- 05-170-23 23.0 cm
- 05-170-28 28.0 cm
- 05-171-14 14.5 cm
- 05-171-15 15.0 cm
- 05-171-17 17.0 cm
- 05-171-23 23.0 cm
- 05-171-28 28.0 cm



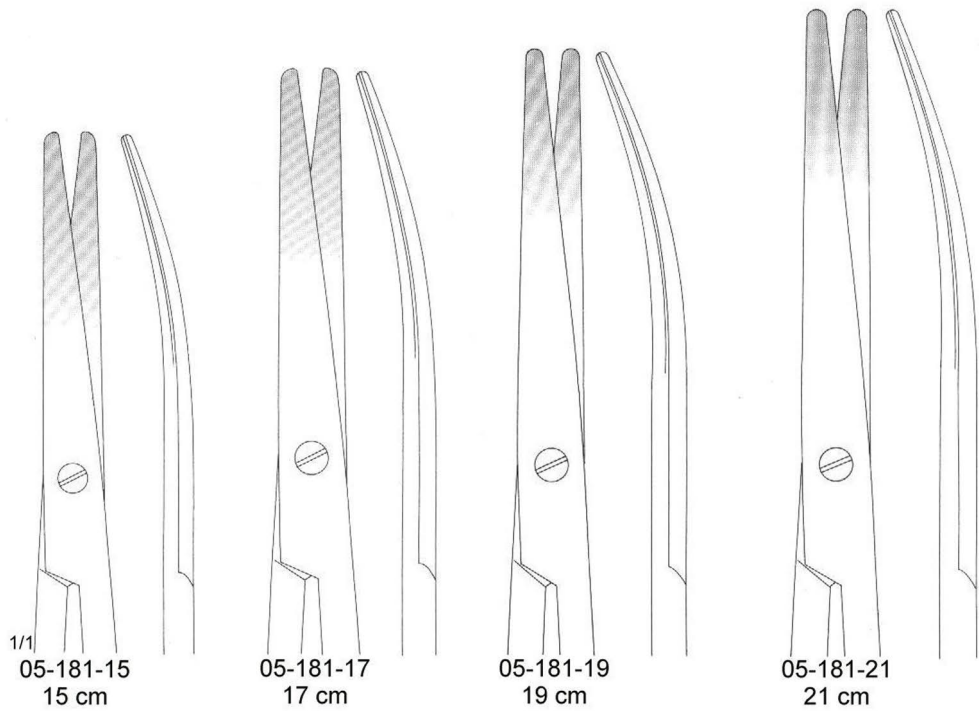
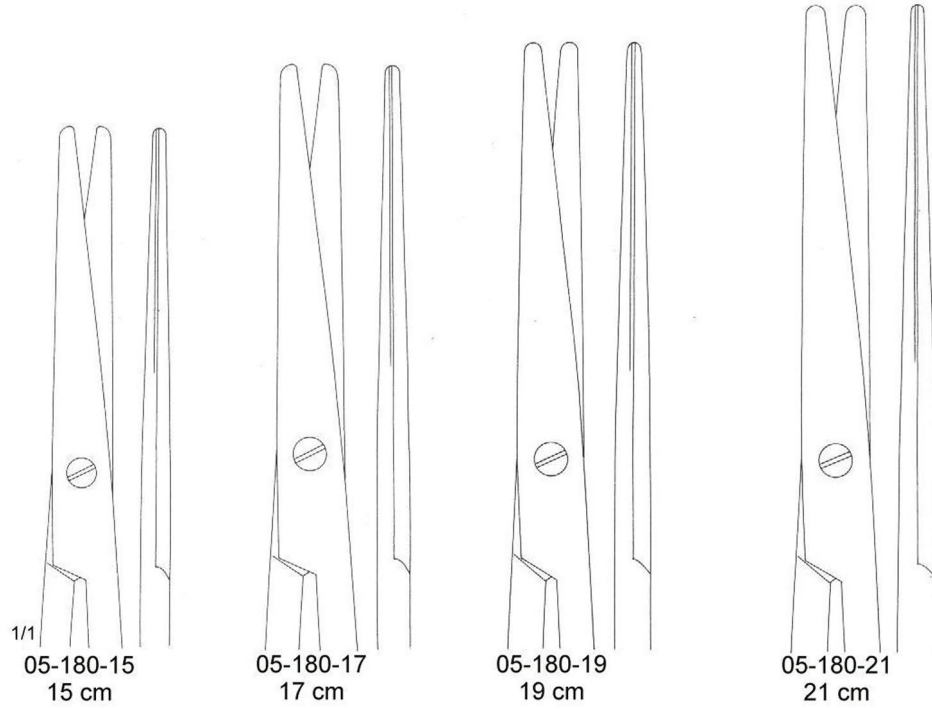
1/1
05-176-22 22.5 cm 05-177-22 22.5 cm 05-177-30 30 cm

- Mayo - Harrington**
- 05-176-22 22.5 cm
 - 05-176-30 30.0 cm
 - 05-177-22 22.5 cm
 - 05-177-30 30.0 cm

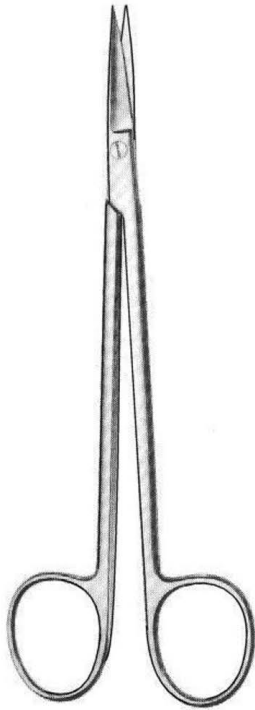
SCISSORS



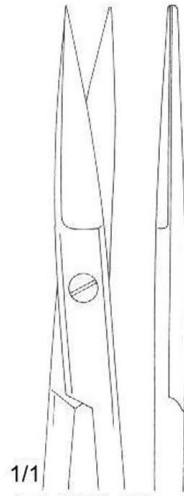
Mayo - Stille



SCISSORS

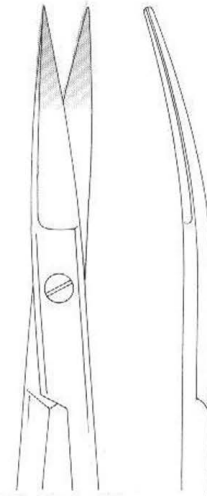


Kelly
05-190-16 - 05-191-18



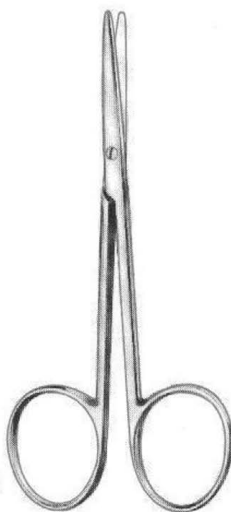
1/1
05-190-16
16 cm

05-190-18
18 cm

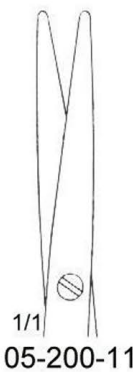


05-191-16
16 cm

05-191-18
18 cm



1/2
Metzenbaum - Baby
05-200-11 - 05-201-11
11.5 cm

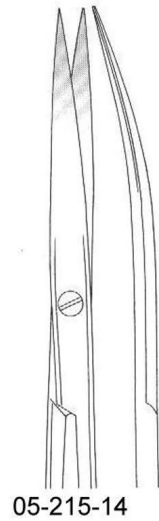
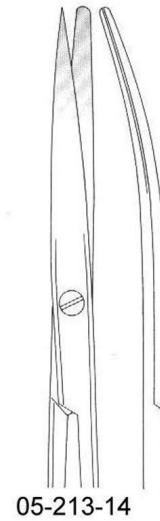
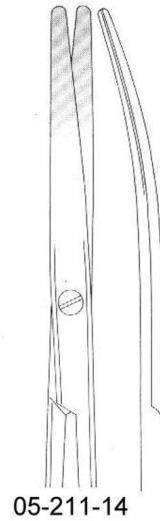
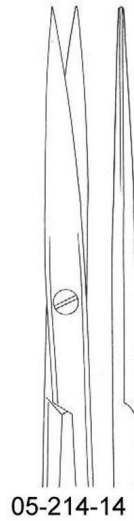
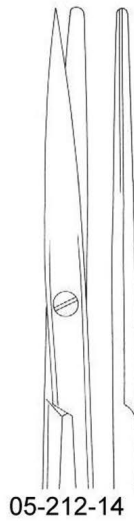
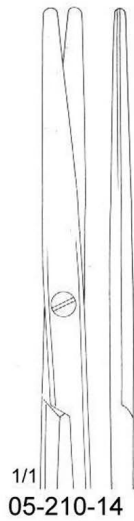
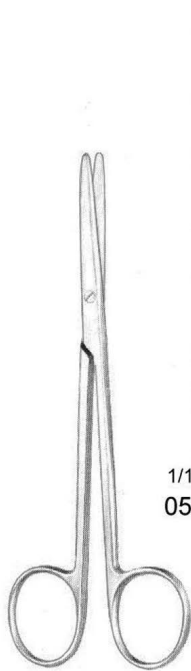


1/1
05-200-11

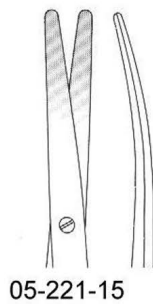
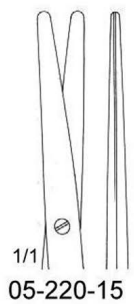
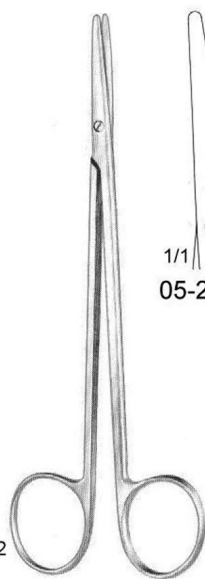


05-201-11

SCISSORS

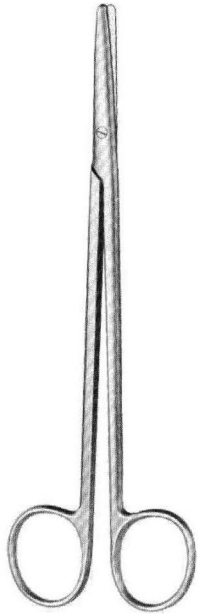


Metzenbaum
05-210-14 - 05-215-14
14.5 cm

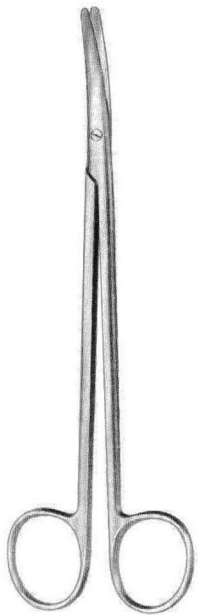
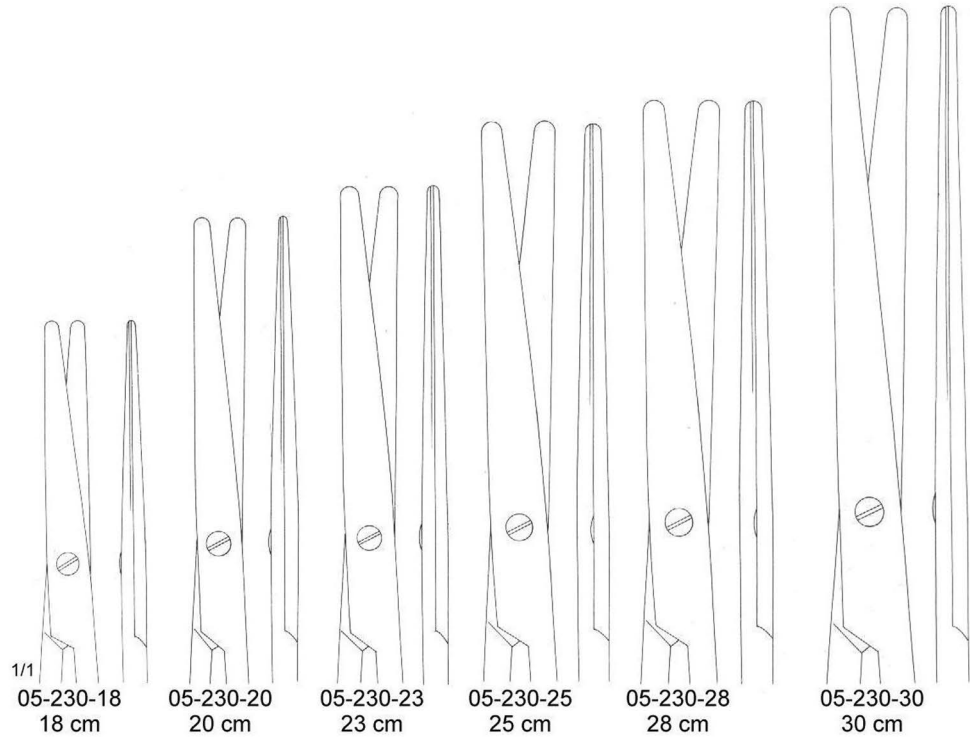


1/2
Metzenbaum
05-220-15 - 05-221-15
15 cm

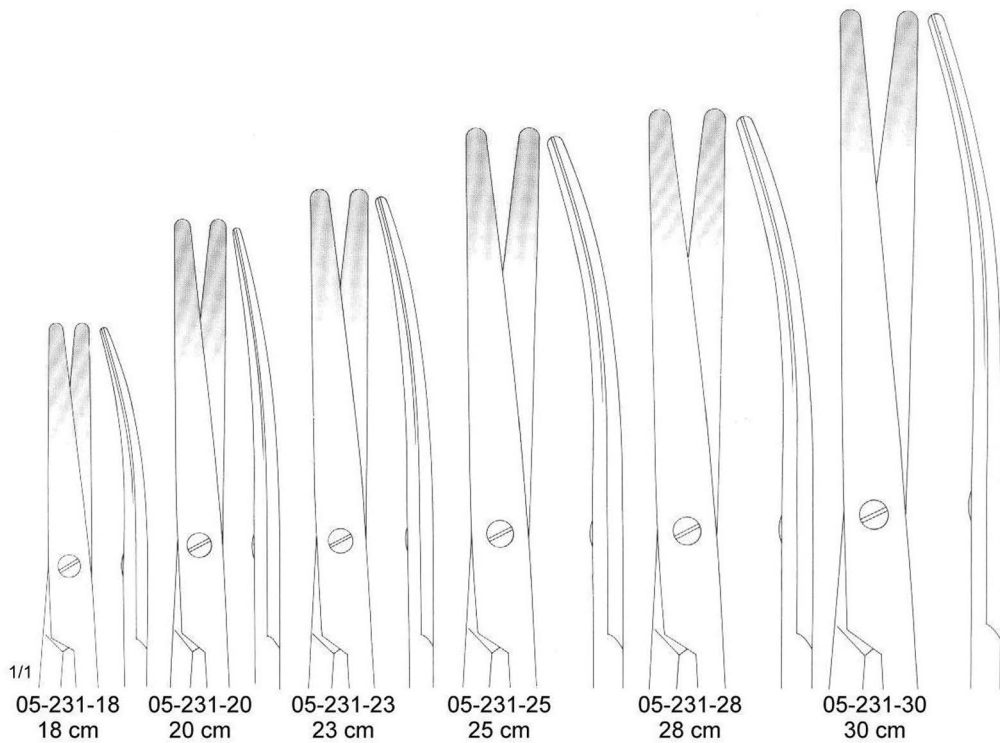
SCISSORS



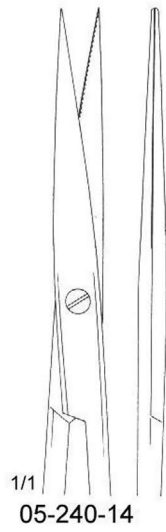
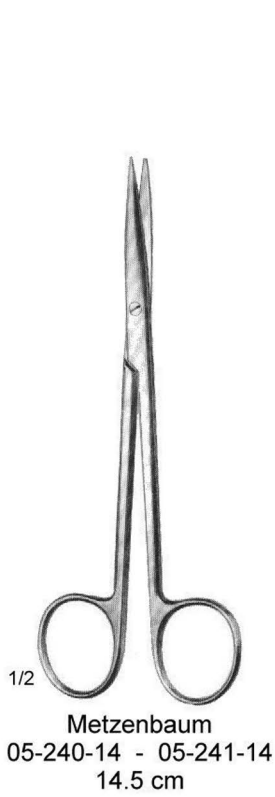
Metzenbaum - Nelson
05-230-18 - 05-230-30



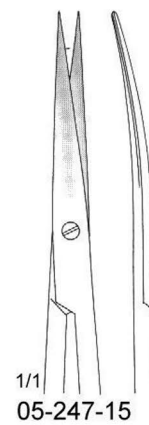
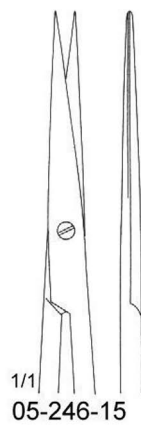
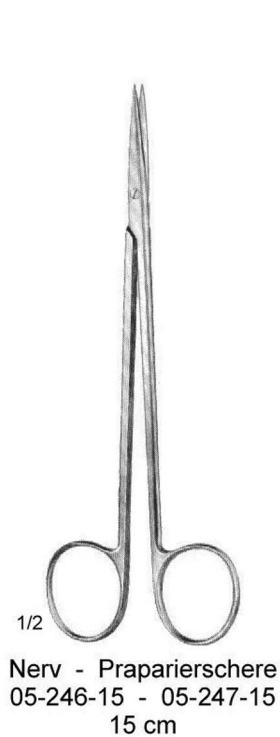
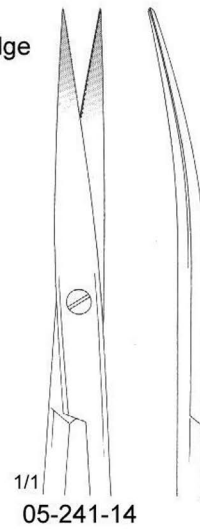
Metzenbaum - Nelson
05-231-18 - 05-231-30



SCISSORS

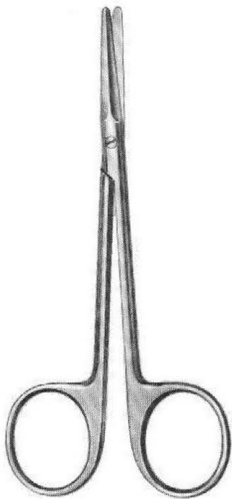


saw edge



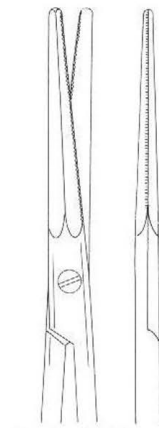
blades outside semi-sharp

SCISSORS

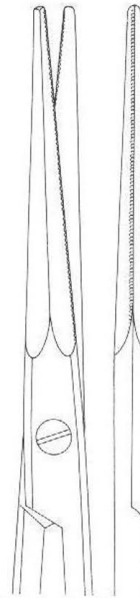


Gorney

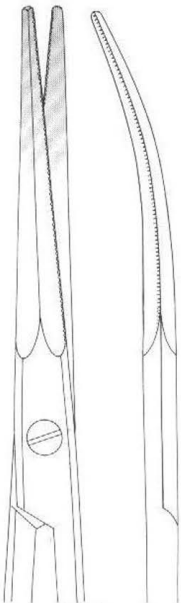
05-250-12 12.5 cm
05-250-19 19.5 cm
05-251-12 12.5 cm
05-251-19 19.5 cm



05-250-12
12.5 cm



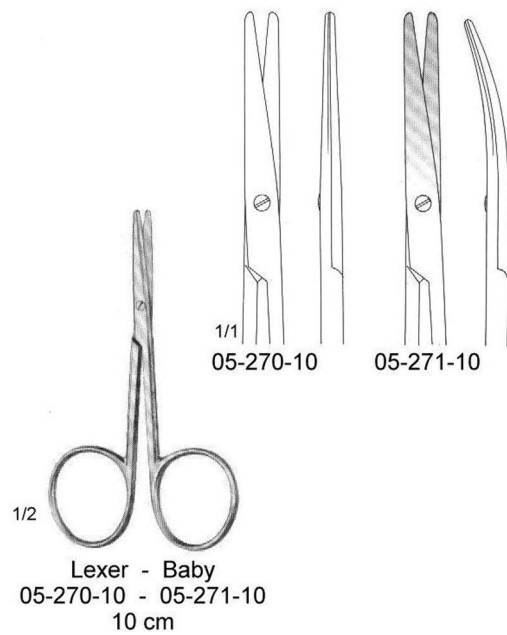
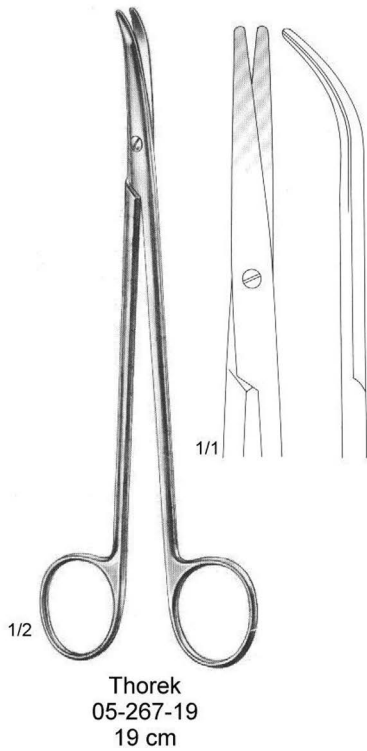
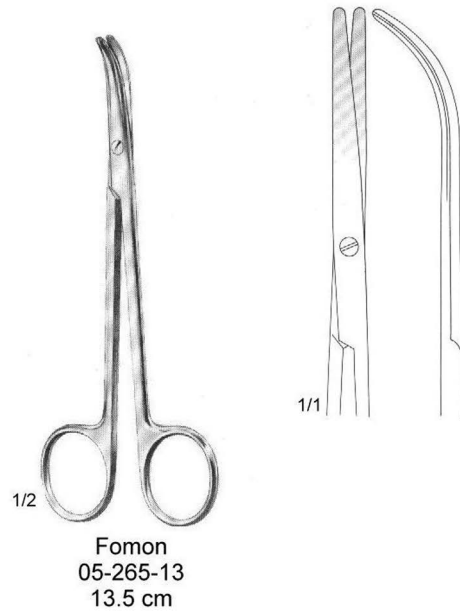
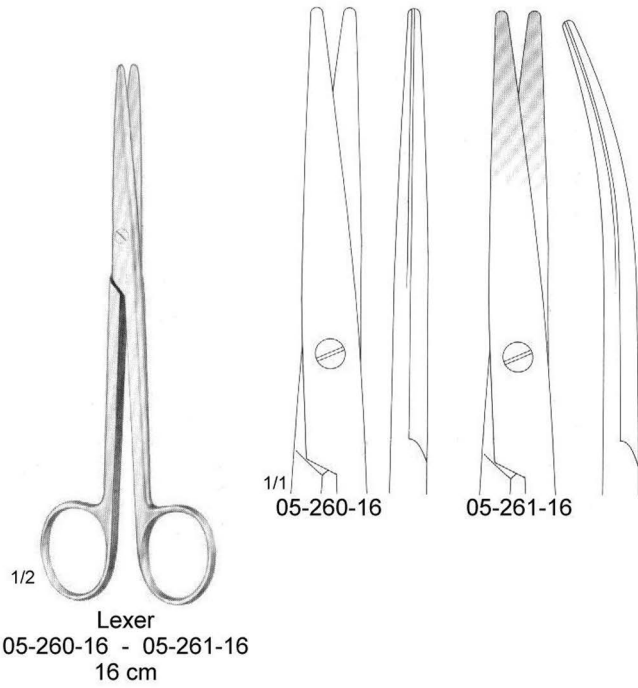
05-250-19
19.5 cm



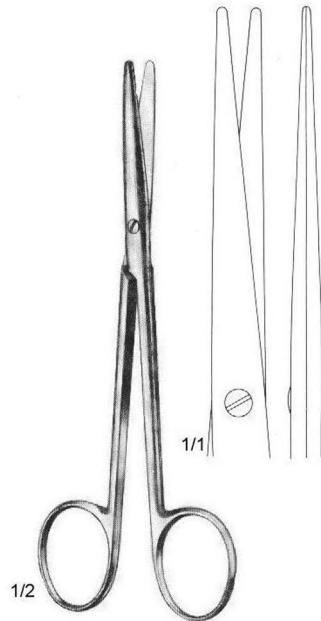
05-251-19
19.5 cm

blades outside semi-sharp and inside serrated

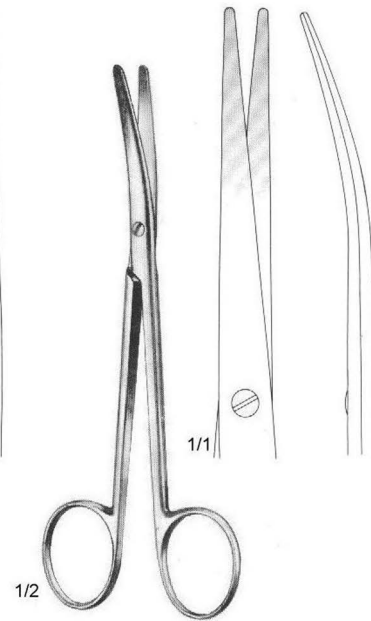
SCISSORS



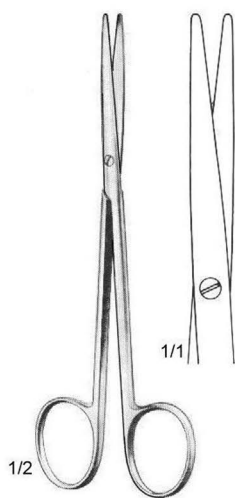
SCISSORS



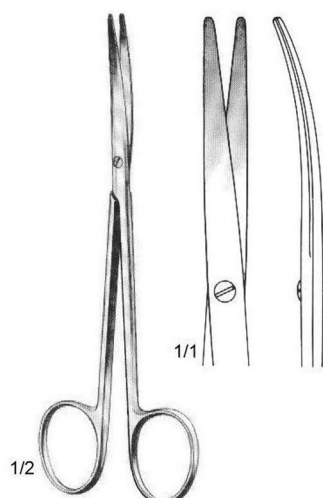
Lexer - Fine
05-280-16
16 cm



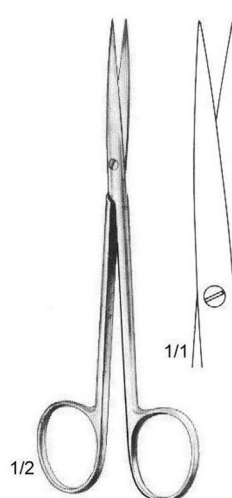
Lexer - Fine
05-281-16
16 cm



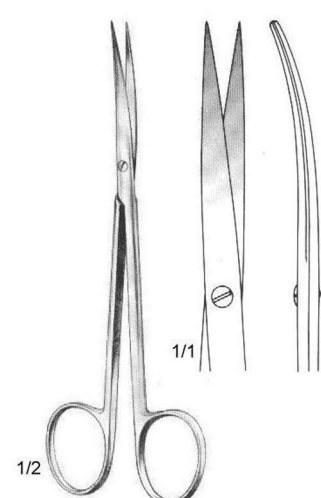
Metzenbaum - Fine
05-286-14
14.5 cm



Metzenbaum - Fine
05-287-14
14.5 cm

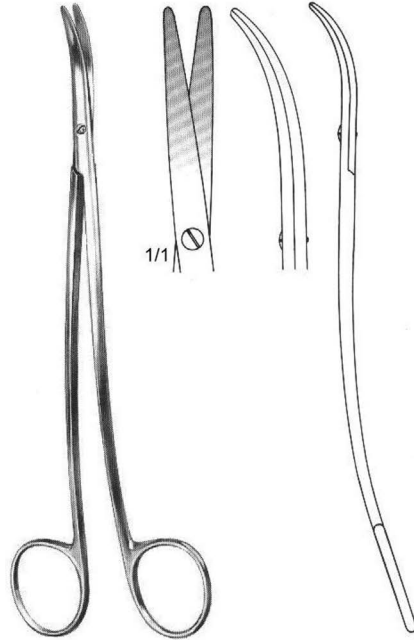


Metzenbaum - Fine
05-288-14
14.5 cm

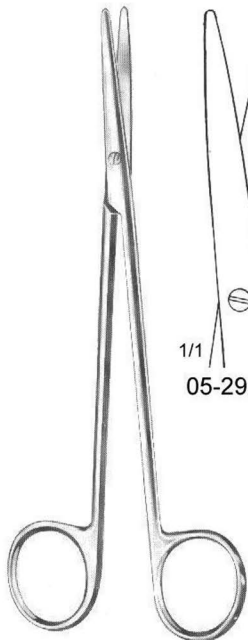


Metzenbaum - Fine
05-289-14
14.5 cm

SCISSORS

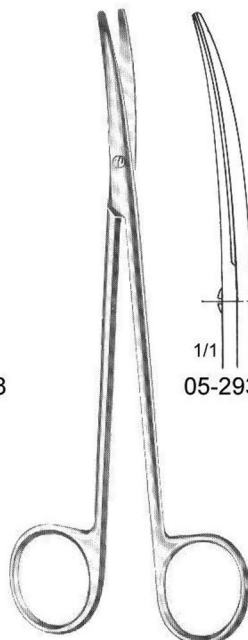


S - shaped Metzenbaum - Fine
05-290-18 18 cm
05-290-20 20 cm
05-290-23 23 cm



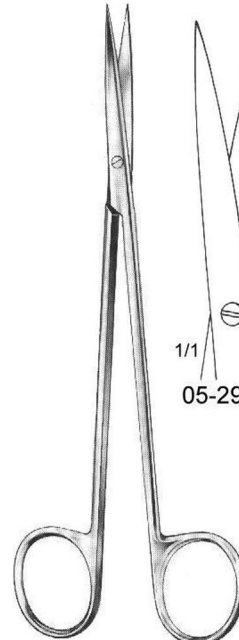
1/1
05-292-18

Metzenbaum - Fine
05-292-18 18 cm
05-292-20 20 cm
05-292-23 23 cm
05-292-25 25 cm
05-292-28 28 cm
05-292-30 30 cm



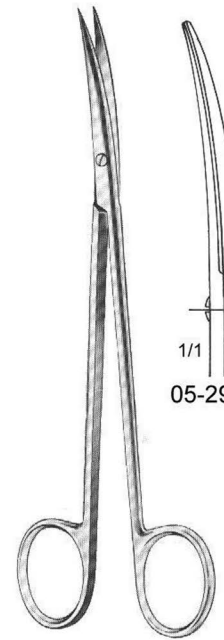
1/1
05-293-18

Metzenbaum - Fine
05-293-18 18 cm
05-293-20 20 cm
05-293-23 23 cm
05-293-25 25 cm
05-293-28 28 cm
05-293-30 30 cm



1/1
05-294-18

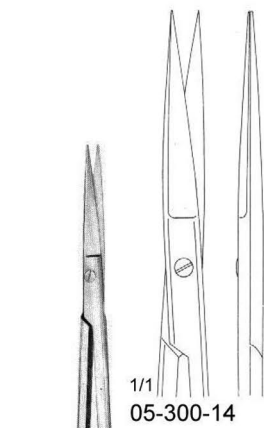
Metzenbaum - Fine
05-294-18 18 cm
05-294-20 20 cm
05-294-23 23 cm
05-294-25 25 cm
05-294-28 28 cm
05-294-30 30 cm



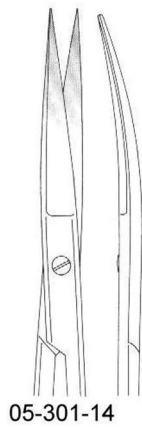
1/1
05-295-18

Metzenbaum - Fine
05-295-18 18 cm
05-295-20 20 cm
05-295-23 23 cm
05-295-25 25 cm
05-295-28 28 cm
05-295-30 30 cm

SCISSORS

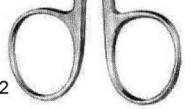


1/1
05-300-14

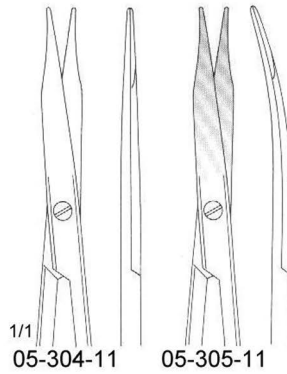


05-301-14

1/2



Sanvenero
05-300-14 - 05-301-14
14 cm



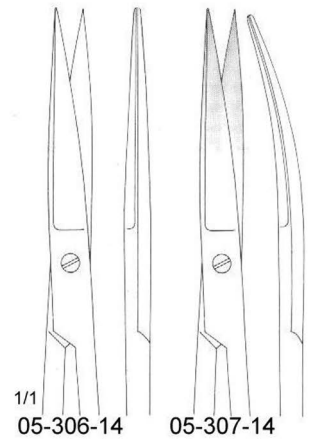
1/1
05-304-11

05-305-11

1/2



05-304-11 - 05-305-11
11 cm



1/1
05-306-14

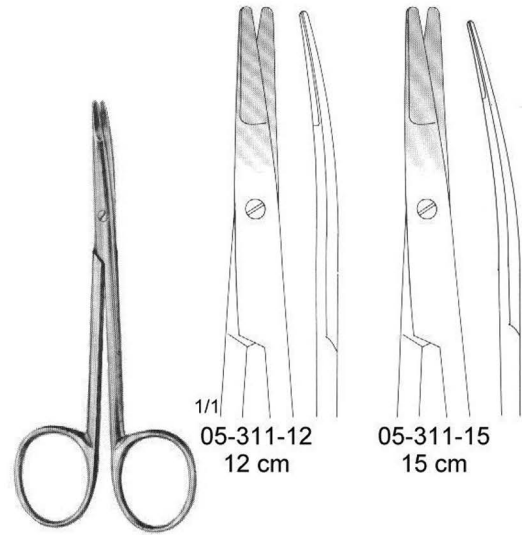
05-307-14

1/2

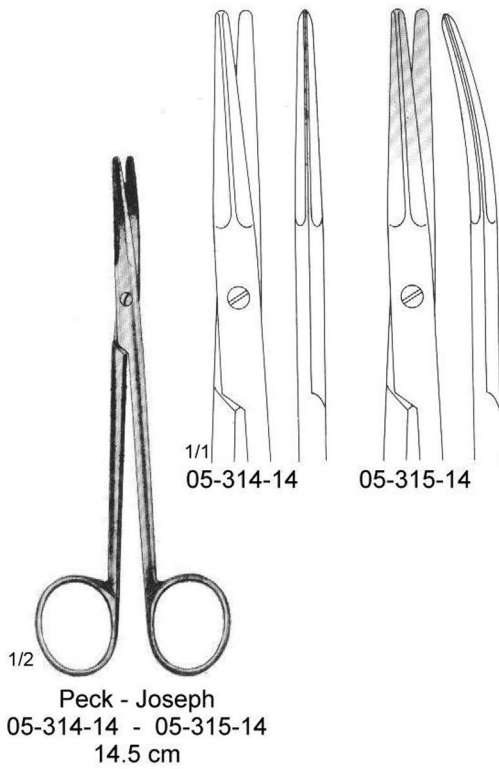


Joseph
05-306-14 - 05-307-14
14 cm

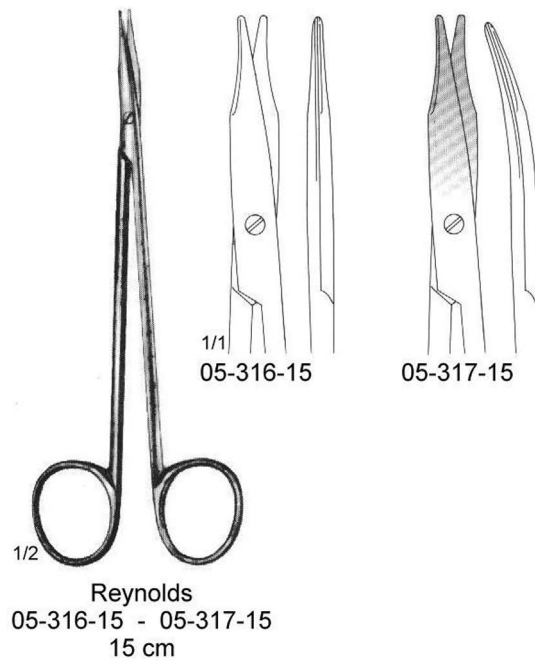
SCISSORS



Kilner
05-311-12 - 05-311-15

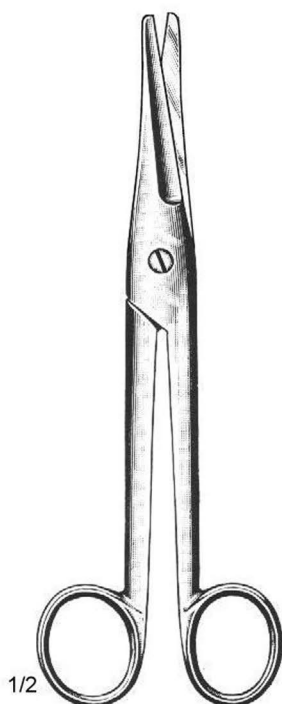


Peck - Joseph
05-314-14 - 05-315-14
14.5 cm

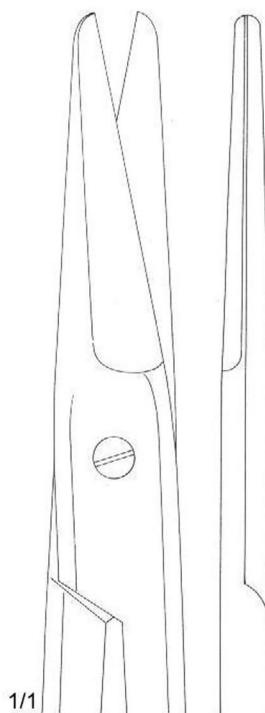


Reynolds
05-316-15 - 05-317-15
15 cm

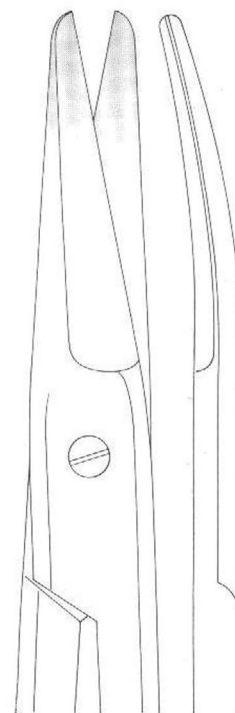
SCISSORS



Mayo - Noble
05-320-15 15 cm
05-320-17 17 cm
05-321-15 15 cm
05-321-17 17 cm

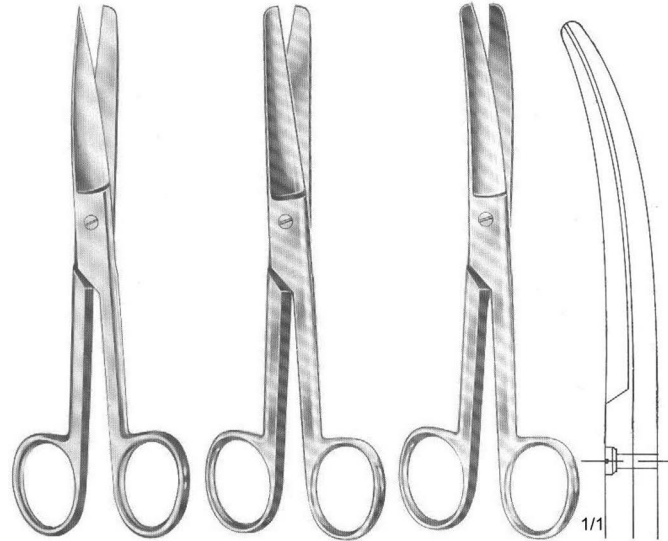


05-320-17



05-321-17

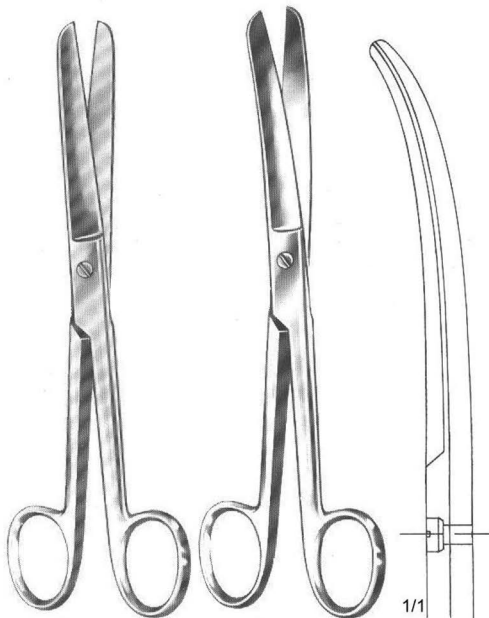
SCISSORS



Doyen
05-330-16
16 cm

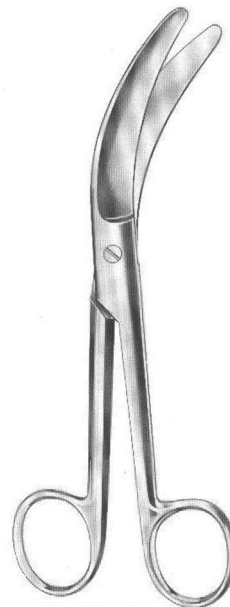
Doyen
05-332-16
16 cm

Doyen
05-333-16
16 cm

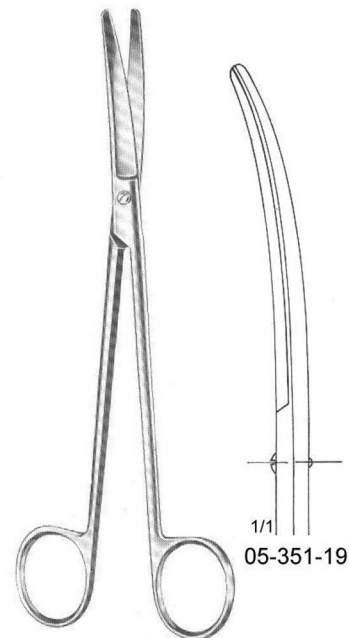


Doyen
05-340-17
17.5 cm

Doyen
05-341-17
17.5 cm

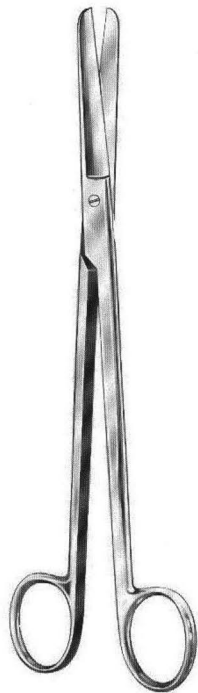


Vezien
05-348-18
18 cm



Wertheim
05-351-14 14.5 cm
05-351-19 19.5 cm
05-351-22 22.5 cm

SCISSORS



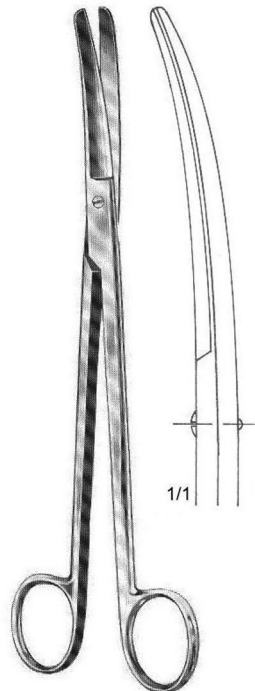
Sims
05-360-20 20 cm
05-360-23 23 cm



05-362-20
05-362-23



05-364-20
05-364-23



Sims
05-361-20 20 cm
05-361-23 23 cm

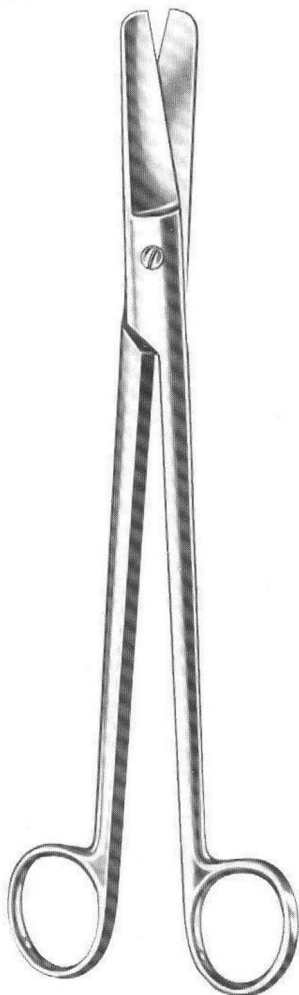


05-363-20
05-363-23

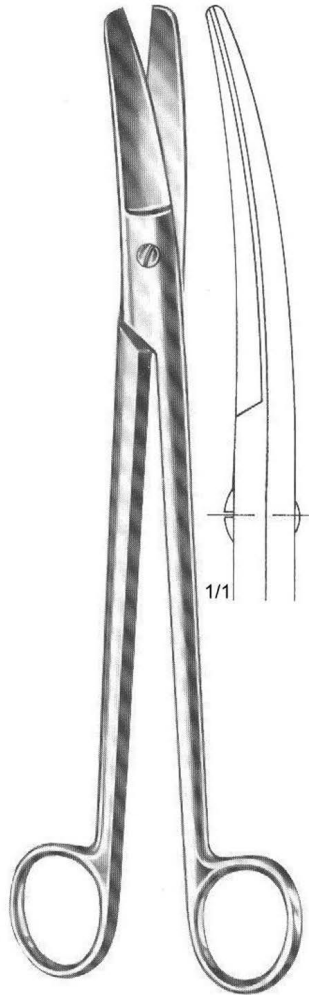


05-365-20
05-365-23

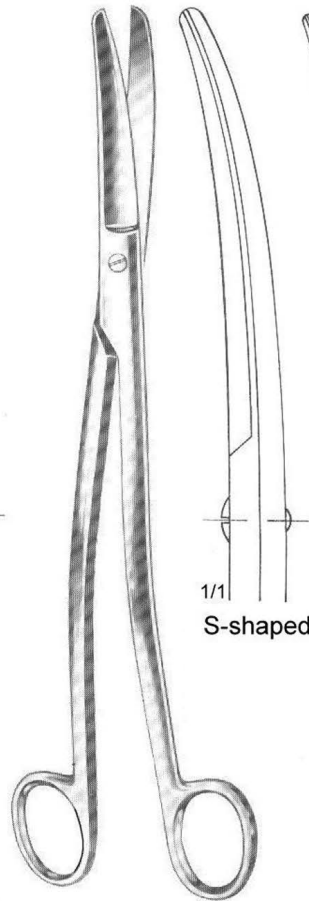
SCISSORS



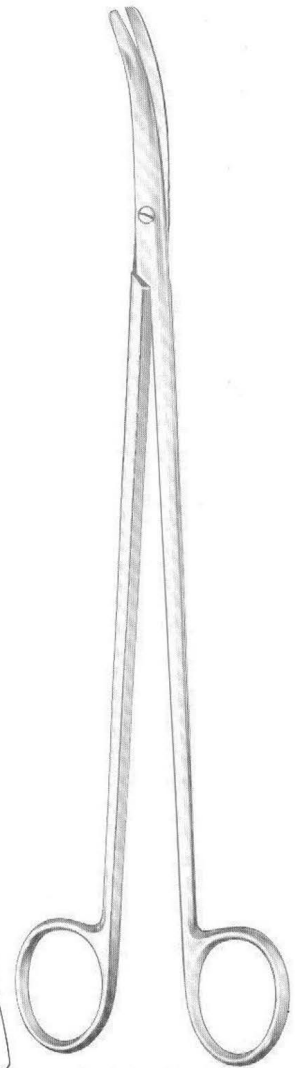
Dubois
05-370-27
27 cm



Dubois
05-371-27
27 cm

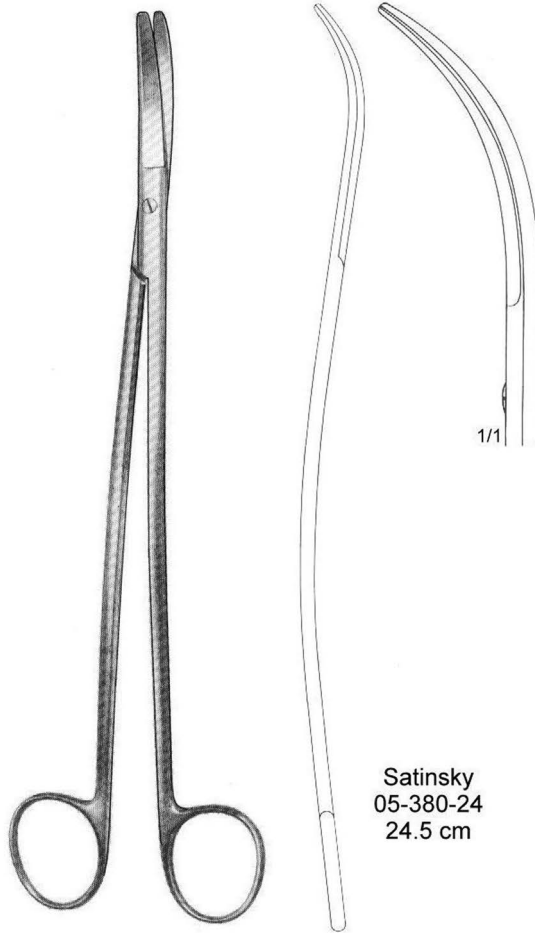


Sims - Siebold
05-375-24
24 cm

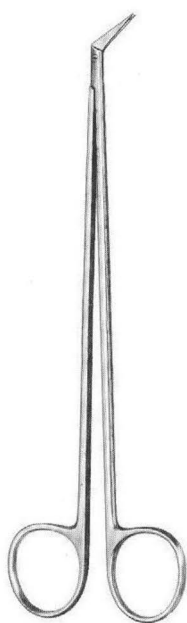


Cardinale
05-379-28
28 cm

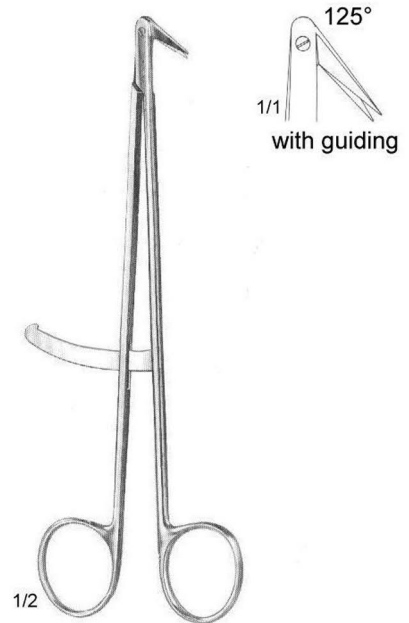
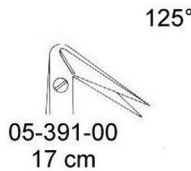
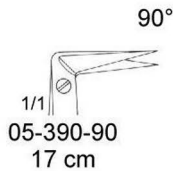
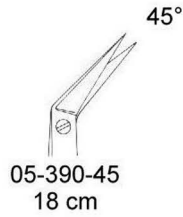
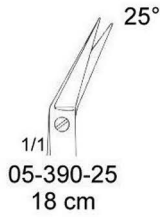
SCISSORS



Satinsky
05-380-24
24.5 cm

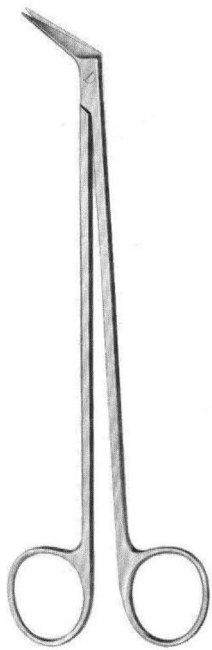
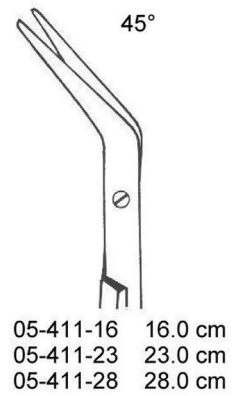
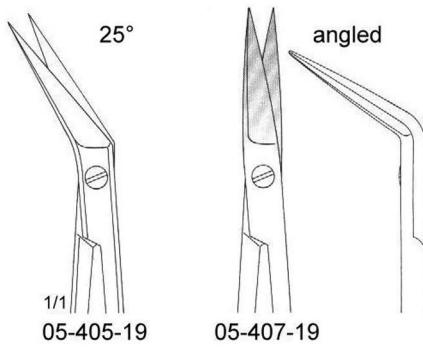
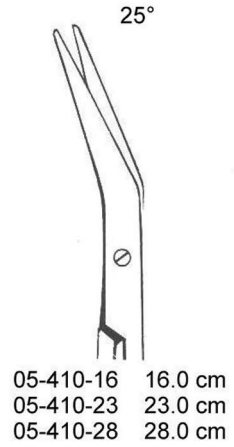
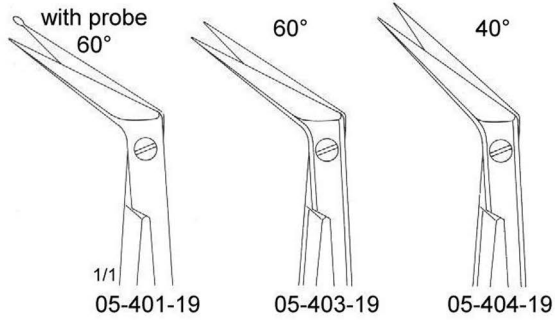


Dietrich
05-390-25 - 05-391-00

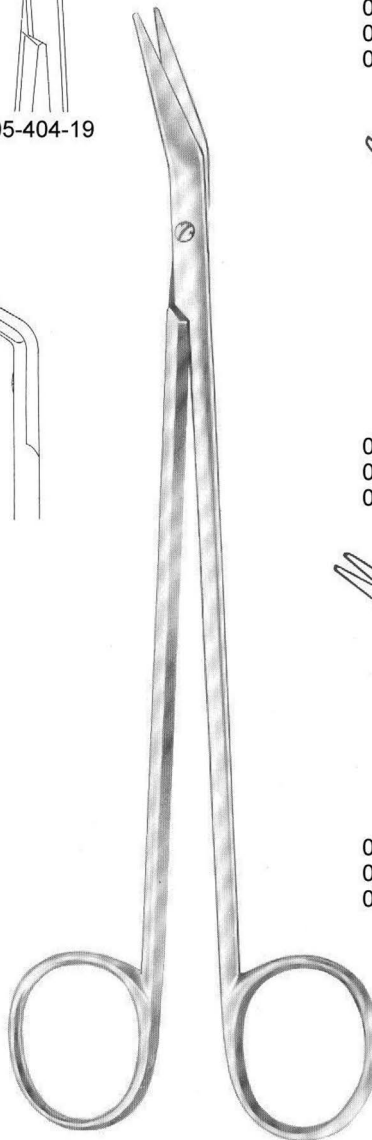


Dietrich
05-391-01
17 cm

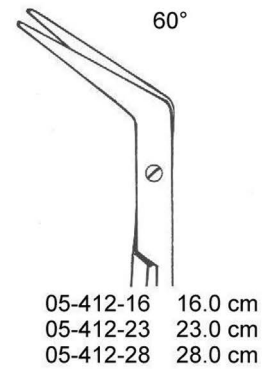
SCISSORS



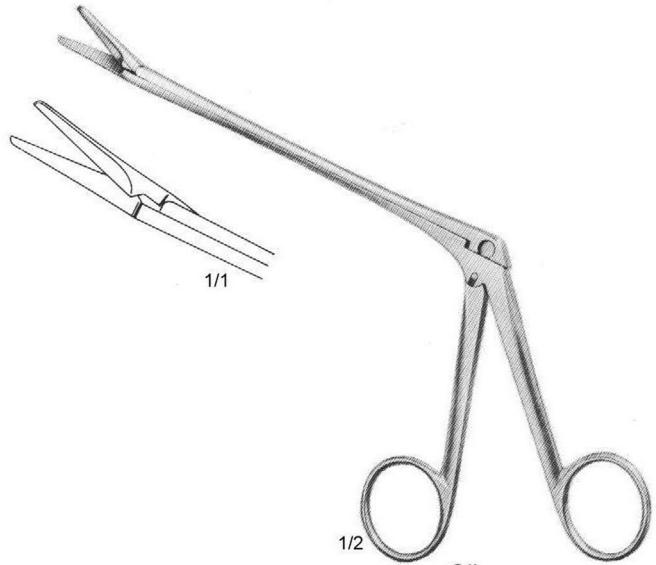
Potts - Smith
05-401-19 - 05-407-19
19 cm



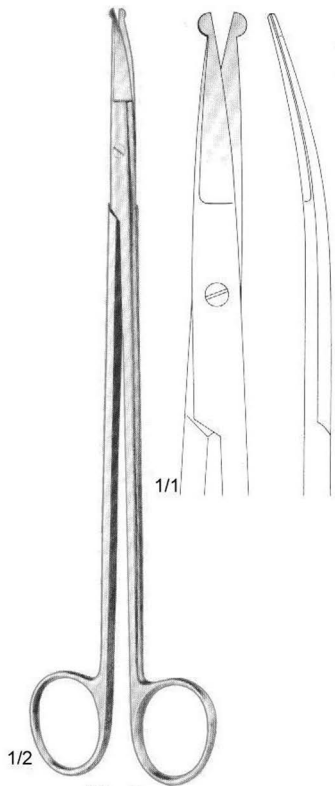
De Bakey



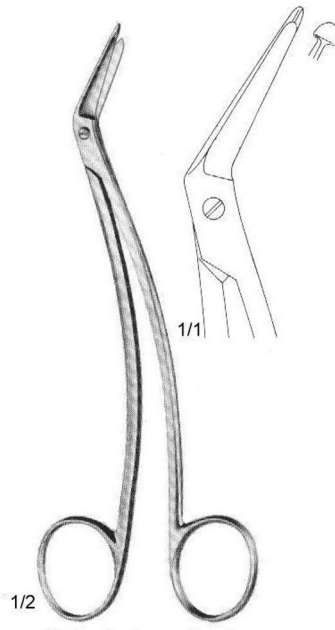
SCISSORS



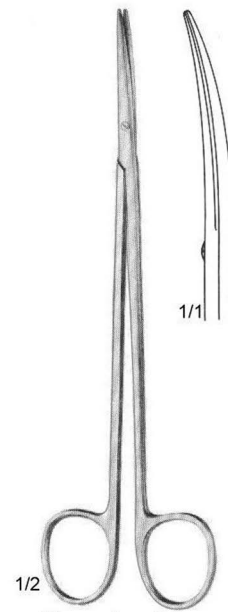
Olivecrona
05-421-23
23 cm



Strully
05-423-22
22 cm



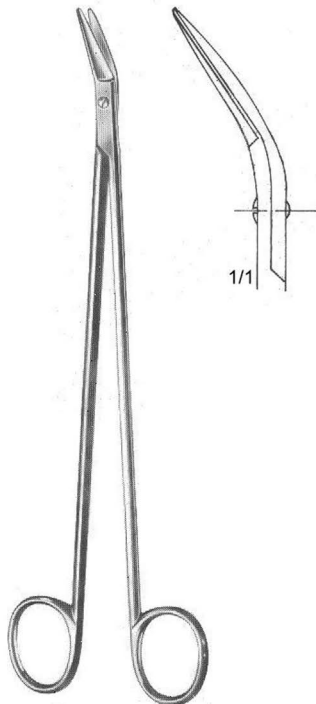
Schmieden - Taylor
05-425-17
17 cm



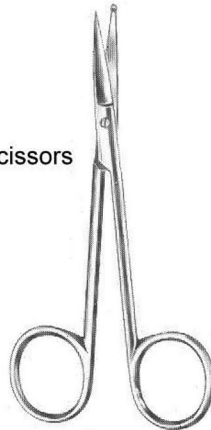
Toennis - Adson
05-427-17
17.5 cm

SCISSORS

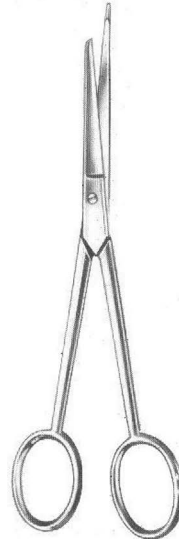
Coronary - Scissors



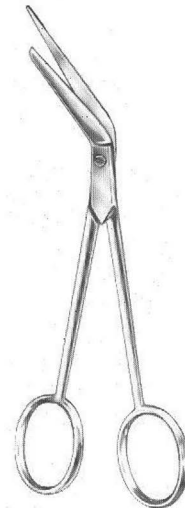
Potts - Smith
05-431-19
19.5 cm



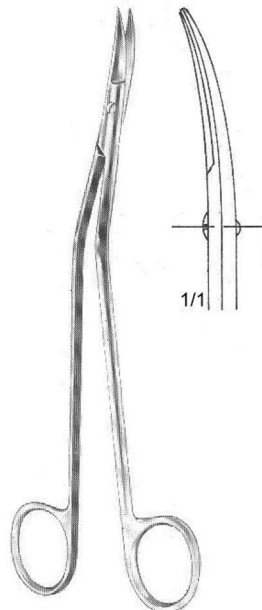
05-432-11
11.5 cm



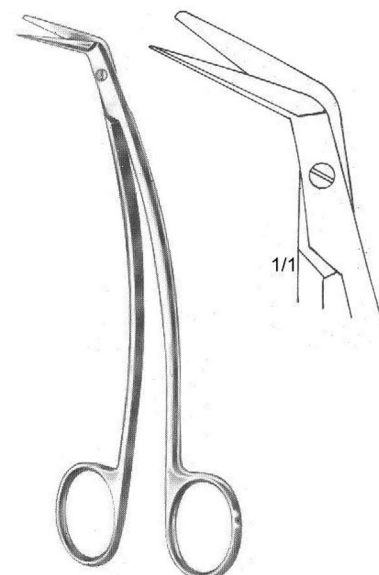
05-434-14
14.5 cm



05-435-14
14.5 cm

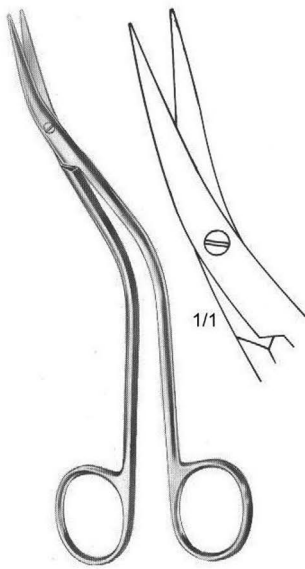


Dandy
05-437-17
17 cm

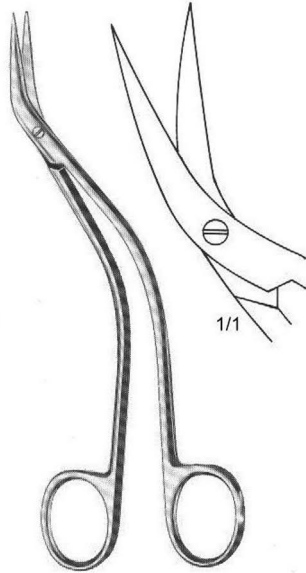


Favaloro
05-439-15
15 cm

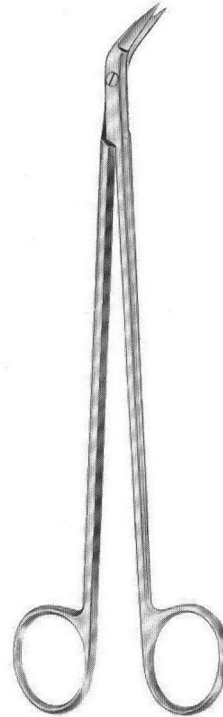
SCISSORS



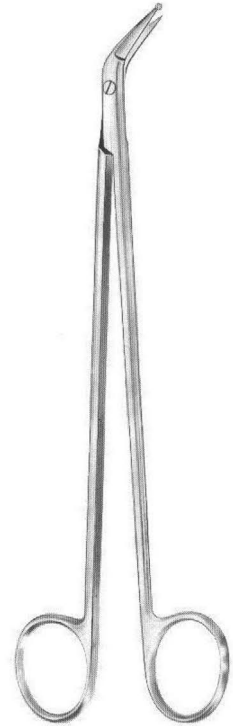
De Bakey
05-440-15
15.5 cm



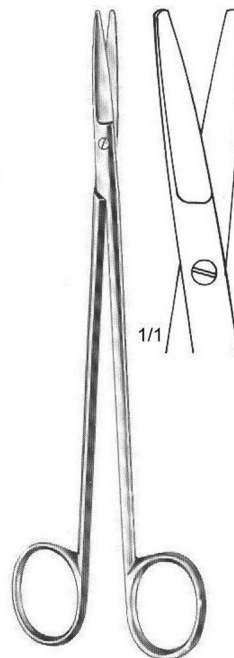
De Bakey
05-441-15
15.5 cm



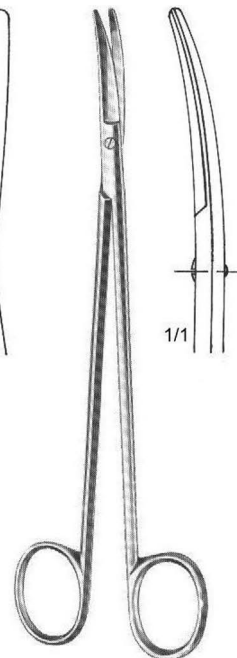
Potts - De Martel
05-442-21
21 cm



Mills
05-444-21
21 cm

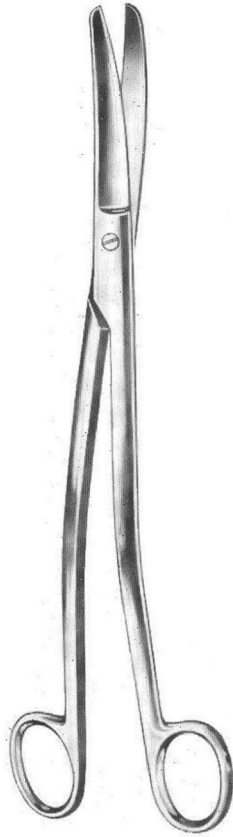


Toennis
05-446-18
18 cm

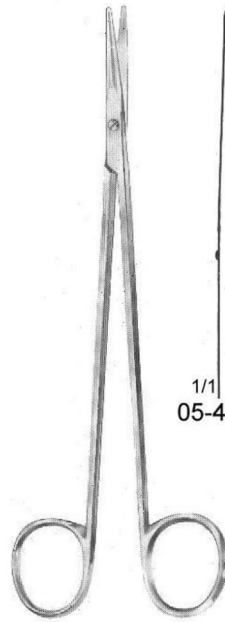


Toennis
05-447-18
18 cm

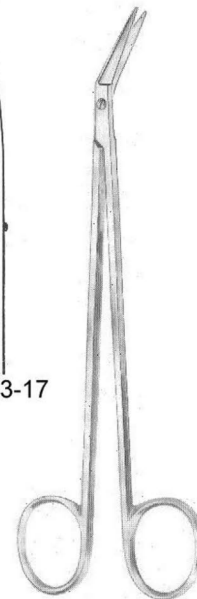
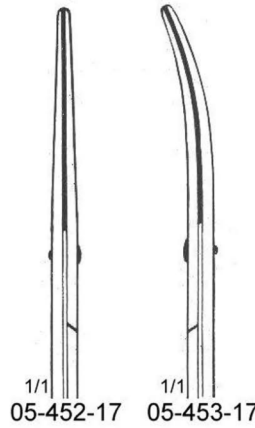
SCISSORS



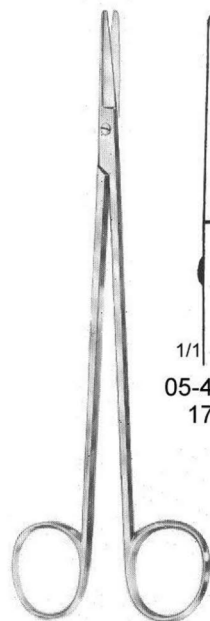
Klinkenbergh - Loth
05-450-23
23 cm



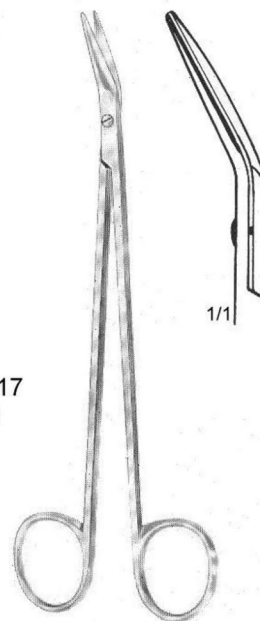
Lincoln
05-452-17 - 05-453-17
17 cm



Fulton
05-454-17
17 cm



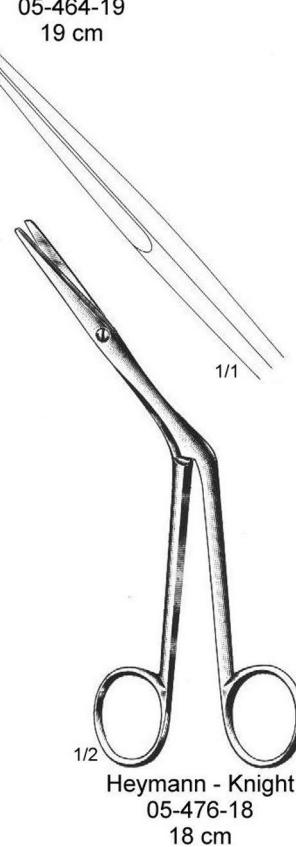
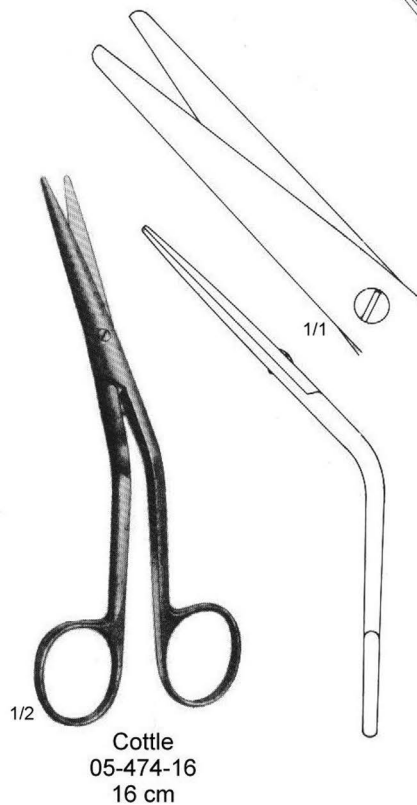
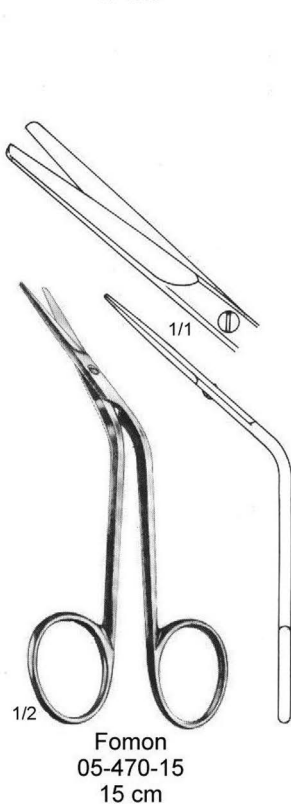
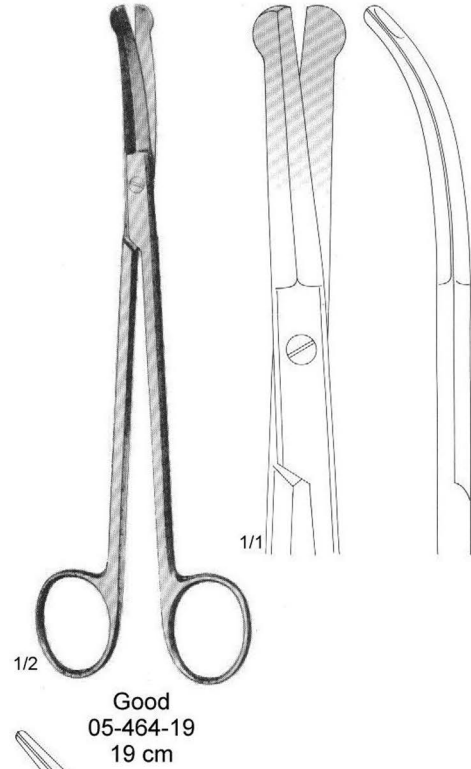
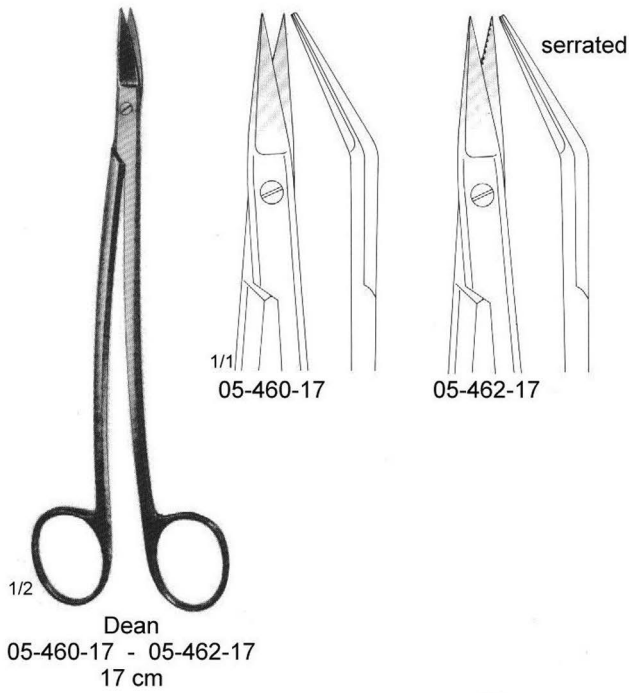
Church



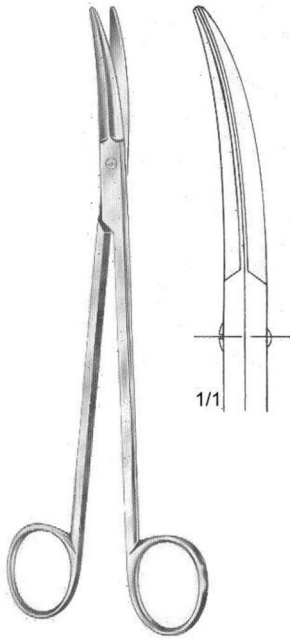
Classon
05-458-17
17 cm



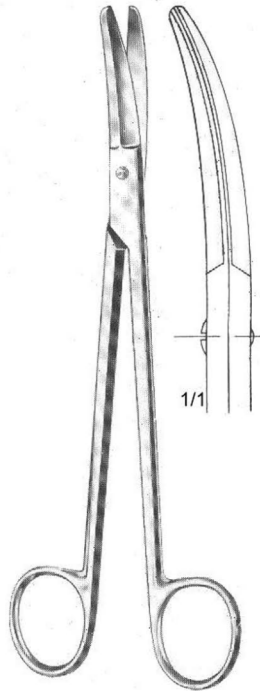
SCISSORS



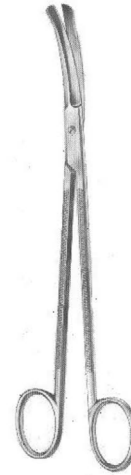
SCISSORS



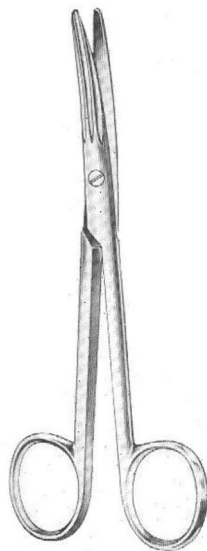
Prince
05-481-17
17.5 cm



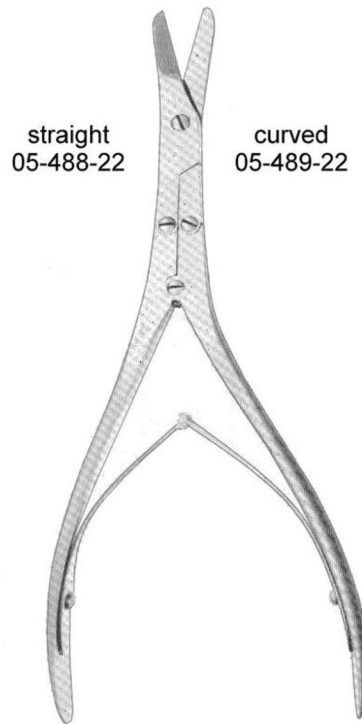
Bottcher
05-483-18
18 cm



Good - Schweckendick
05-485-19
19 cm



Schoemaker
05-487-15
15 cm

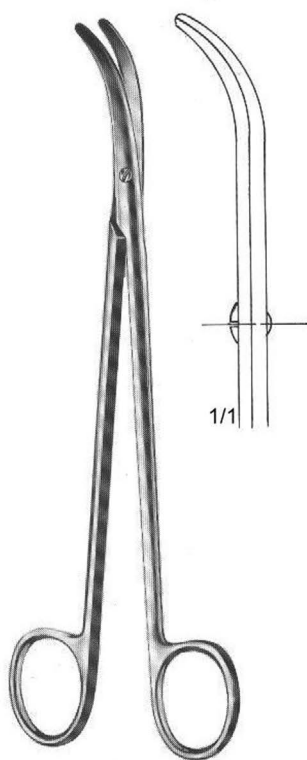


straight
05-488-22

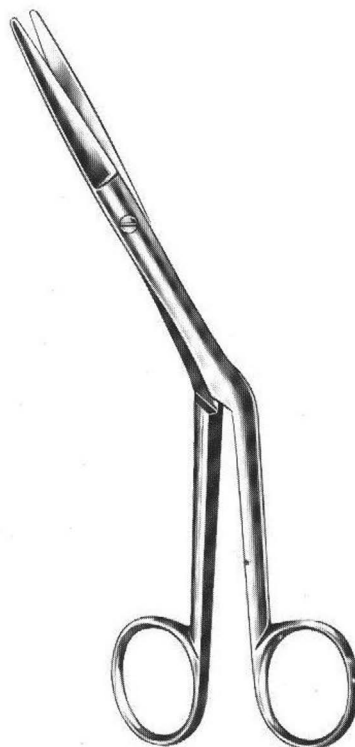
curved
05-489-22

Caplan
05-488-22 22 cm
05-489-22 22 cm

SCISSORS



Halle
05-490-19
19 cm

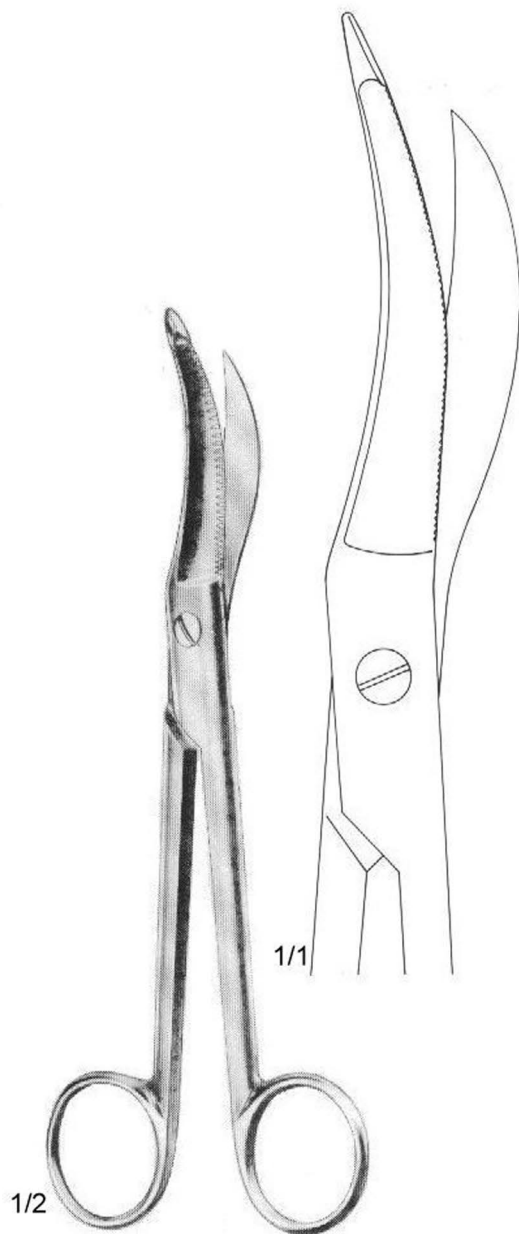


Heymann
05-494-19
19 cm

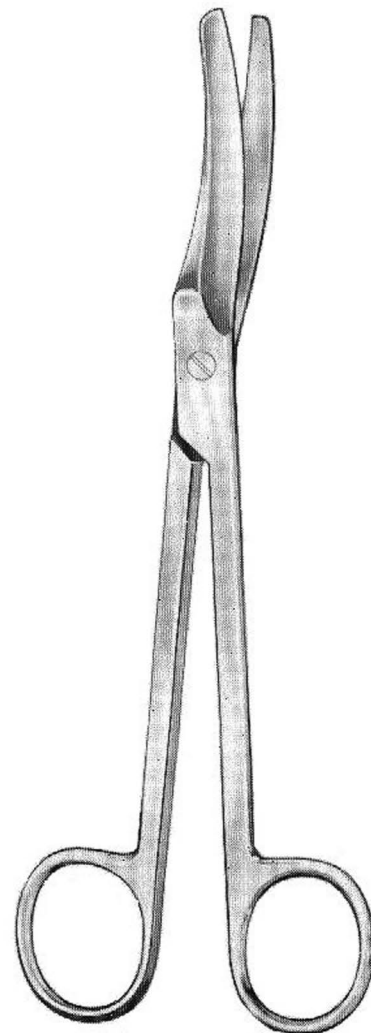


Knight
05-496-18
18 cm

SCISSORS

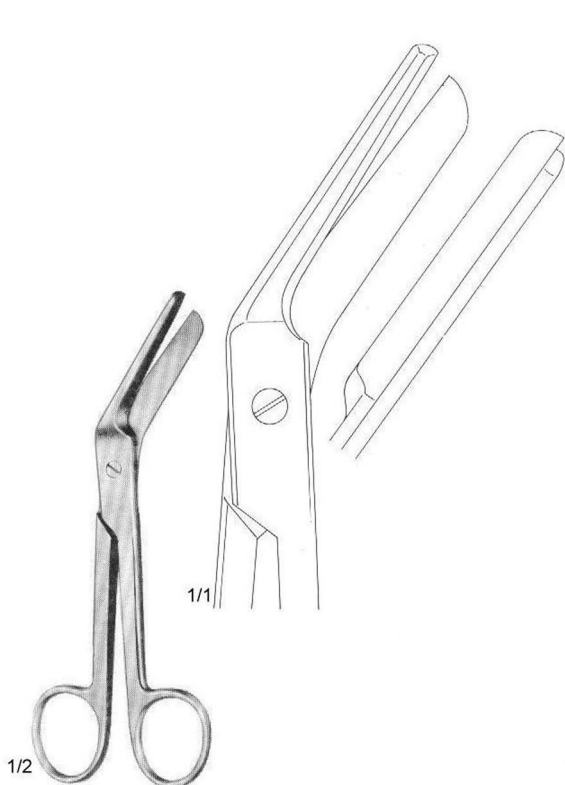


Waldmann
05-500-18
18 cm

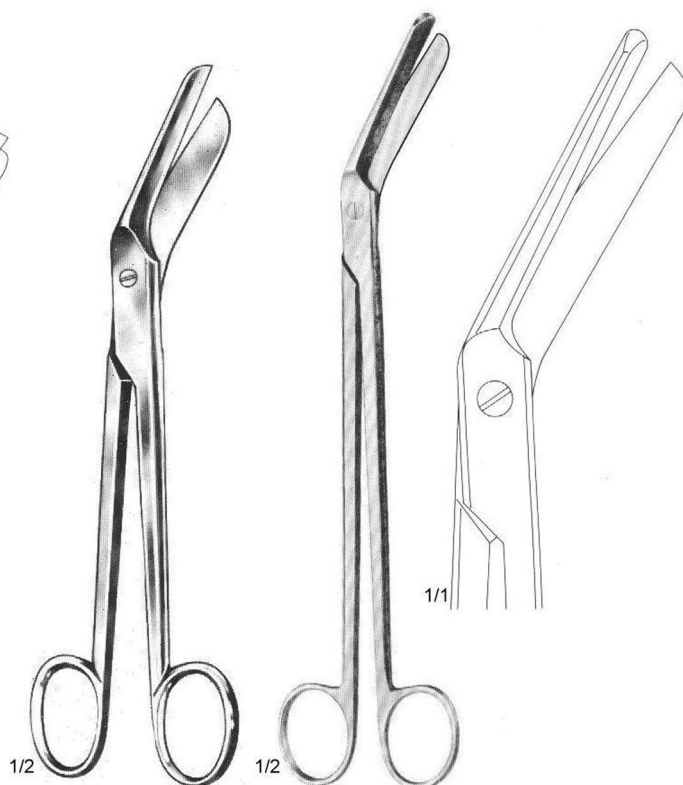


Waldmann
05-504-20
20 cm

SCISSORS



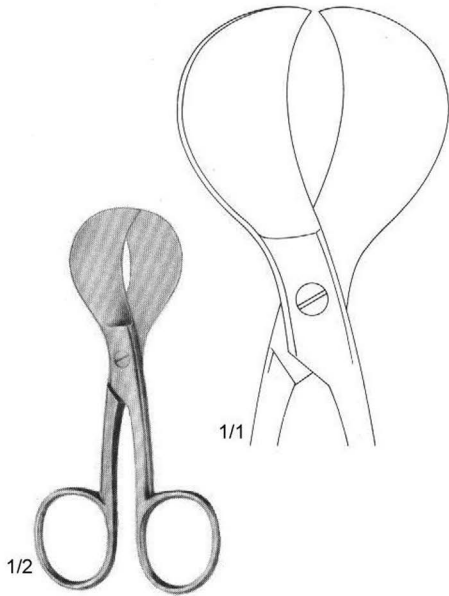
Braun - Stadler
05-510-14
14.5 cm



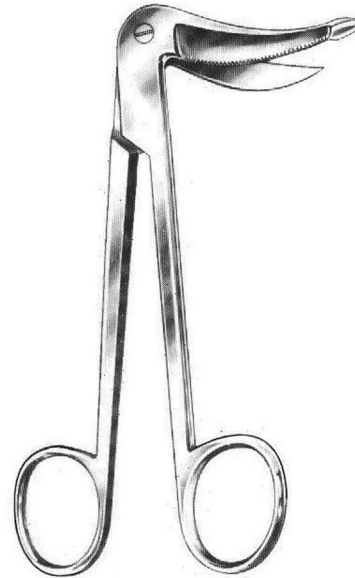
Braun - Stadler
05-510-20
20 cm

Braun - Stadler
05-510-22
22 cm

SCISSORS



Mod. USA
05-520-10 10.5 cm
05-520-12 12.0 cm



Marbach
05-523-15
15.5 cm



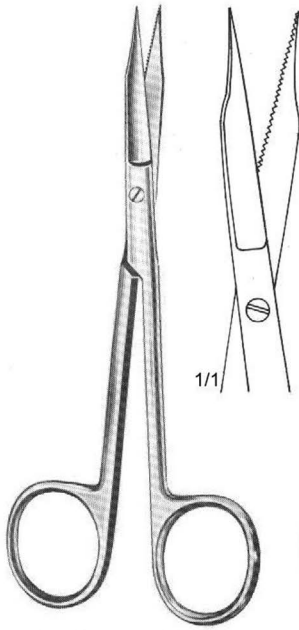
Schumacher
05-525-15
15.5 cm



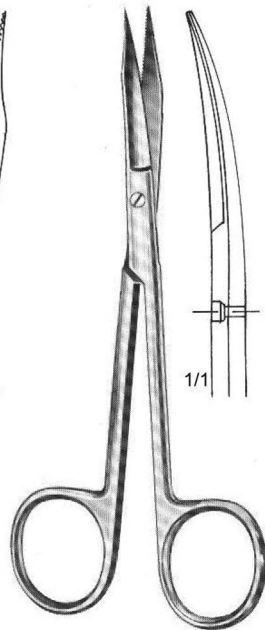
Busch
05-527-13 13 cm
05-527-16 16 cm

05-527-16

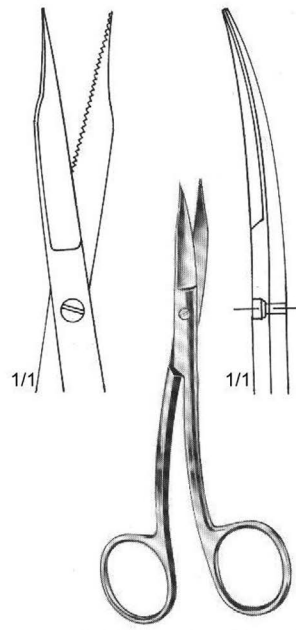
SCISSORS



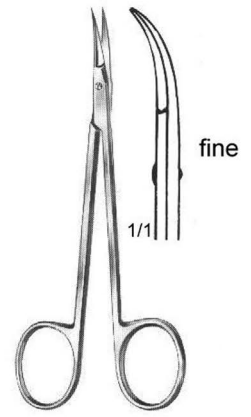
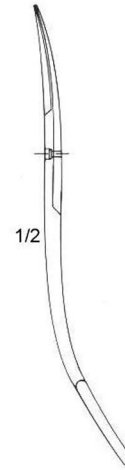
Goldman - Fox
05-530-13
13 cm



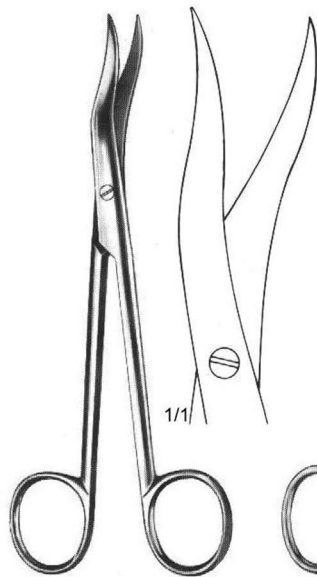
Goldman - Fox
05-531-13
13 cm



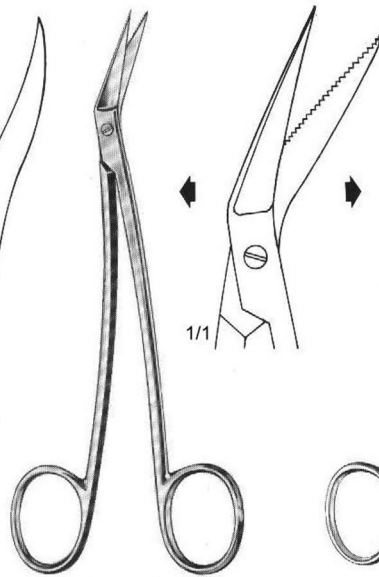
Goldman - Fox (Special)
05-533-13
13 cm



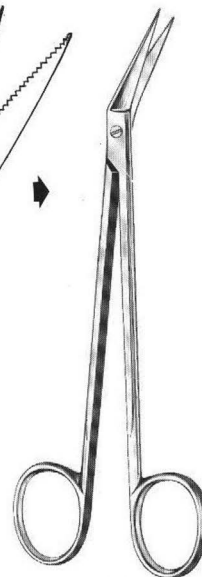
05-535-11
11.5 cm



05-537-16
16 cm

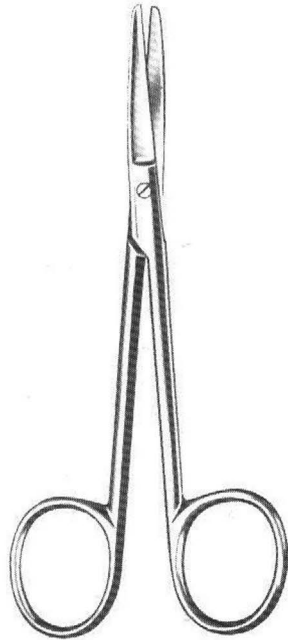


Locklin
05-538-16
16.5 cm



Locklin
05-539-16
16.5 cm

SCISSORS



Wagner
05-550-12 - 05-555-12
12 cm



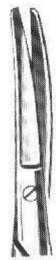
05-550-12



05-552-12



05-554-12



05-551-12



05-553-12



05-555-12

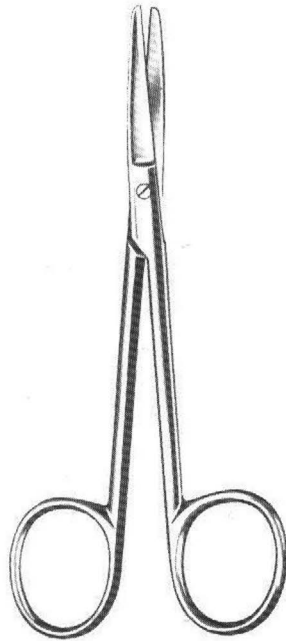


05-556-11
11 cm

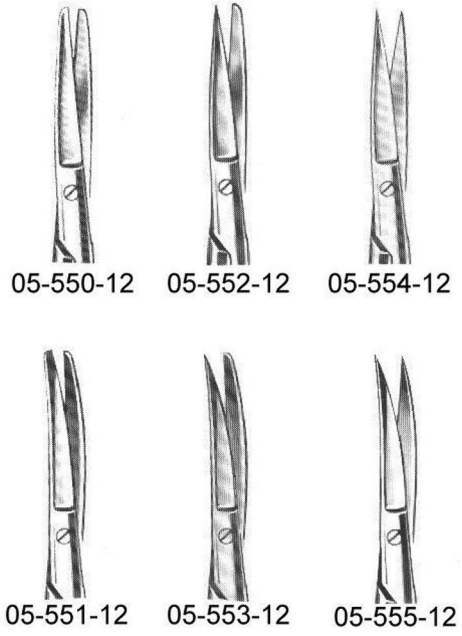


05-557-11
11 cm

SCISSORS



Wagner
05-550-12 - 05-555-12
12 cm

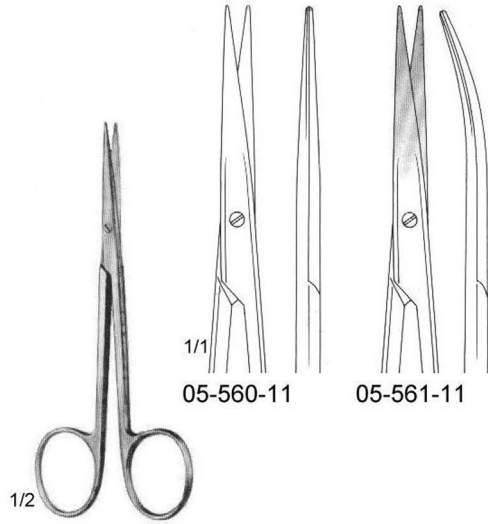


05-550-12 05-552-12 05-554-12
05-551-12 05-553-12 05-555-12

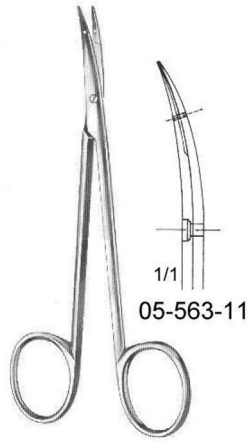


05-556-11 05-557-11
11 cm 11 cm

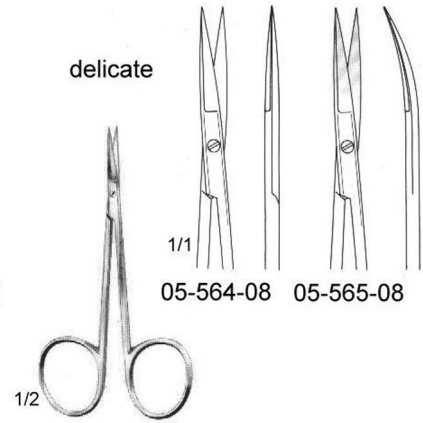
SCISSORS



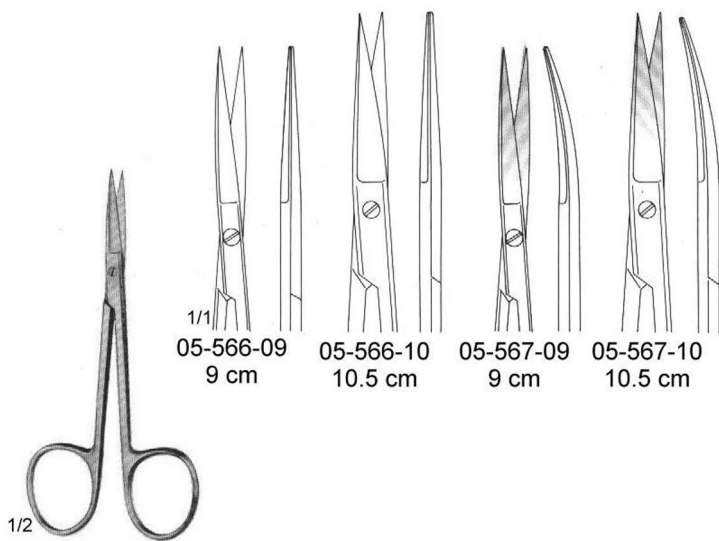
1/2
05-560-11 - 05-561-11
11.5 cm



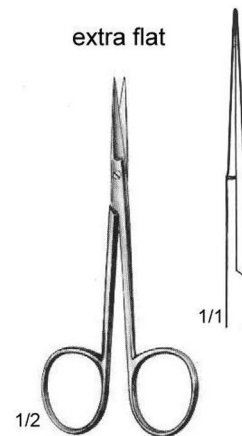
1/1
05-563-11 11.5 cm
05-563-14 14.0 cm



1/2
05-564-08 - 05-565-08
8 cm

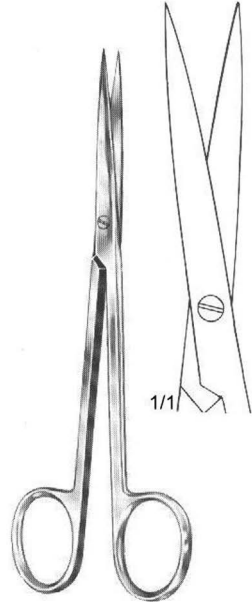


1/2
05-566-09 - 05-567-10

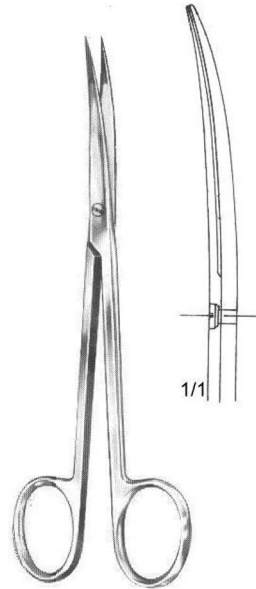


1/2
05-568-10
10 cm

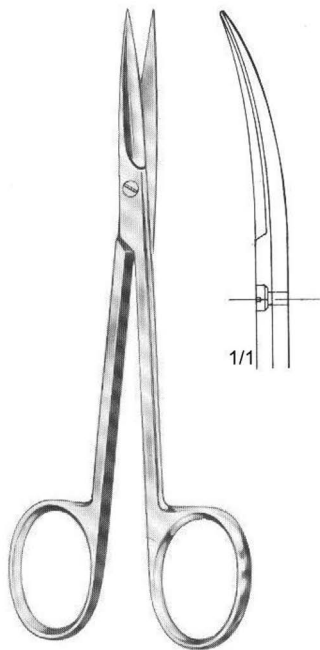
SCISSORS



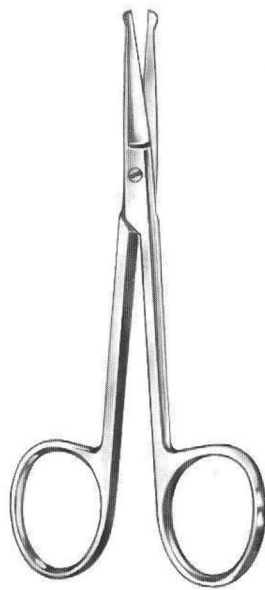
Brophy (Sullivan)
05-570-14
14.5 cm



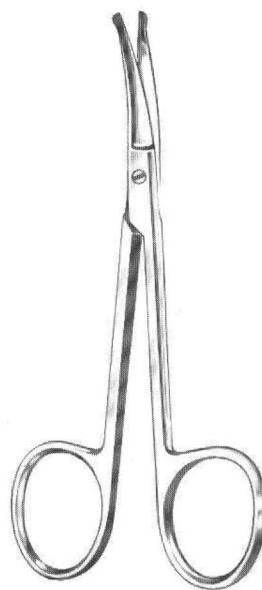
Brophy (Sullivan)
05-571-14
14.5 cm



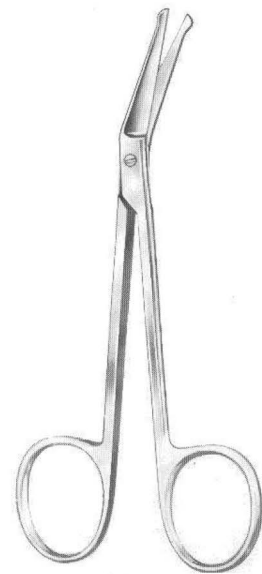
05-572-13
13 cm



05-574-10 10.5 cm
05-574-11 11.5 cm

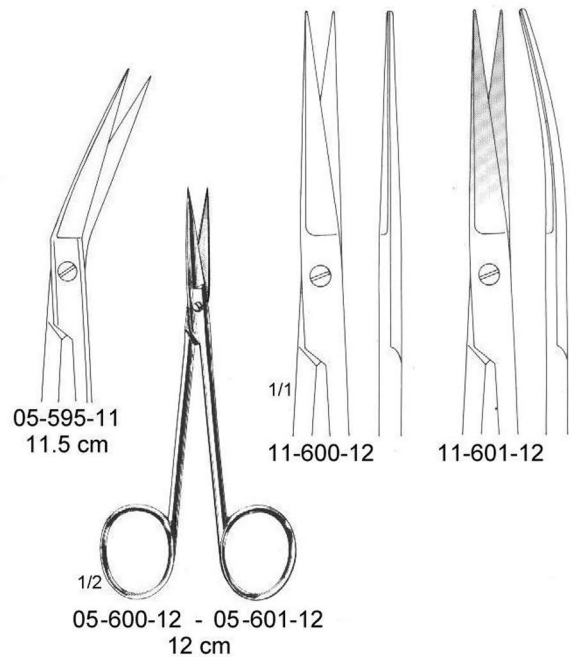
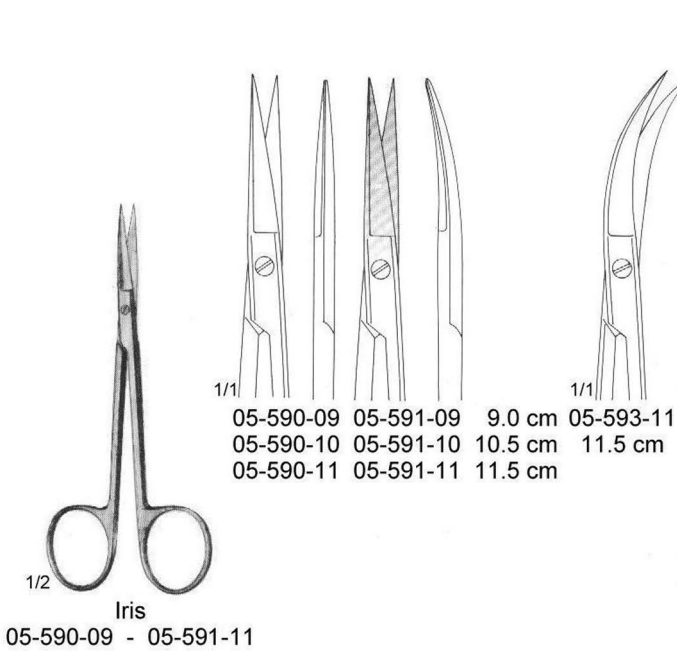
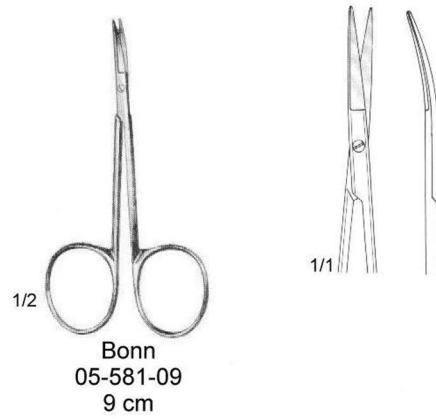
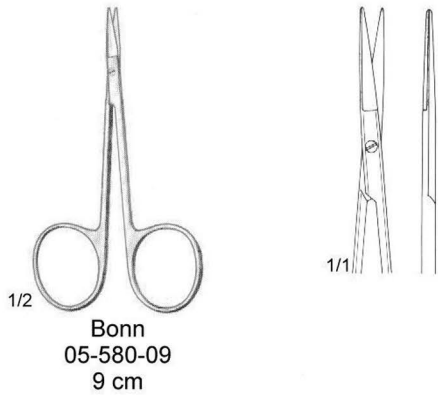


05-575-10 10.5 cm
05-575-11 11.5 cm

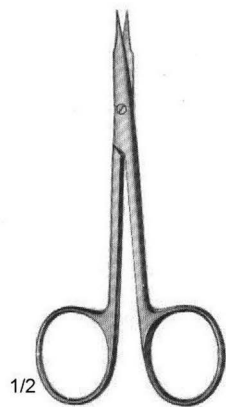


05-578-11
11.5 cm

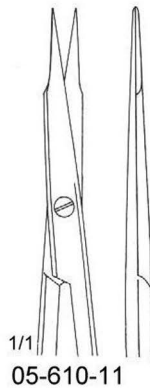
SCISSORS



SCISSORS

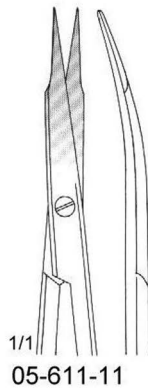


Stevens
05-610-11 - 05-613-11
11 cm



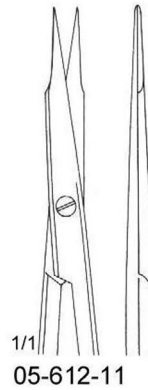
05-610-11

sharp



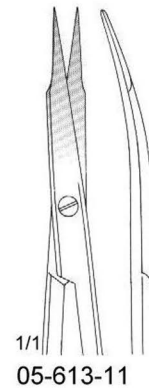
05-611-11

sharp



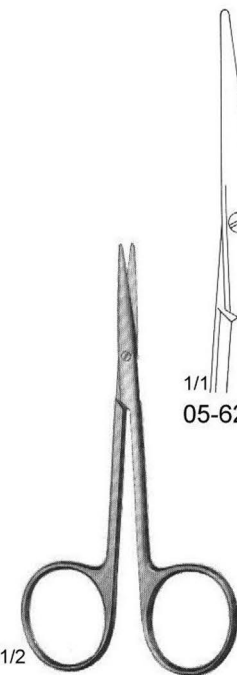
05-612-11

blunt

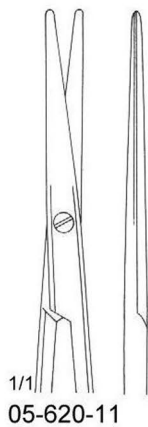


05-613-11

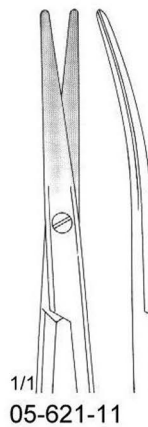
blunt



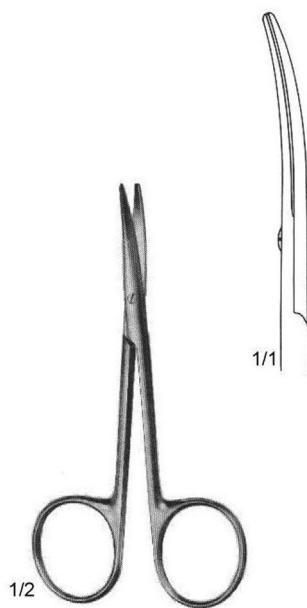
Strabismus
05-620-11 - 05-621-11
11.5 cm



05-620-11



05-621-11

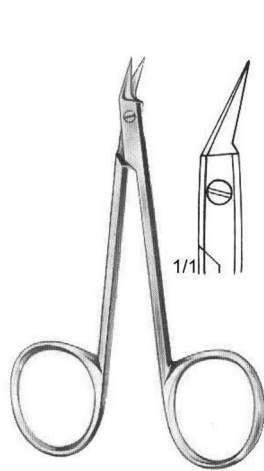


Enucleation
05-625-11
11.5 cm

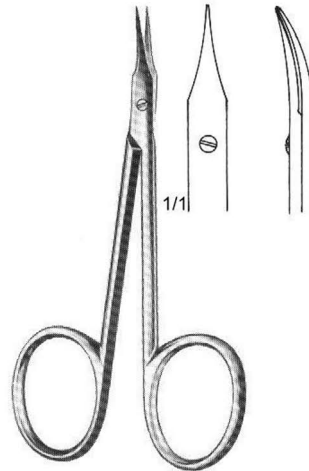


05-625-11

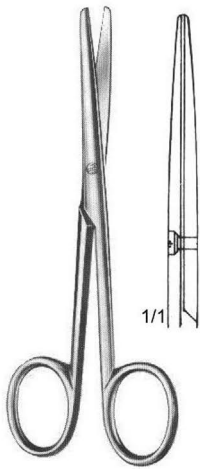
SCISSORS



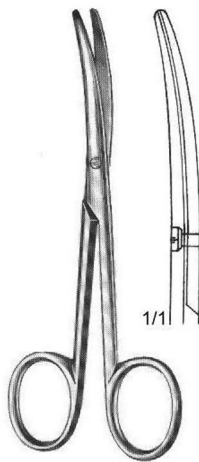
O'Brien
05-631-09
9 cm



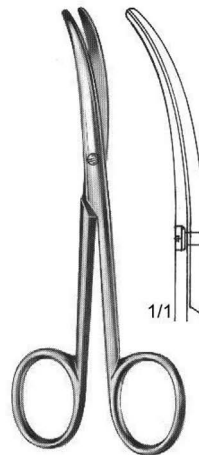
Walton
05-633-10
10 cm



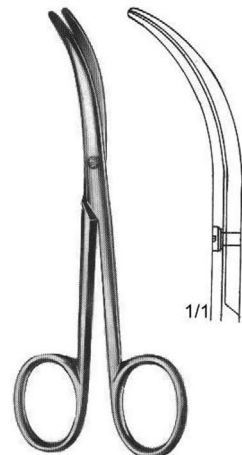
Landolt
05-636-12
12.5 cm



Landolt
05-637-12
12.5 cm



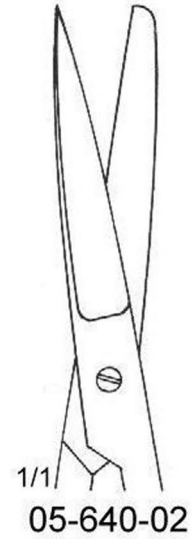
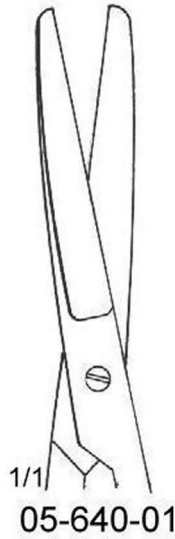
Landolt
05-638-12
12.5 cm



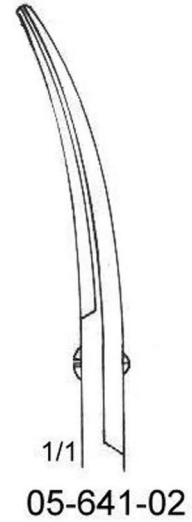
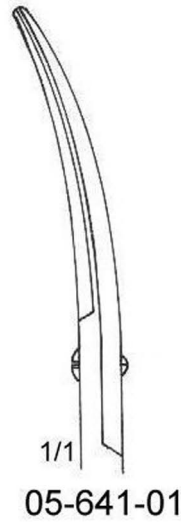
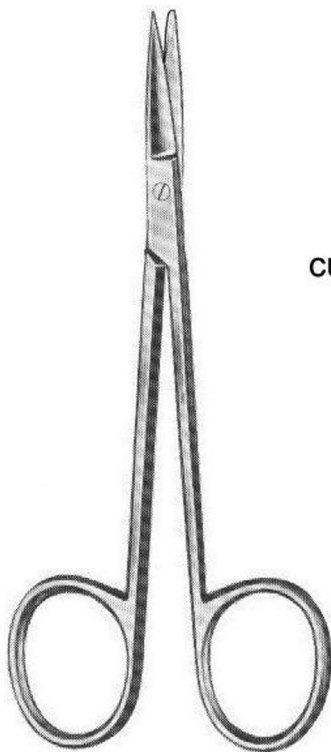
Landolt
05-639-12
12.5 cm

SCISSORS

straight

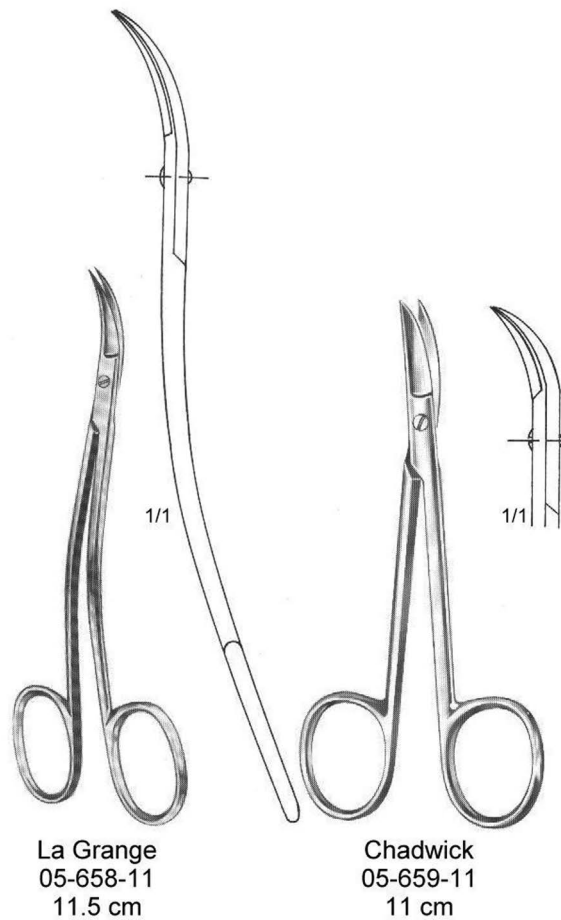
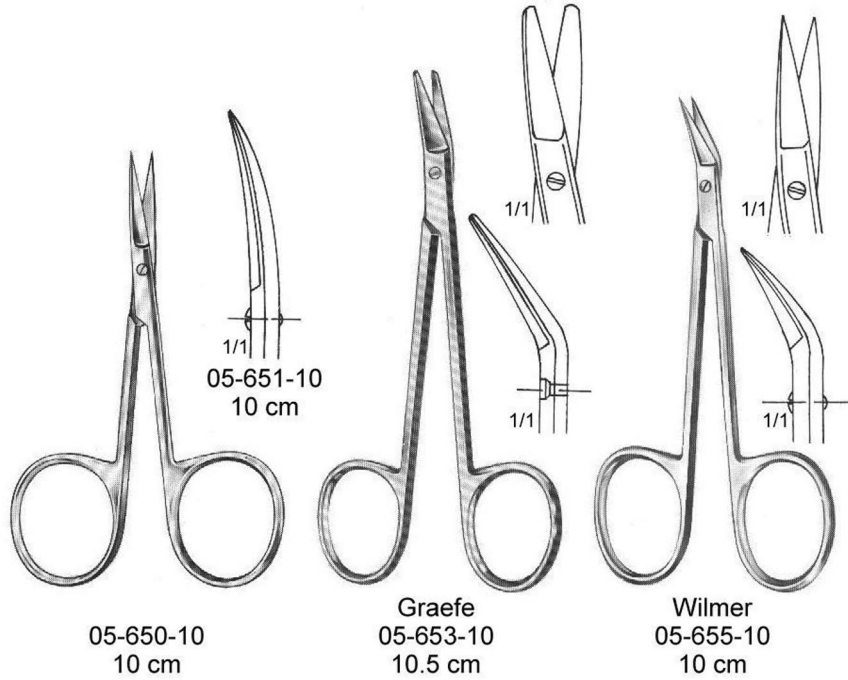


curved

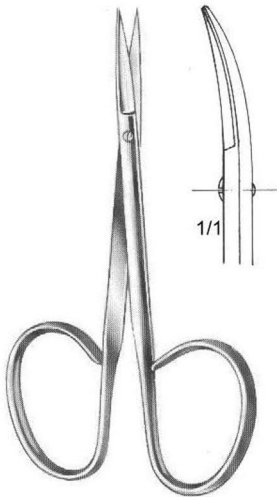


05-640-01 - 05-641-02
11.5 cm

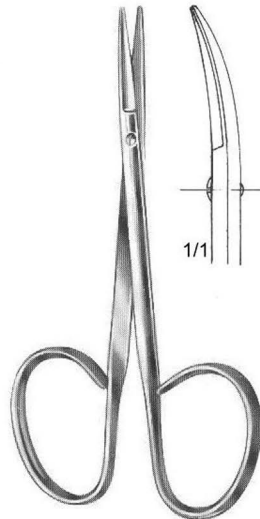
SCISSORS



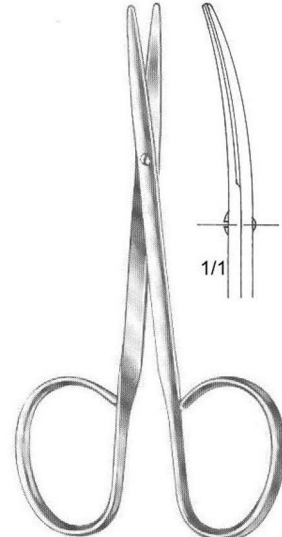
SCISSORS



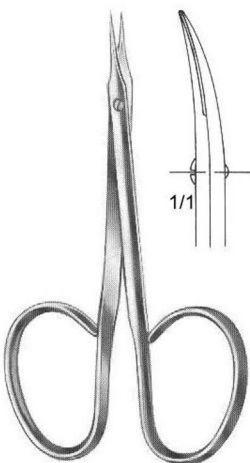
05-660-10 straight
05-661-10 curved
10 cm



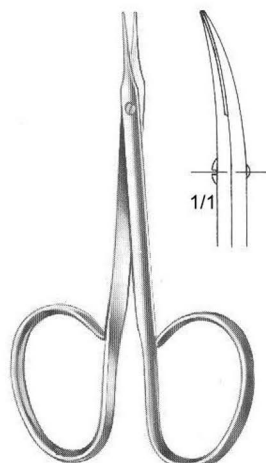
05-662-10 straight
05-663-10 curved
10 cm



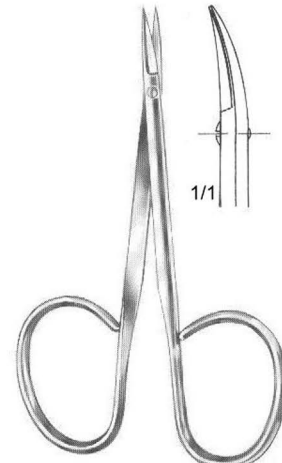
05-664-10 straight
05-665-10 curved
10 cm



05-670-10 straight
05-671-10 curved
9.5 cm

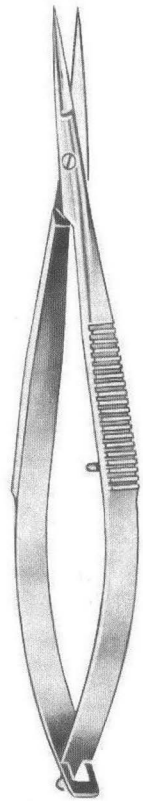


05-672-10 straight
05-673-10 curved
9.5 cm



05-674-10 straight
05-675-10 curved
9.5 cm

SCISSORS



05-680-12
05-682-12
05-684-12

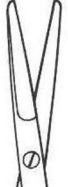
Fig. 1



Fig. 2

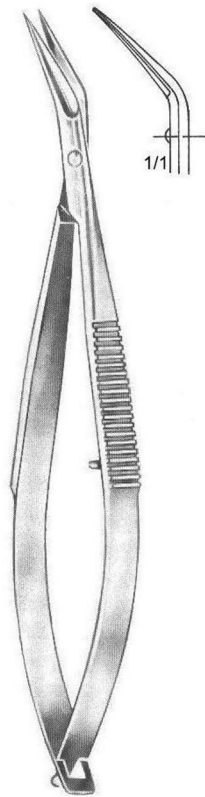


Fig. 3



Noyes
12 cm

Fig. 1
Fig. 2
Fig. 3



05-681-12
05-683-12
05-685-12



Wecker
11 cm



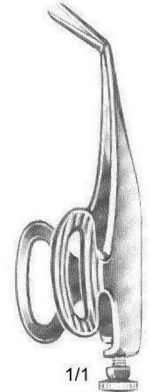
05-690-11



05-692-11

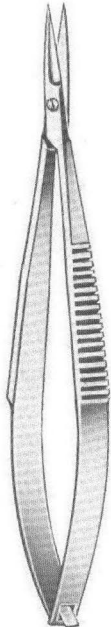


05-694-11

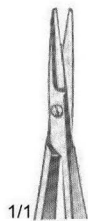


1/1
Barraquer
5.5 cm

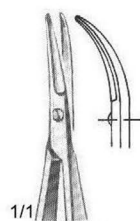
5 mm 05-698-05
7 mm 05-698-07
10 mm 05-698-10



Castroviejo
05-700-00
9 cm



1/1
05-700-02



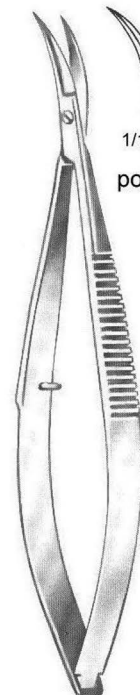
1/1
05-700-03



1/1
05-701-09



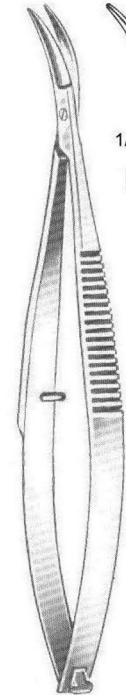
1/1
05-702-09



Castroviejo
05-703-10
10 cm



1/1
pointed

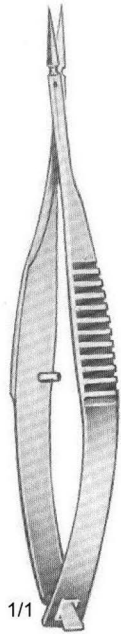


Castroviejo
05-705-10
10 cm

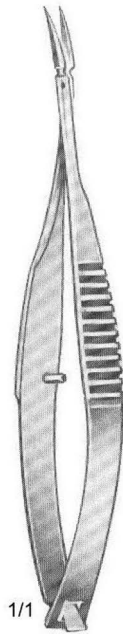


1/1
blunt

SCISSORS

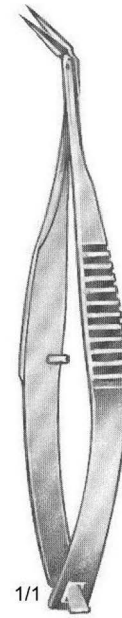


05-710-01
8.5 cm



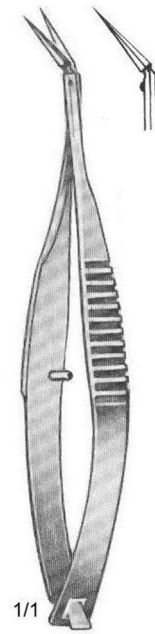
05-710-02
8.5 cm

angled



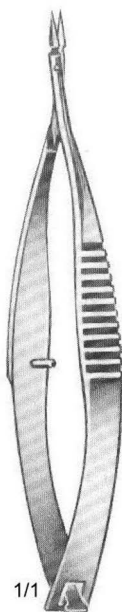
05-710-03
8.5 cm

angled on flat

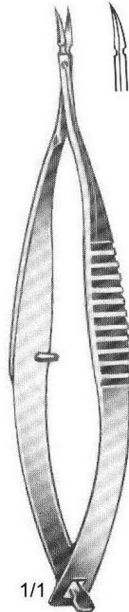


05-710-04
8.5 cm

Vannas Mod. Tubingen

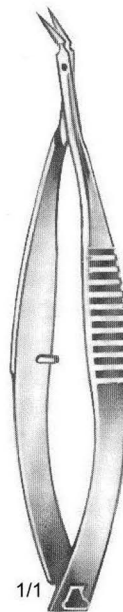


Vannas
05-716-01
8.5 cm



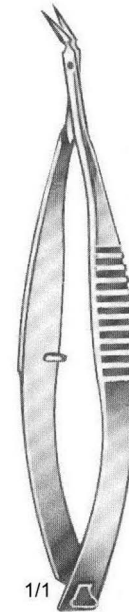
Vannas
05-716-02
8.5 cm

angled



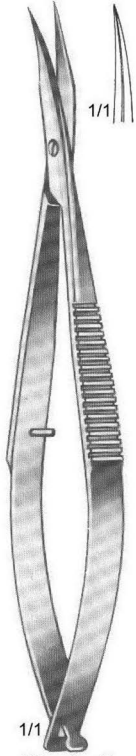
Vannas
05-716-03
8.5 cm

angled on flat

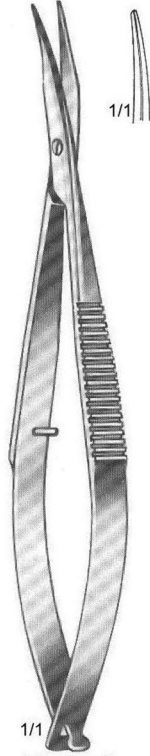


Vannas
05-716-04
8.5 cm

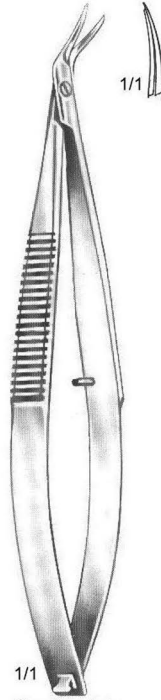
SCISSORS



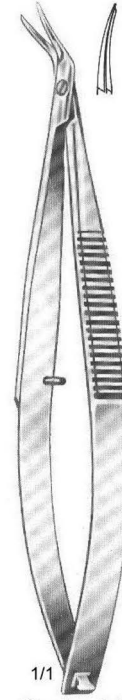
1/1
Westcott
05-720-11
11 cm



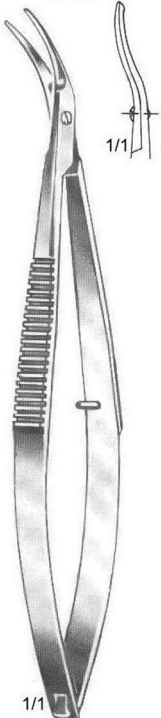
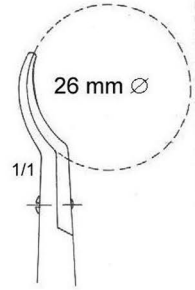
1/1
Westcott
05-722-11
11 cm



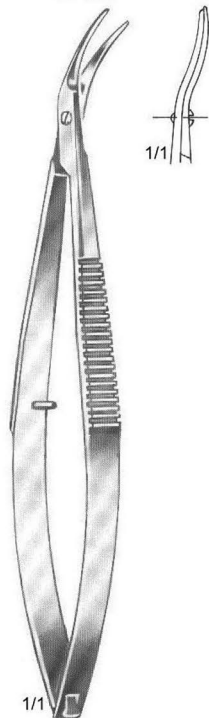
1/1
Castroviejo
05-725-01
10 cm



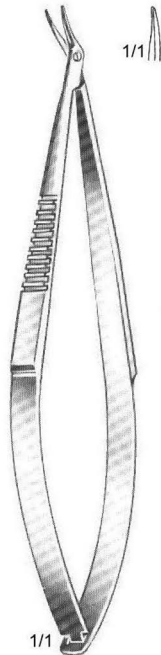
1/1
Castroviejo
05-725-02
10 cm



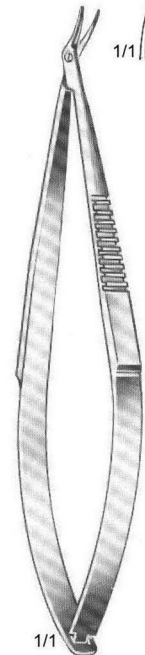
1/1
Castroviejo
05-726-01
11 cm



1/1
Castroviejo
05-726-02
11 cm

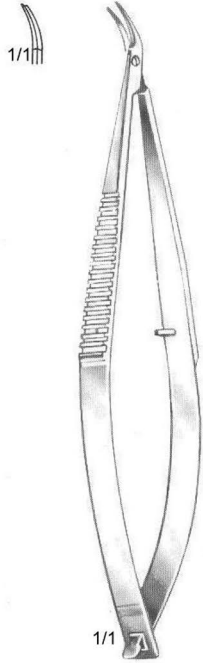


1/1
Troutman
05-728-01
10 cm

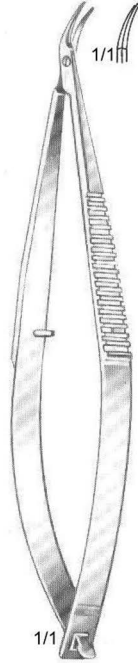


1/1
Troutman
05-728-02
10 cm

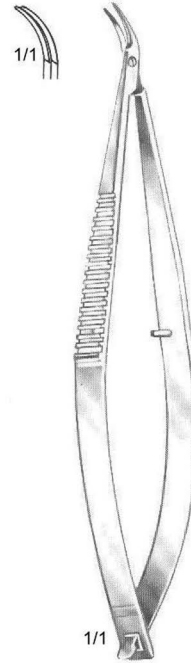
SCISSORS



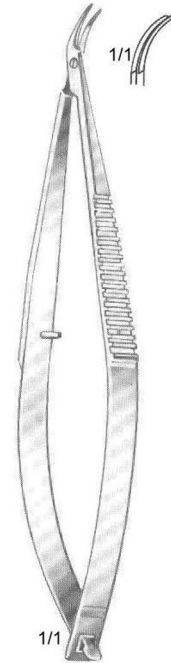
Katzin
05-730-01
10 cm



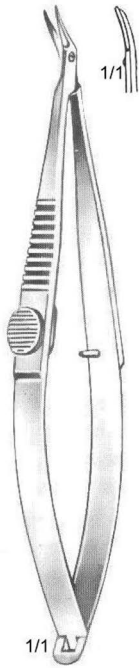
Katzin
05-730-02
10 cm



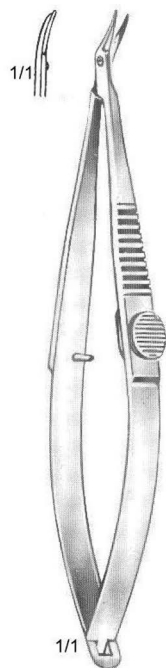
Katzin
05-731-01
11 cm



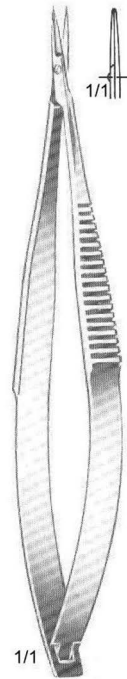
Katzin
05-731-02
11 cm



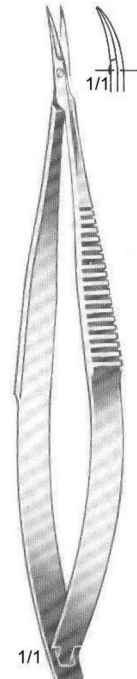
Katzin - Barraquer
05-732-01
10 cm



05-732-02
10 cm

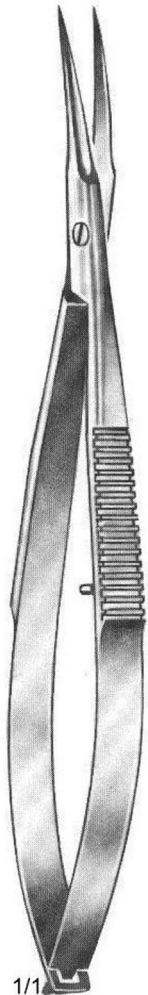


05-733-00
10 cm

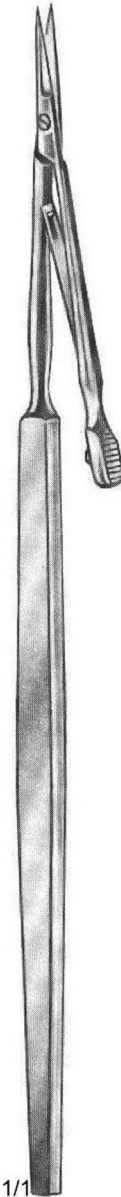


05-733-01
10 cm

SCISSORS

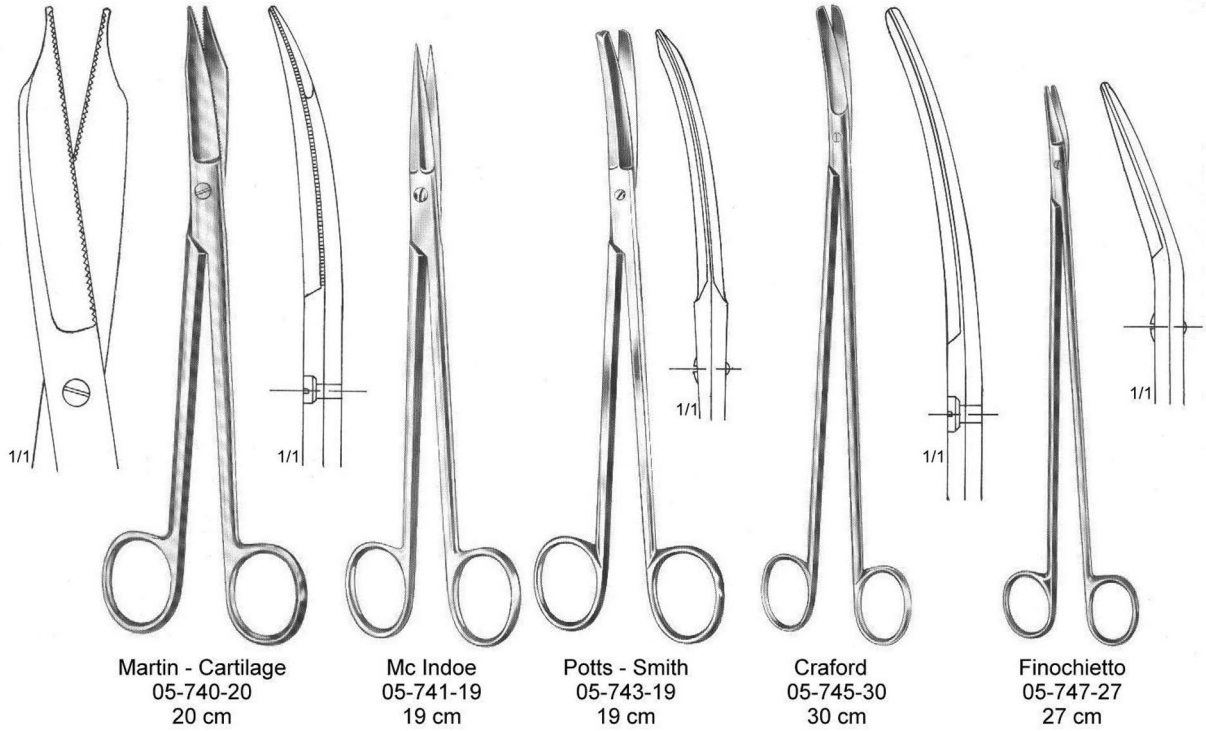


1/1
05-734-12
12 cm

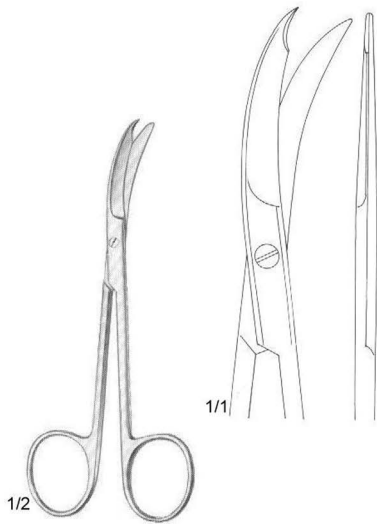


1/1
Noyes
05-735-15
15 cm

SCISSORS



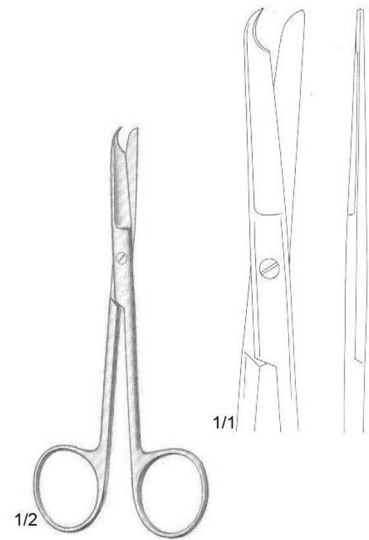
SCISSORS



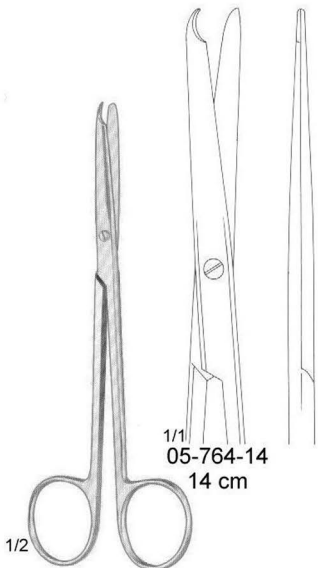
Northbent
05-761-13
13 cm



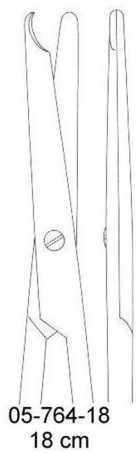
Spencer
05-762-09 9 cm
05-762-11 11 cm



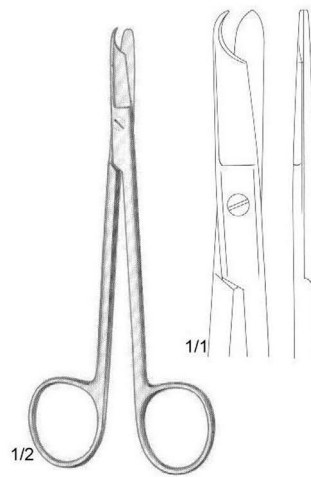
Spencer
05-762-13
13 cm



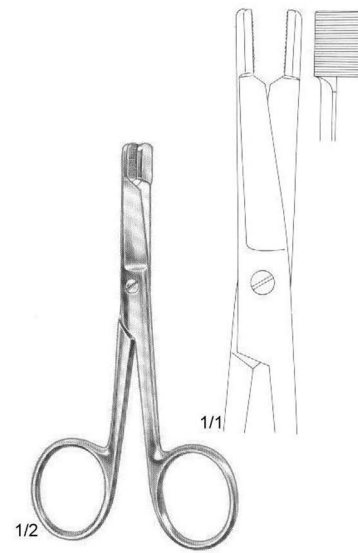
Buck
05-764-14 - 05-764-18



05-764-18
18 cm



Littauer
05-766-14
14 cm

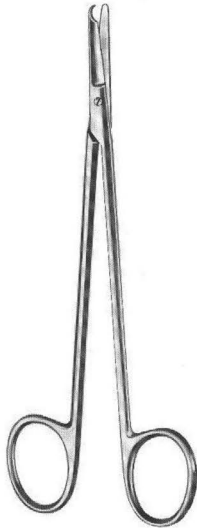


Eiselsberg
05-768-12
12 cm

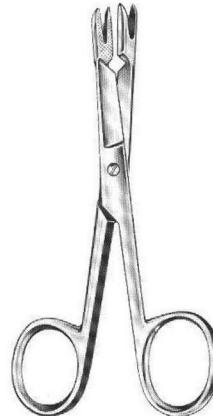
SCISSORS



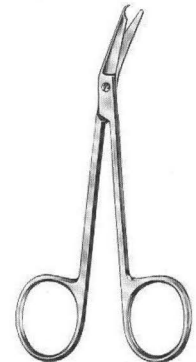
Spencer - Delicate
05-770-11
11 cm



05-772-16
16 cm



Schoemaker - Loth
05-774-12
12.5 cm

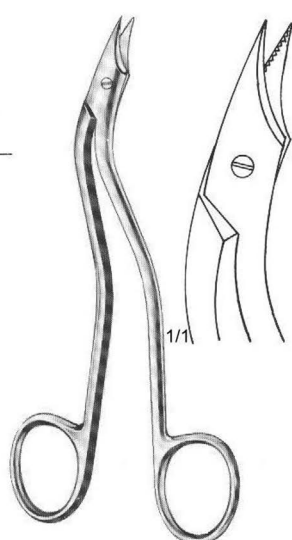
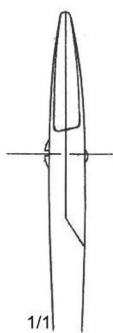


05-776-11
11.5 cm

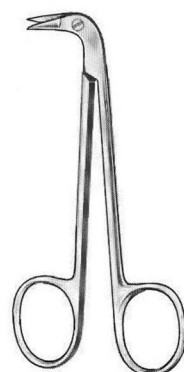
SCISSORS



Shortbent
05-780-09
9 cm



Heath
05-782-15
15 cm

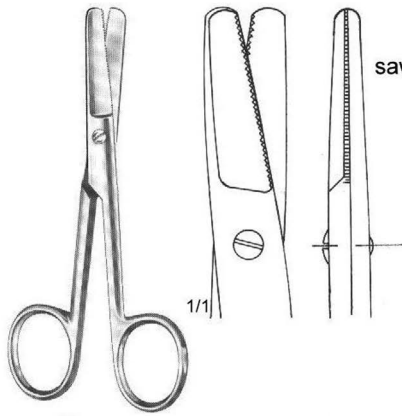


05-784-10
10.5 cm

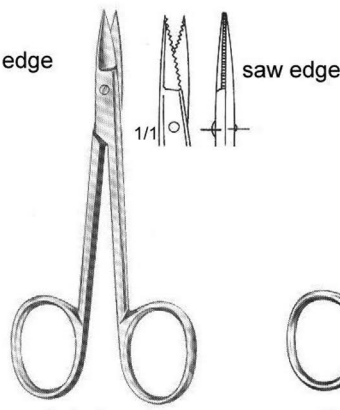


05-786-12
12 cm

SCISSORS



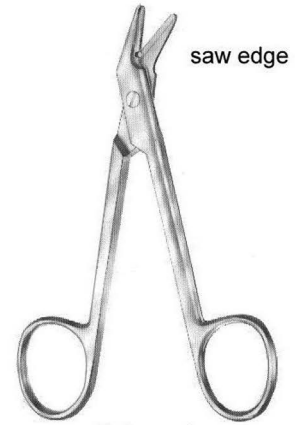
Harvey
05-790-12
12.5 cm



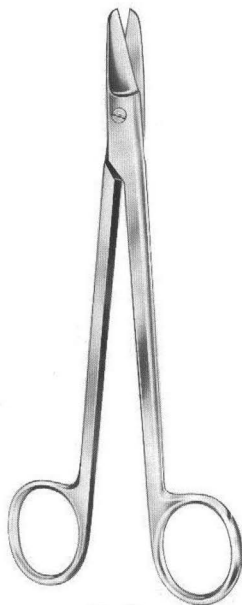
Schuknecht
05-791-10
10 cm



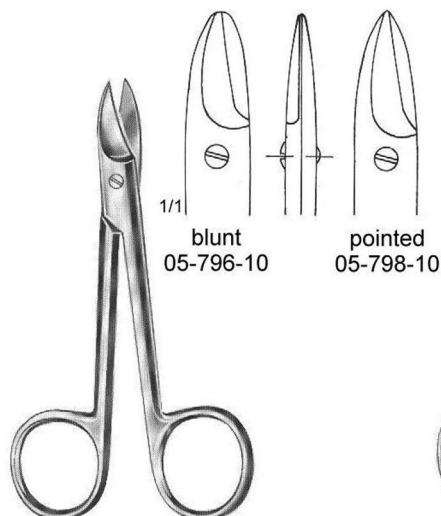
Schuknecht
05-792-11
11 cm



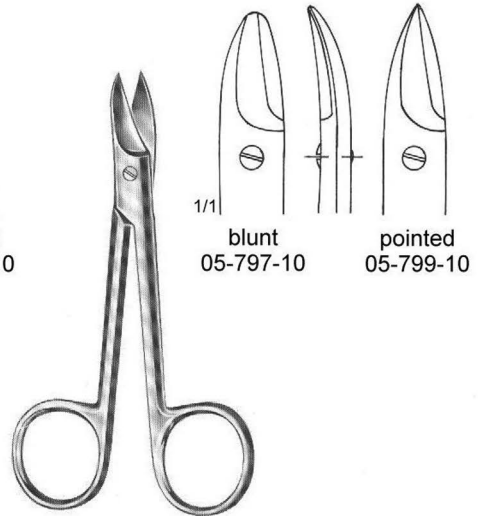
Universal
05-794-12
12 cm



Smith
05-795-17
17.5 cm

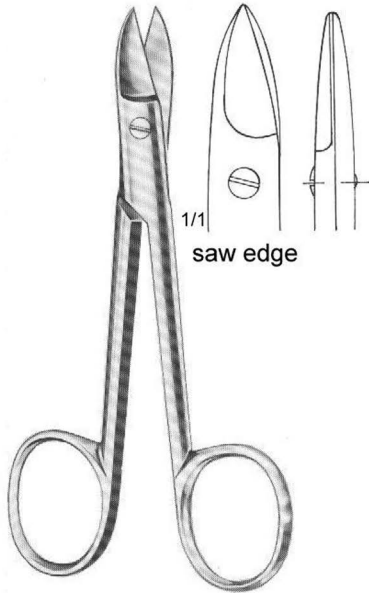


Bee Bee
10.5 cm

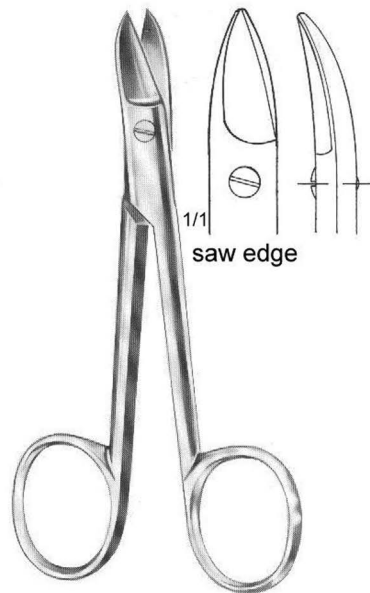


Bee Bee
10.5 cm

SCISSORS



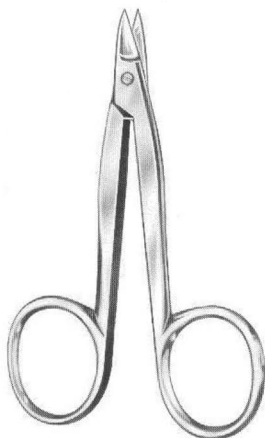
Bee Bee
05-800-12
12 cm



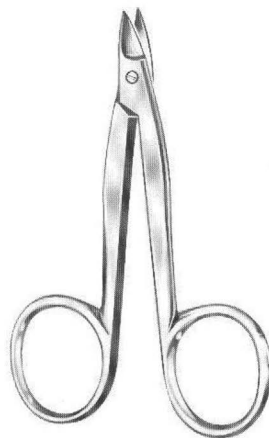
Bee Bee
05-801-12
12 cm



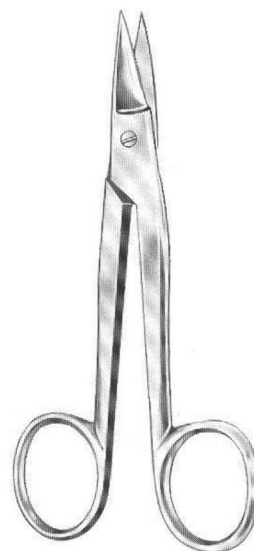
05-805-10
10.5 cm



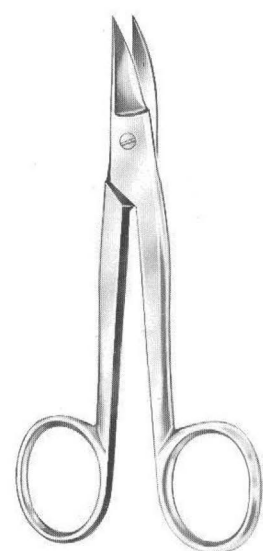
05-806-09
9 cm



05-807-09
9 cm

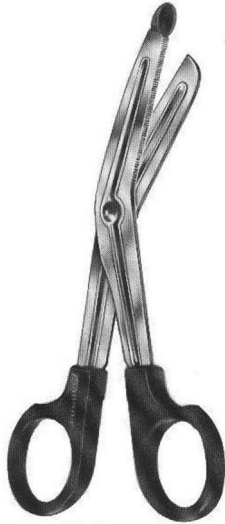


05-808-11
11 cm

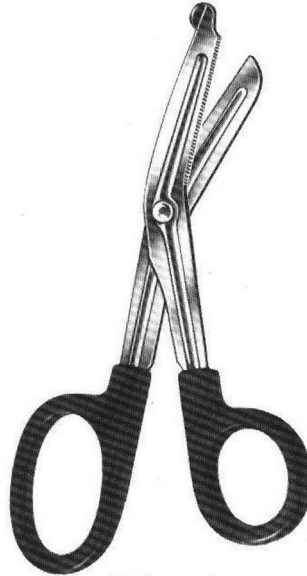


05-809-11
11 cm

SCISSORS



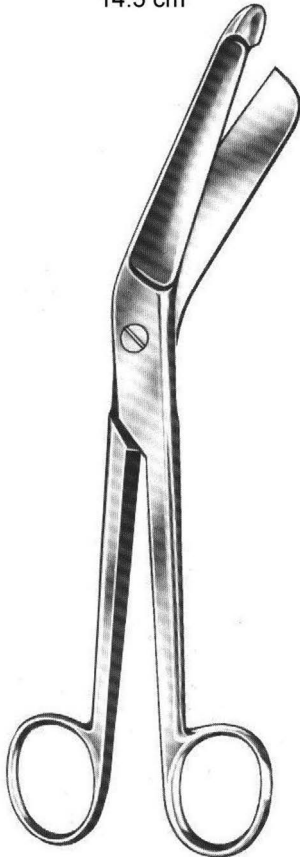
Universal
05-810-14
14.5 cm



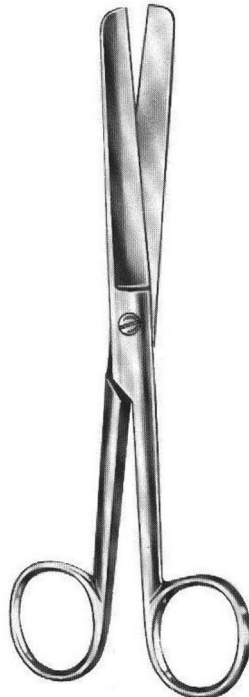
Universal
05-810-16
16 cm



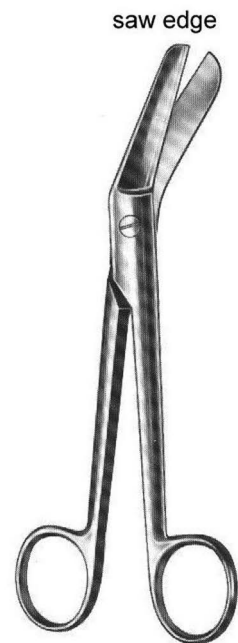
Universal
05-810-18
18 cm



Bergmann
05-812-23
23 cm

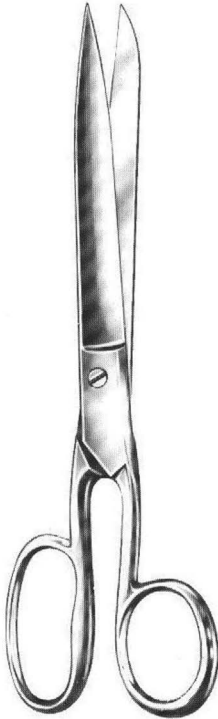


Lange
05-813-18
18 cm

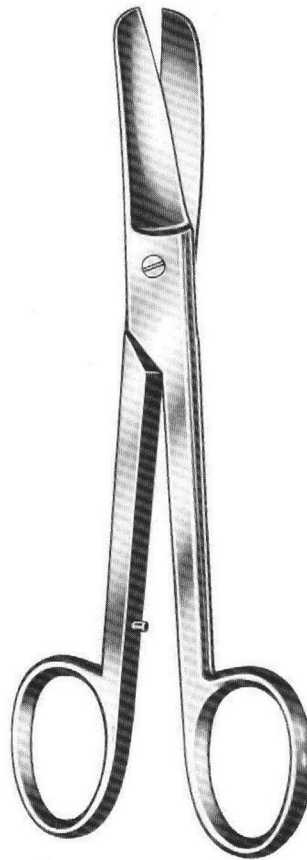


saw edge
05-814-17
17 cm

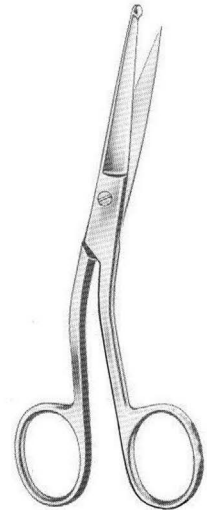
SCISSORS



Smith (Mod. USA)
05-815-16 16 cm
05-815-18 18 cm
05-815-20 20 cm
05-815-23 23 cm

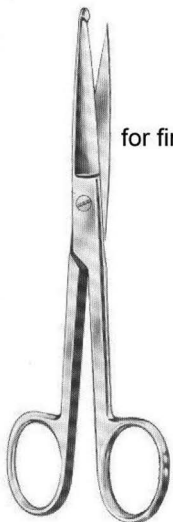


Lorenz
05-817-23
23 cm



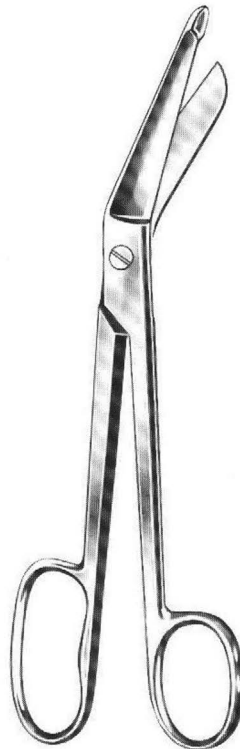
Knowles
05-819-14
14 cm

saw edge

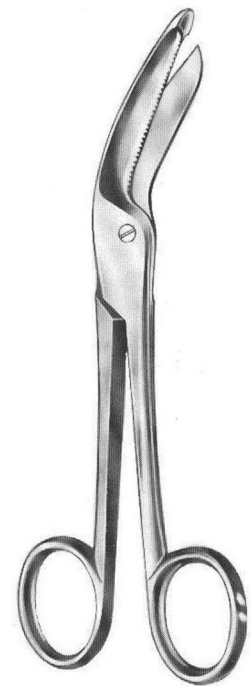


for fingers

Knowles
05-820-14
14 cm

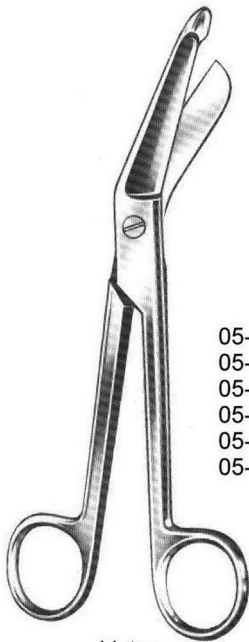


Lister
05-823-18 18 cm
05-823-21 21 cm



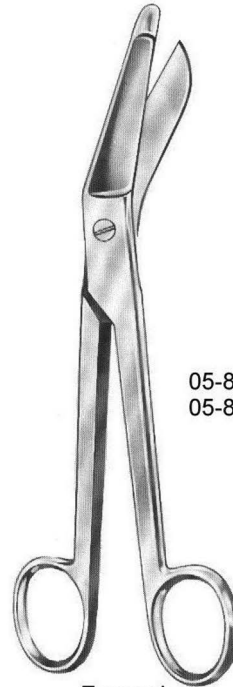
Lister - Excentric
05-826-16 16 cm
05-826-19 19 cm

SCISSORS



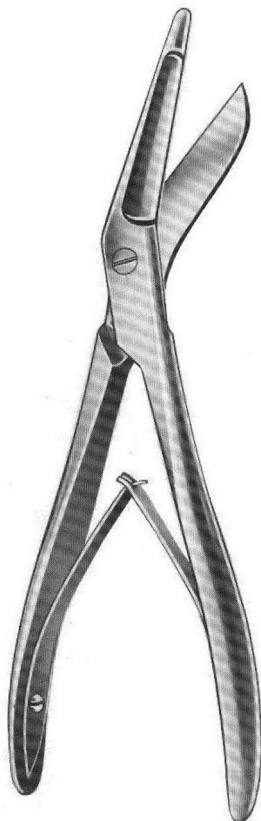
Lister

05-830-09 9.0 cm
05-830-11 11.0 cm
05-830-14 14.0 cm
05-830-15 15.5 cm
05-830-18 18.0 cm
05-830-20 20.0 cm

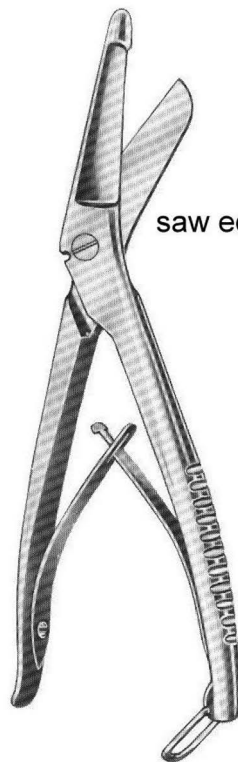


Esmarch

05-832-20 20 cm
05-832-22 22 cm



Seutin
05-834-23
23 cm



saw edge

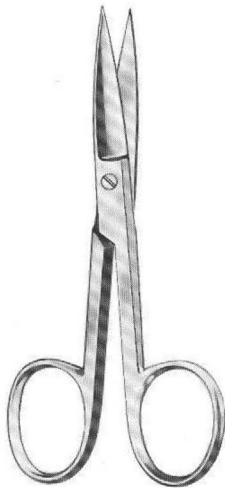
05-836-20
20 cm



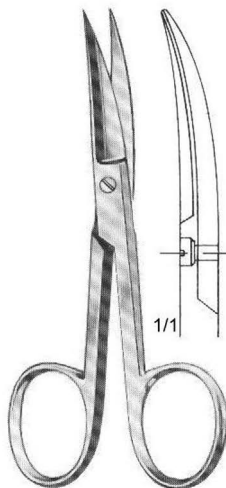
Bruns
24 cm

saw edge
05-838-24
smooth
05-839-24

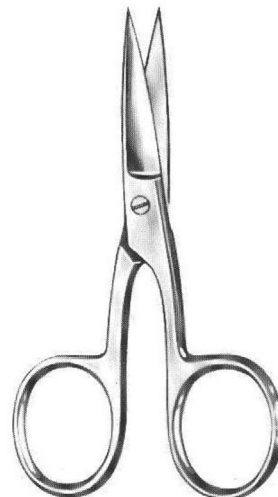
SCISSORS



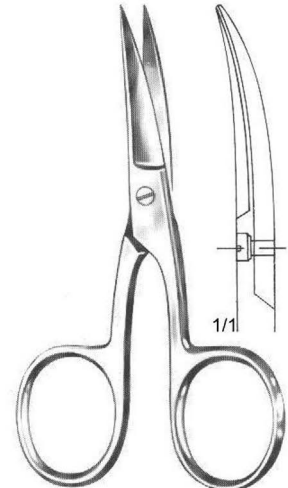
05-840-09 9 cm
05-840-10 10 cm



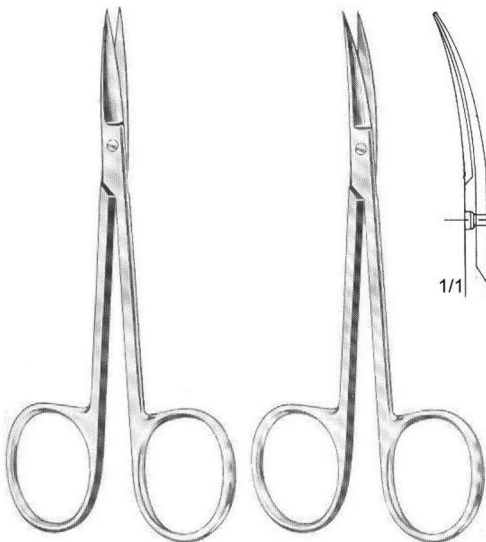
05-841-09 9 cm
05-841-10 10 cm



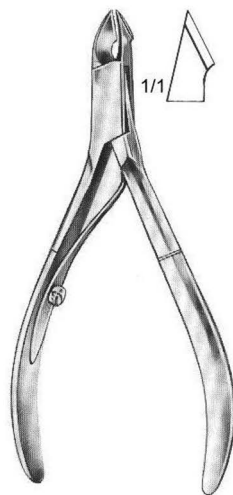
05-842-09 9 cm
05-842-10 10 cm



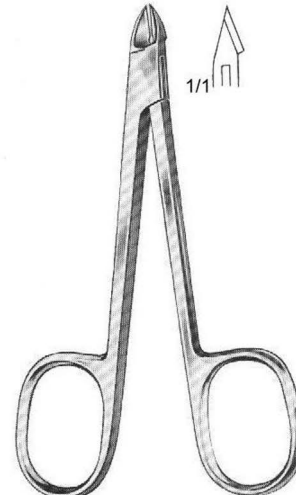
05-843-09 9 cm
05-843-10 10 cm



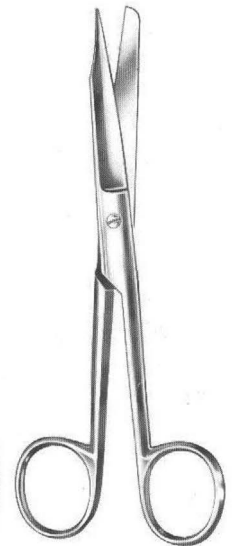
05-844-10 10 cm 05-845-10 10 cm
05-844-11 11 cm 05-845-11 11 cm



05-846-11
10.5 cm

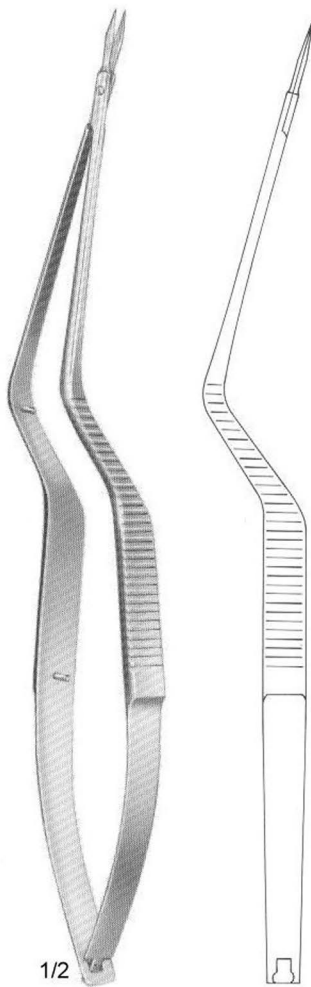


05-847-11
10.5 cm

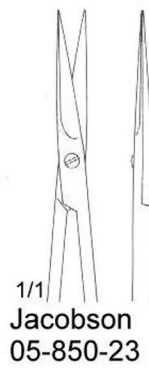


Konig
05-848-13 13 cm
05-848-15 15 cm

SCISSORS



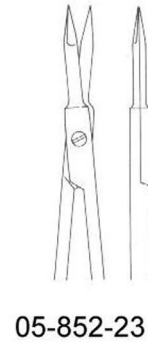
1/2
05-850-23 - 05-853-23
22.5 cm



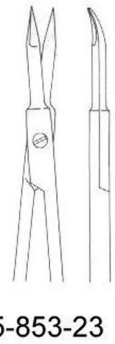
1/1
Jacobson
05-850-23



Potts
05-851-23

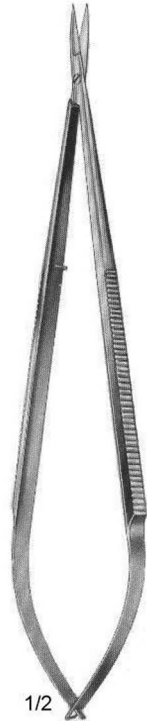


05-852-23



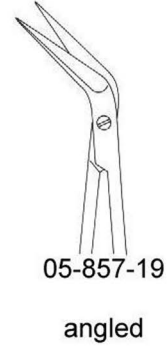
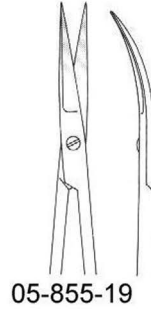
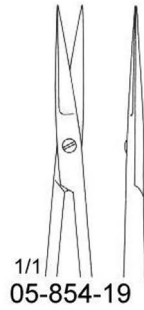
05-853-23

SCISSORS



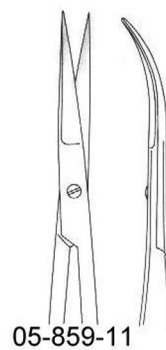
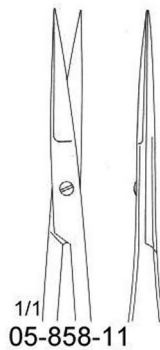
1/2

05-854-19 - 05-857-19
18.5 cm

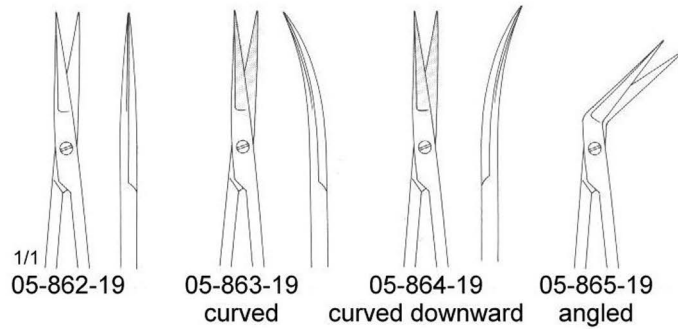
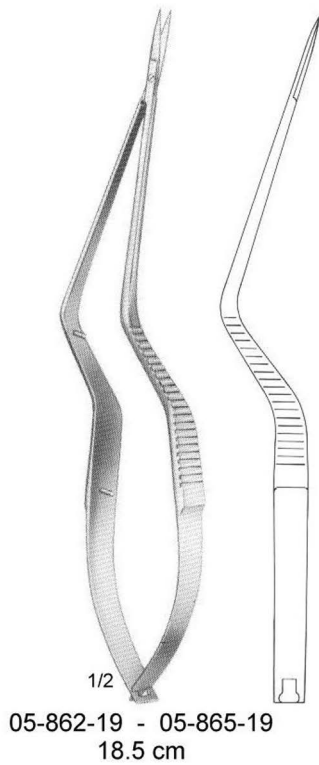
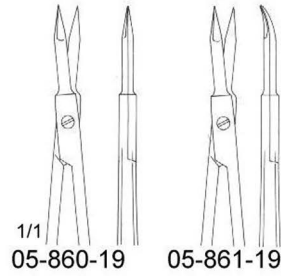
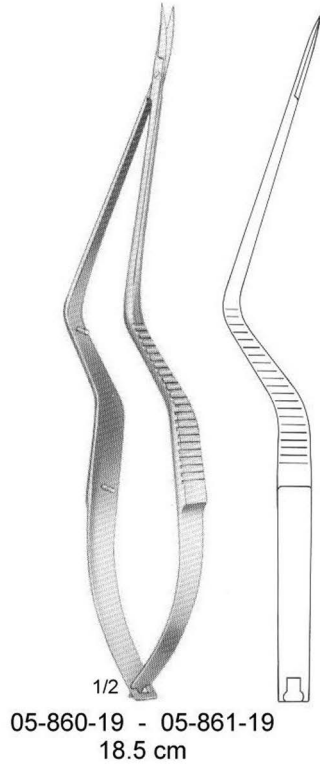


1/2

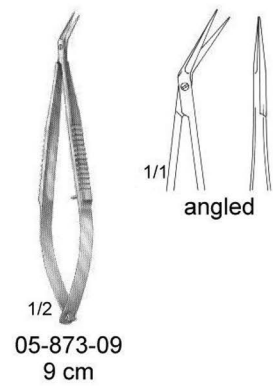
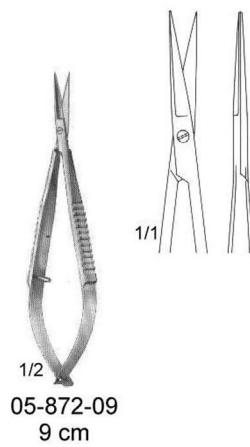
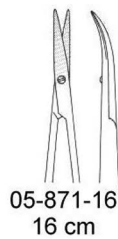
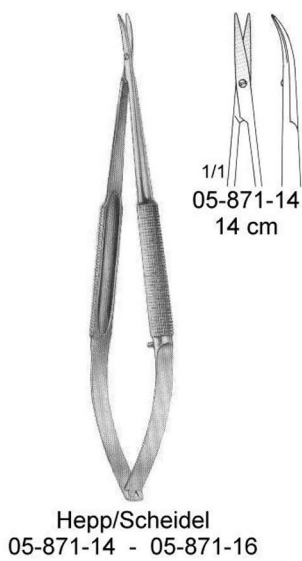
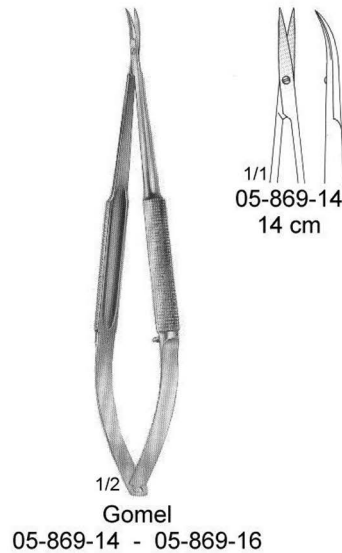
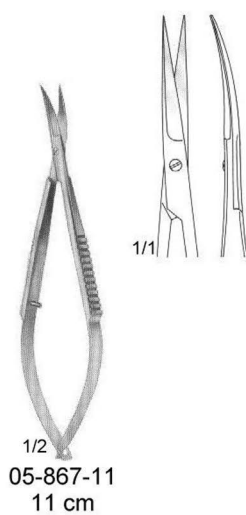
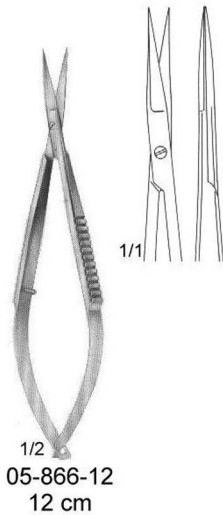
Westcott
05-858-11 - 05-859-11
11.5 cm



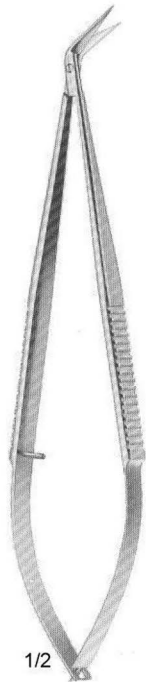
SCISSORS



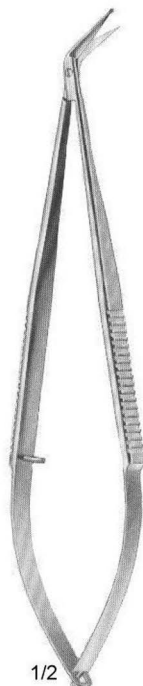
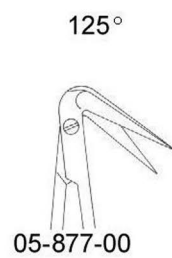
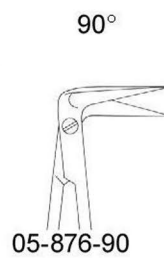
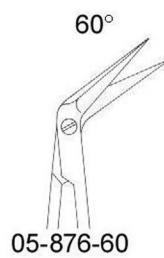
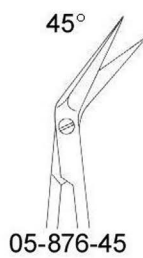
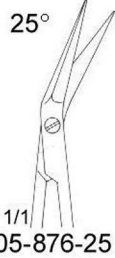
SCISSORS



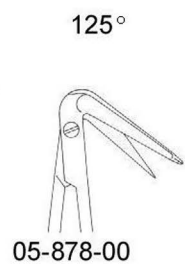
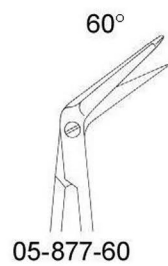
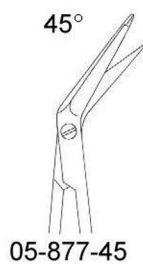
SCISSORS



1/2
05-876-25 - 05-877-00
18 cm



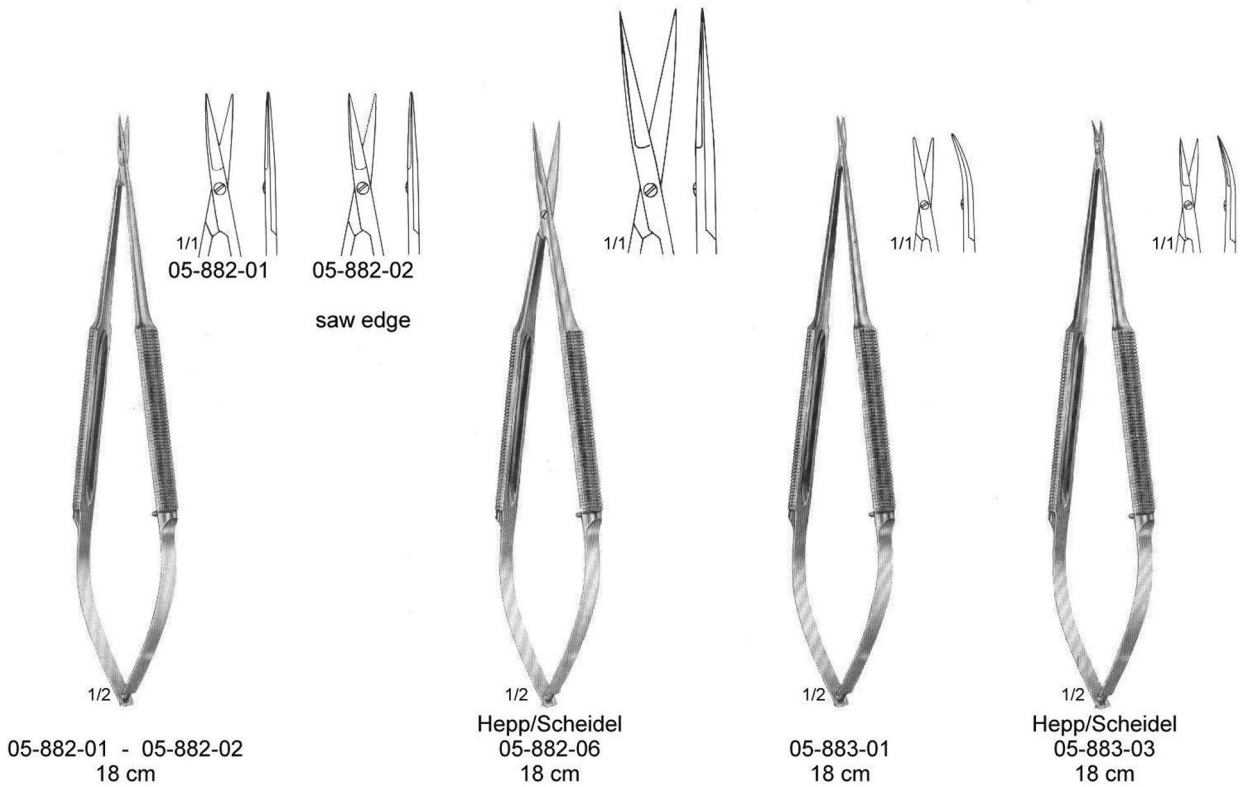
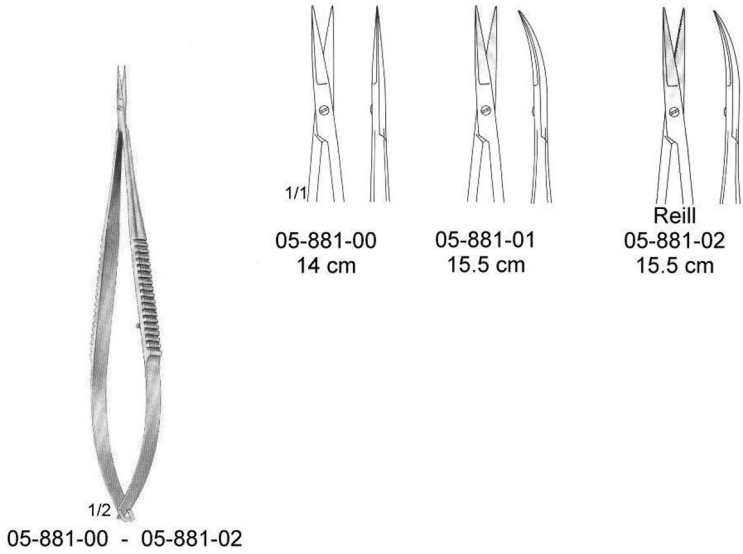
1/2
05-877-25 - 05-878-00
18 cm



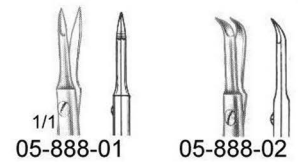
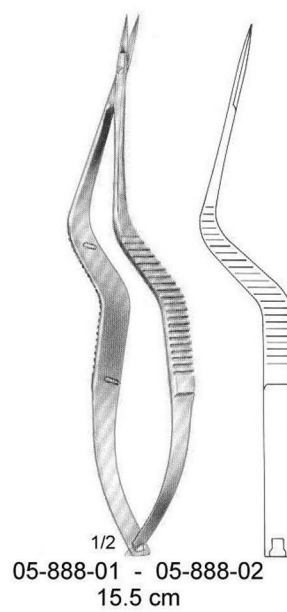
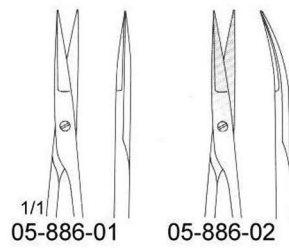
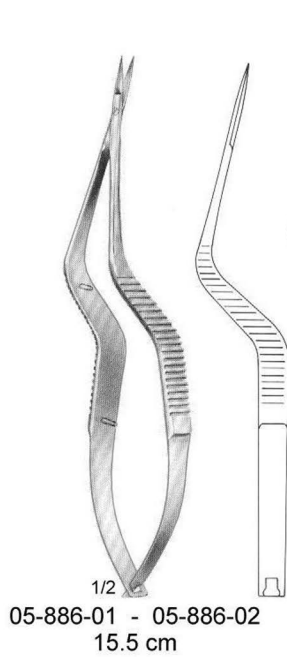
with probe

SCISSORS

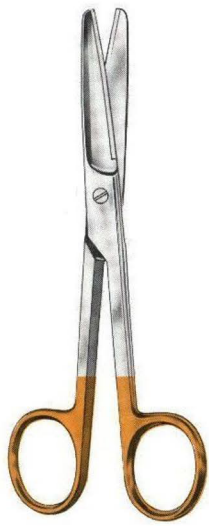
one blade saw edge



SCISSORS

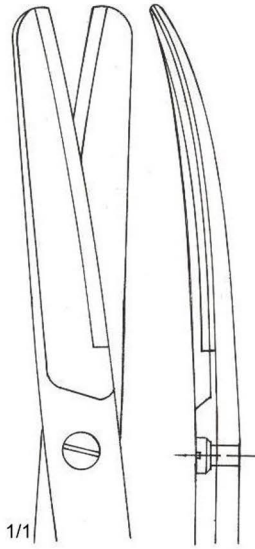
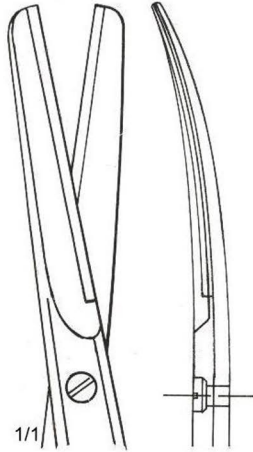


SCISSORS

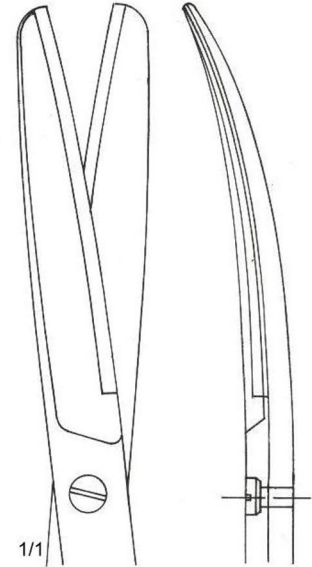


Standard

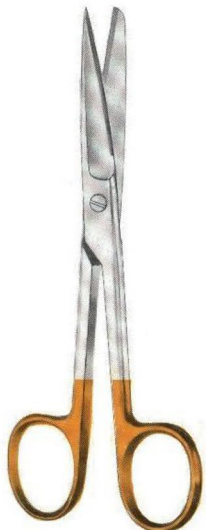
14.5 cm
straight 05-900-14
curved 05-901-14



16.5 cm
05-900-16
05-901-16

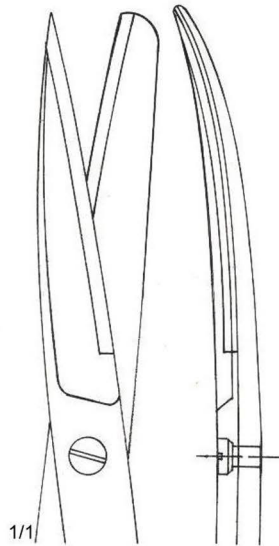
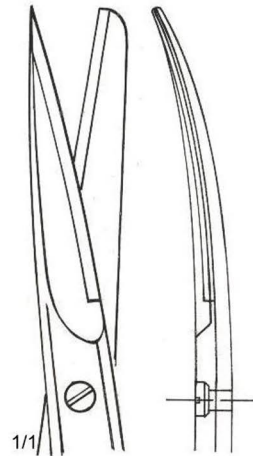


18.5 cm
05-900-18
05-901-18

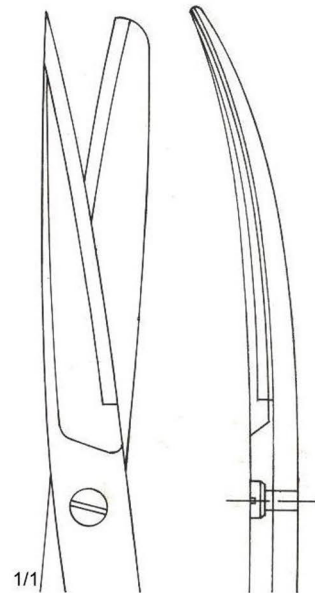


Standard

14.5 cm
straight 05-902-14
curved 05-903-14

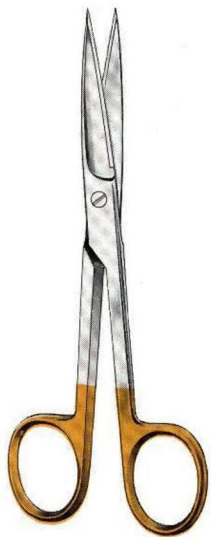


16.5 cm
05-902-16
05-903-16

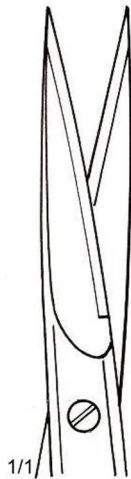


18.5 cm
05-902-18
05-903-18

SCISSORS



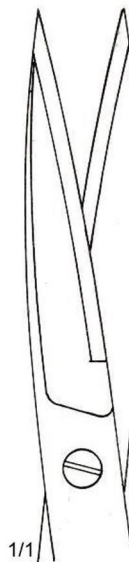
Standard



1/1

14.5 cm

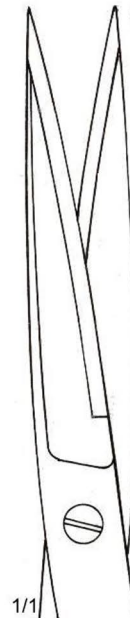
straight 05-904-14
curved 05-905-14



1/1

16.5 cm

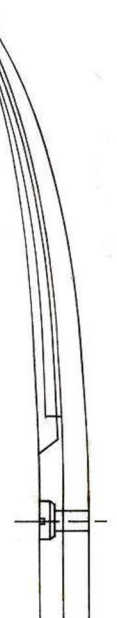
05-904-16
05-905-16



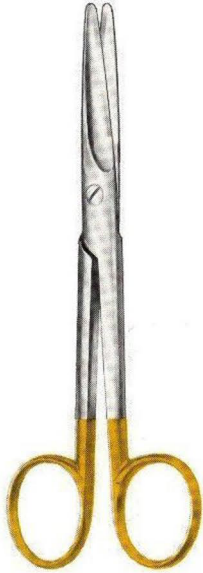
1/1

18.5 cm

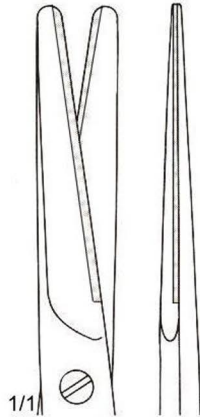
05-904-18
05-905-18



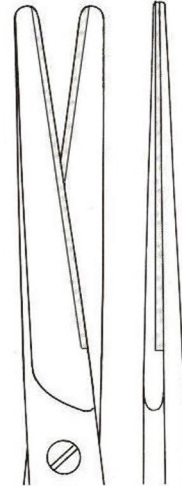
SCISSORS



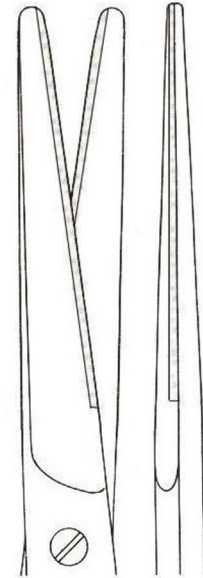
Mayo
05-908-14 - 05-908-23



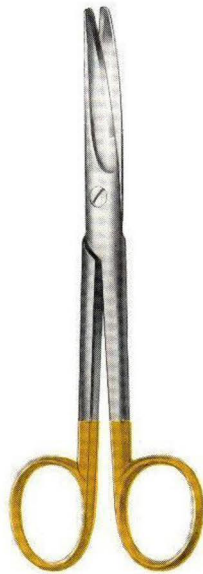
1/1
05-908-14
14.5 cm



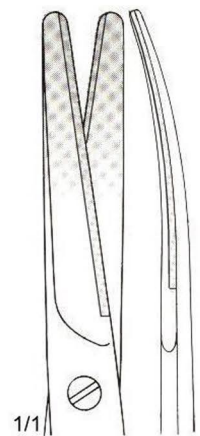
05-908-17
17 cm



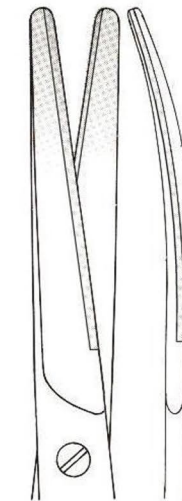
05-908-23
23 cm



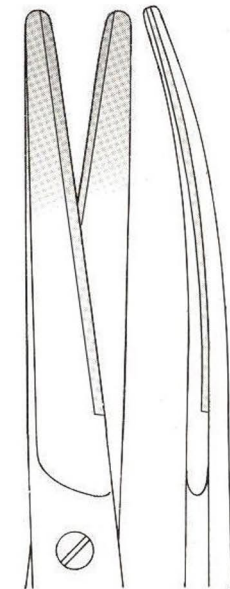
Mayo
05-909-14 - 05-909-23



1/1
05-909-14
14.5 cm

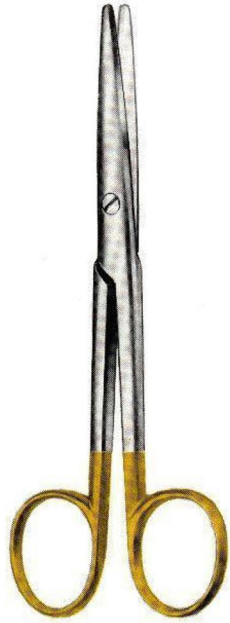


05-909-17
17 cm

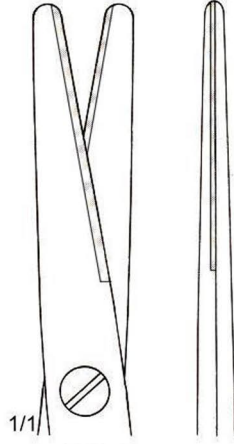


05-909-23
23 cm

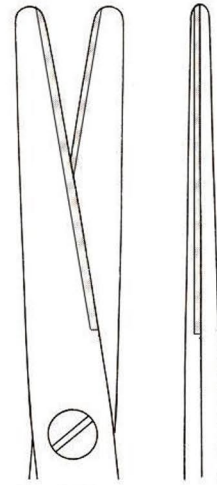
SCISSORS



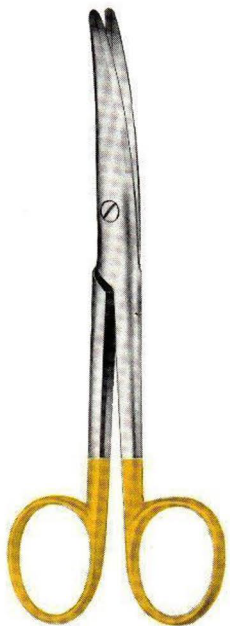
Mayo - Stille
05-910-15 - 05-910-17



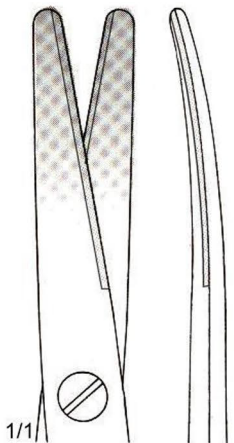
05-910-15
15 cm



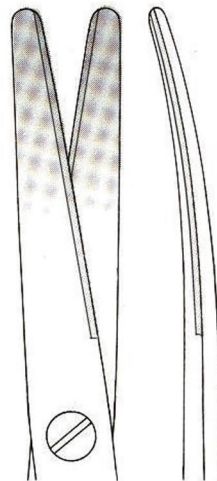
05-910-17
17 cm



Mayo - Stille
05-911-15 - 05-911-17

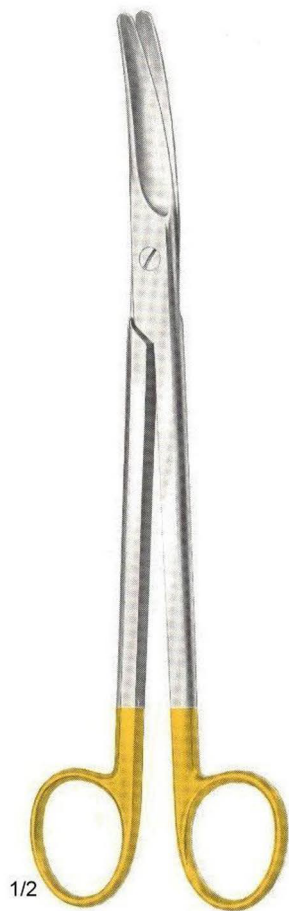


05-911-15
15 cm

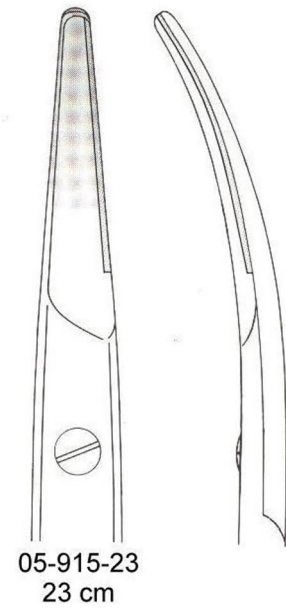
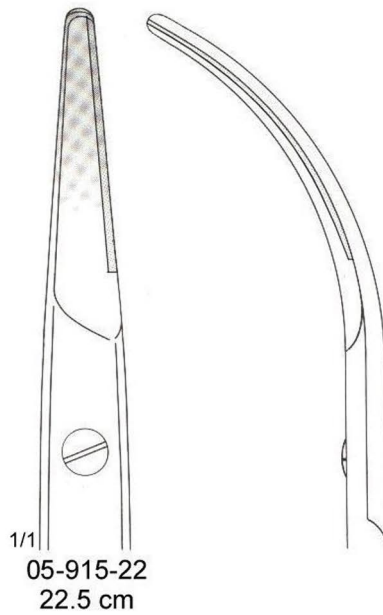


05-911-17
17 cm

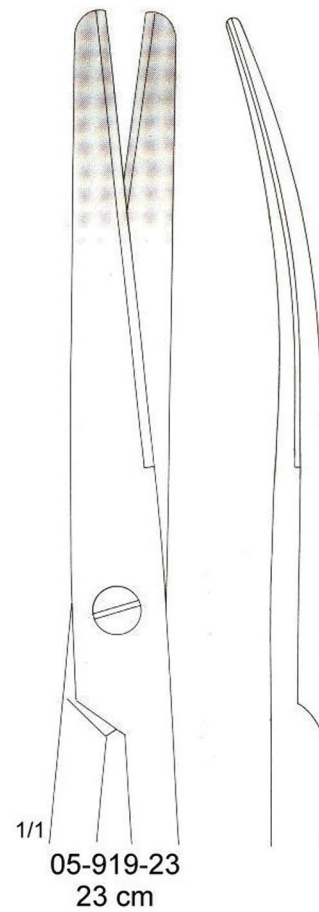
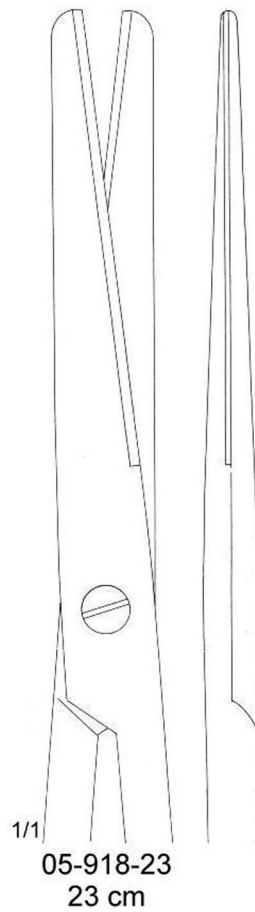
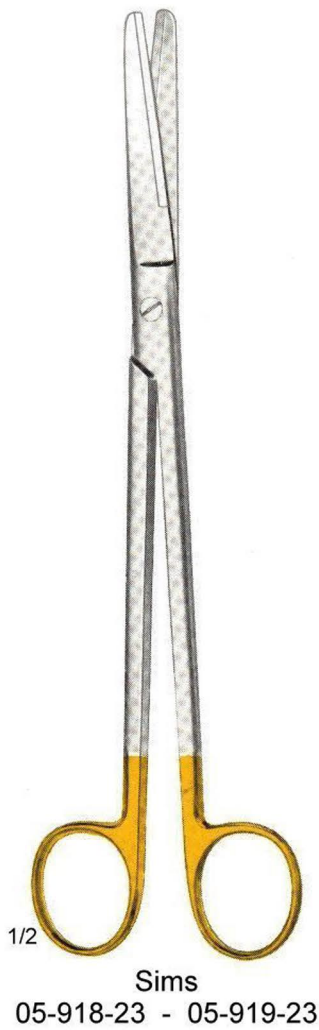
SCISSORS



1/2
Parametrium
05-915-22 - 05-915-23



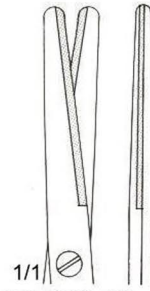
SCISSORS



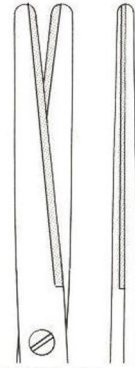
SCISSORS



Metzenbaum
05-920-11 - 05-920-14



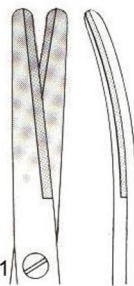
1/1
05-920-11
11.5 cm



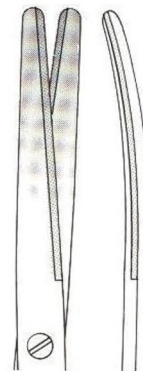
05-920-14
14.5 cm



Metzenbaum
05-921-11 - 05-921-14



1/1
05-921-11
11.5 cm

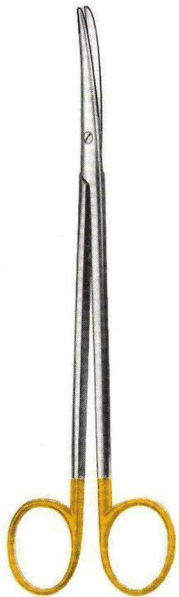
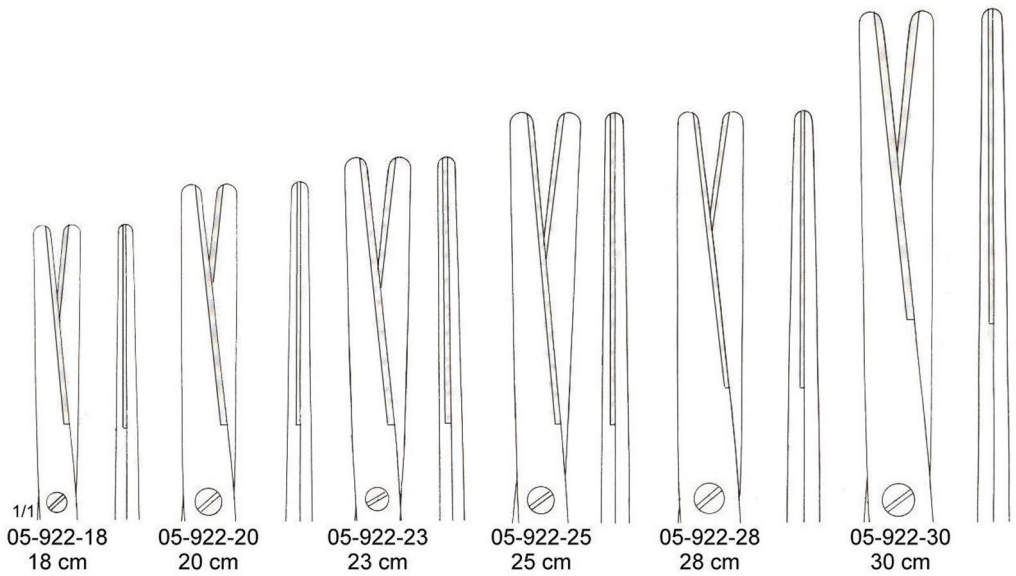


05-921-14
14.5 cm

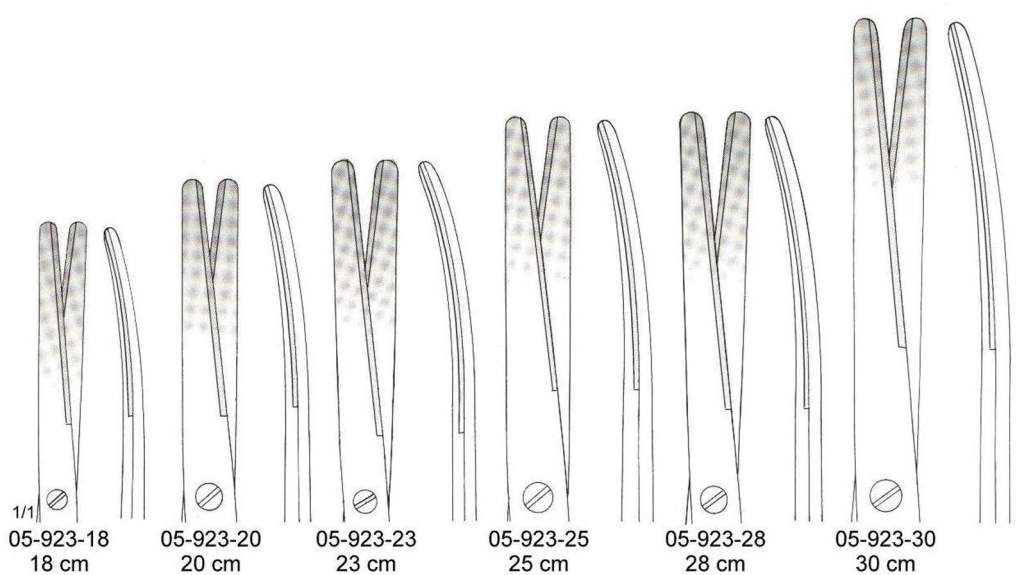
SCISSORS



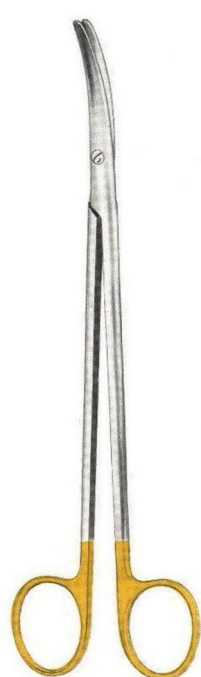
Metzenbaum
05-922-18 - 05-922-30



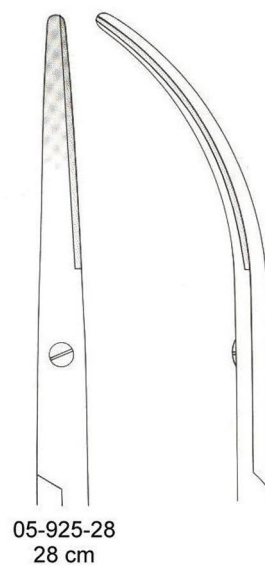
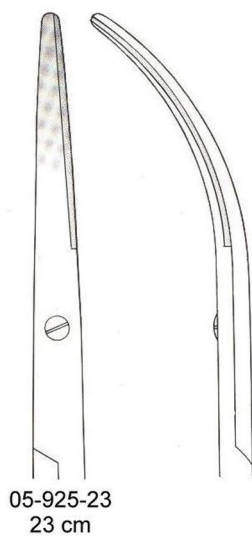
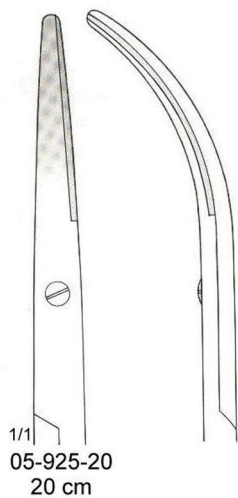
Metzenbaum
05-923-18 - 05-923-30



SCISSORS



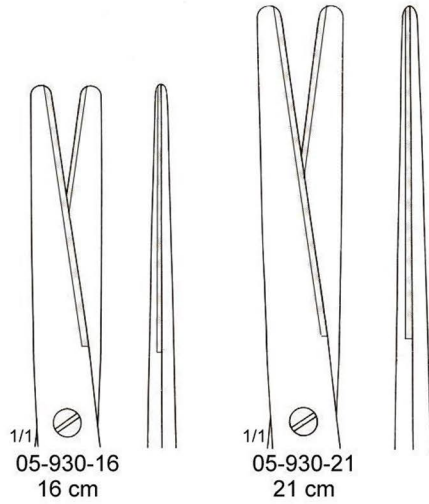
Metzenbaum - Thorek
05-925-20 - 05-925-28



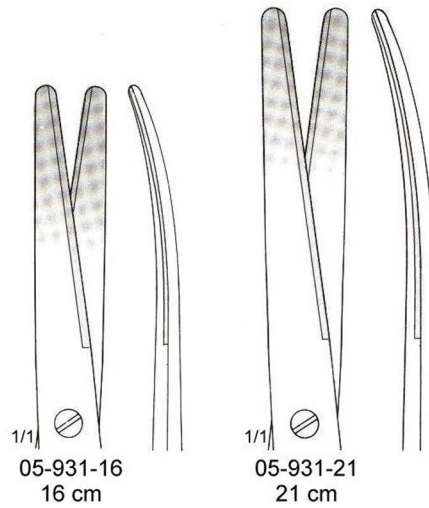
SCISSORS



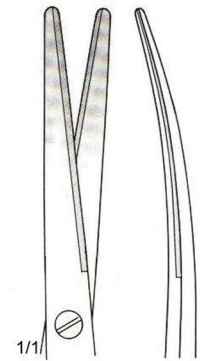
Lexer
05-930-16 - 05-930-21



Lexer
05-931-16 - 05-931-21



Mayo - Lexer
05-933-16
16 cm



SCISSORS

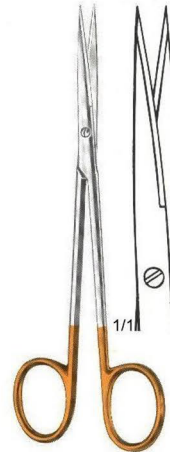


05-936-14
14.5 cm



05-937-14
14.5 cm

Metzenbaum - Fine

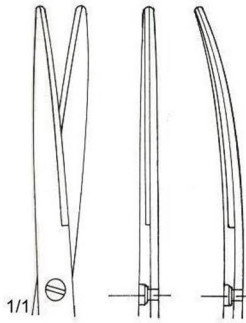


05-938-14
14.5 cm

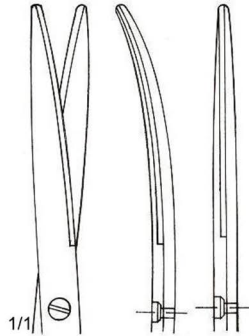


05-939-14
14.5 cm

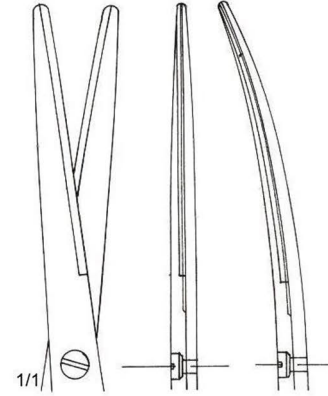
SCISSORS



05-940-18
05-941-18



05-940-20
05-941-20



05-940-23
05-941-23

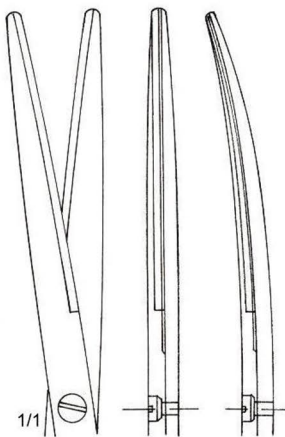


Metzenbaum - Fine

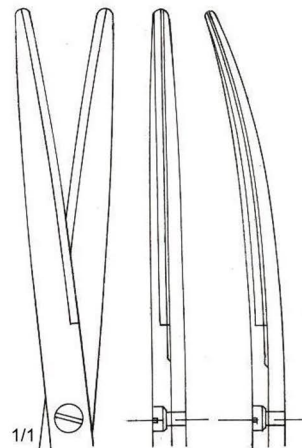
straight

curved

05-940-18	18 cm	05-941-18
05-940-20	20 cm	05-941-20
05-940-23	23 cm	05-941-23
05-940-25	25 cm	05-941-25
05-940-28	28 cm	05-941-28

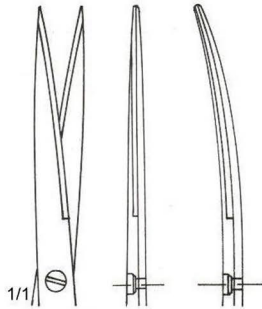


05-940-25
05-941-25

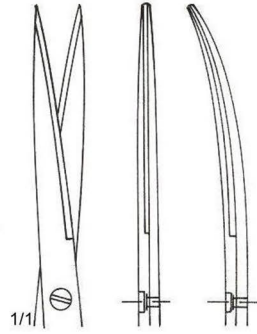


05-940-28
05-941-28

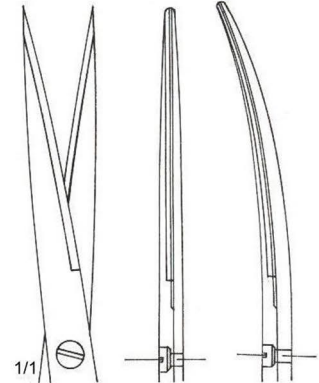
SCISSORS



05-942-18
05-943-18



05-942-20
05-943-20

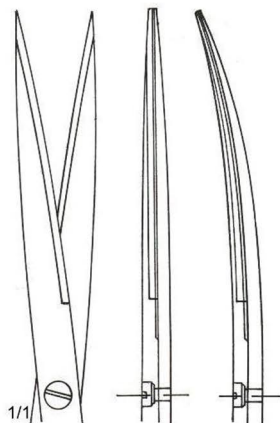


05-942-23
05-943-23

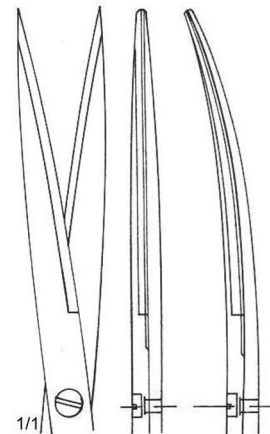


Metzenbaum - Fine

straight	curved
05-942-18 18 cm	05-943-18
05-942-20 20 cm	05-943-20
05-942-23 23 cm	05-943-23
05-942-25 25 cm	05-943-25
05-942-28 28 cm	05-943-28

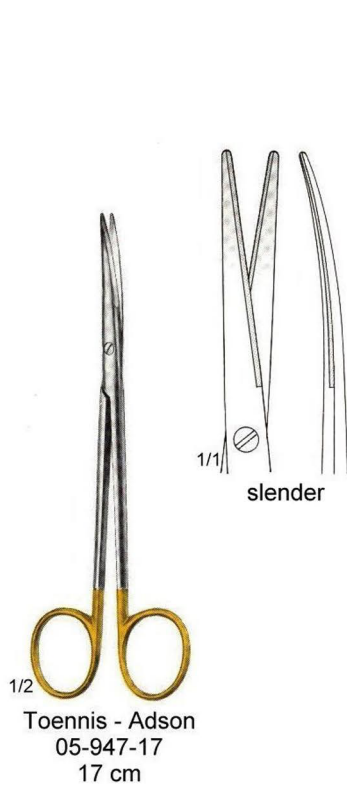
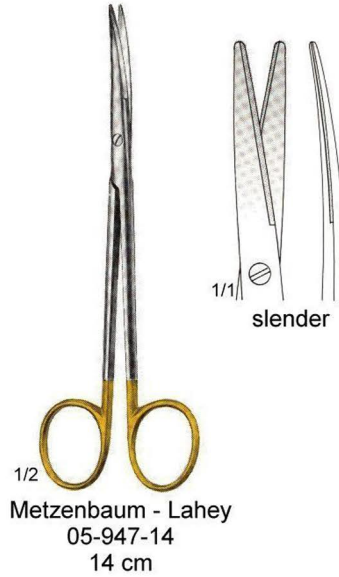


05-942-25
05-943-25

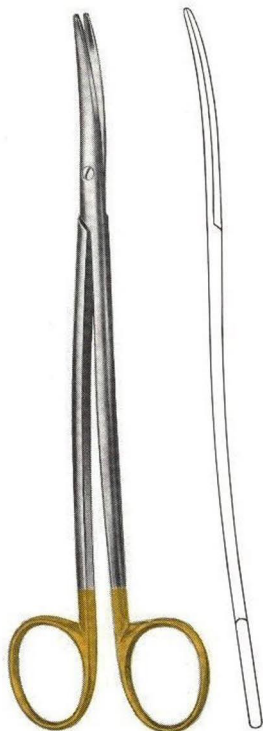


05-942-28
05-943-28

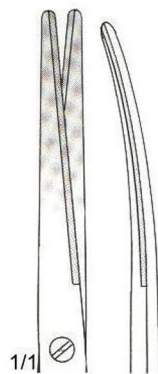
SCISSORS



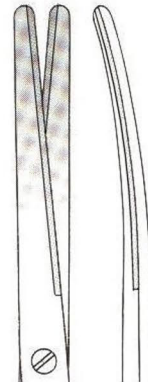
SCISSORS



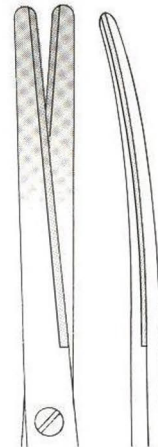
Metzenbaum - Fine
05-949-18 - 05-949-23
S-shaped



05-949-18
18 cm

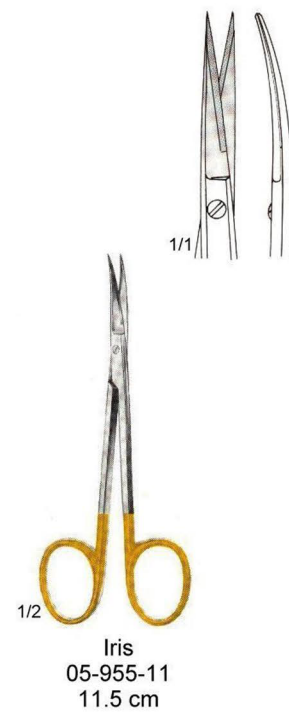
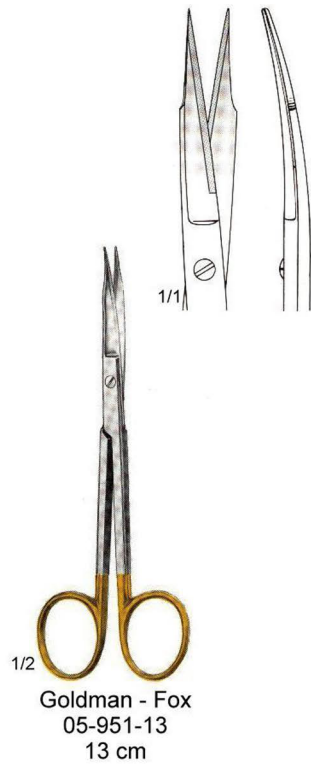
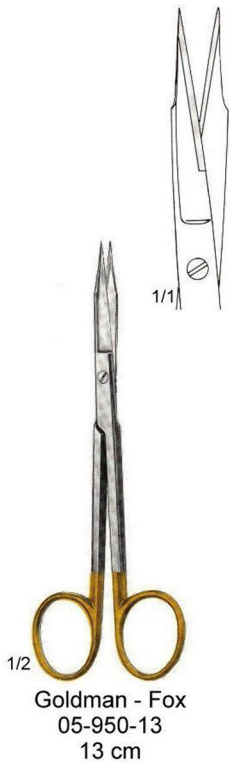


05-949-20
20 cm

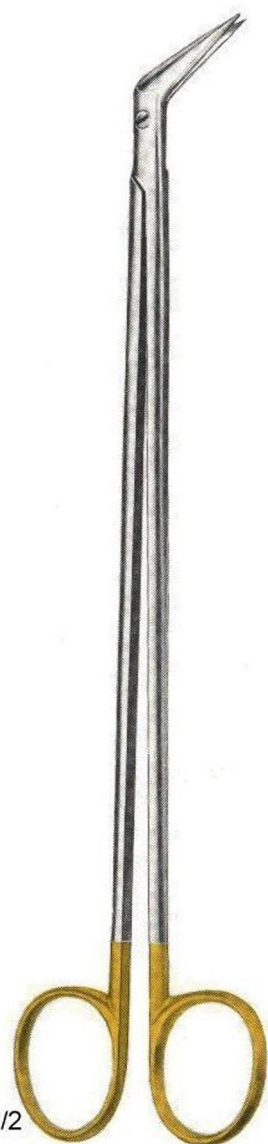


05-949-23
23 cm

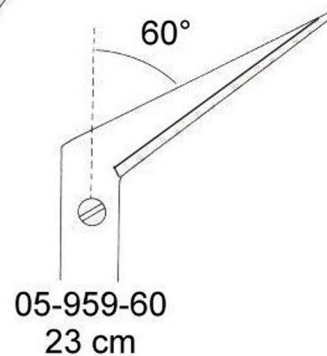
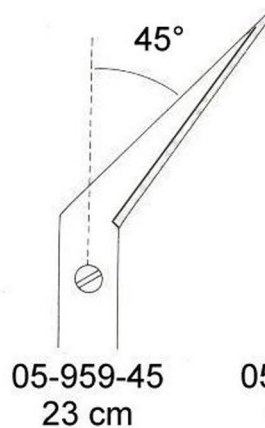
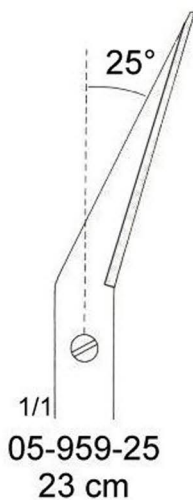
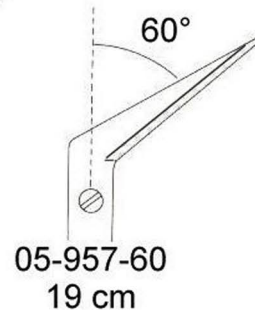
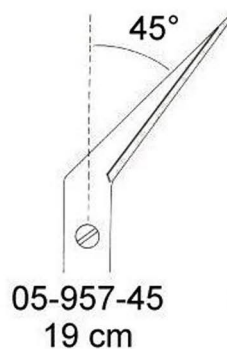
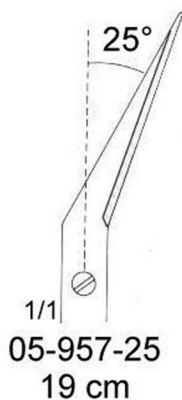
SCISSORS



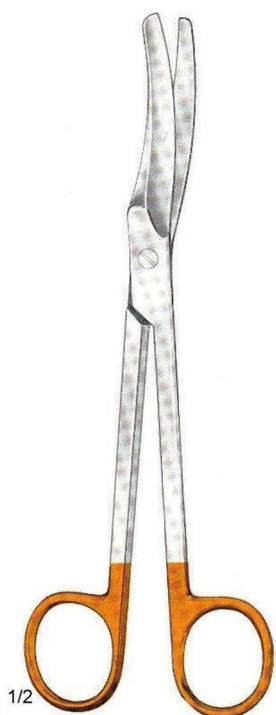
SCISSORS



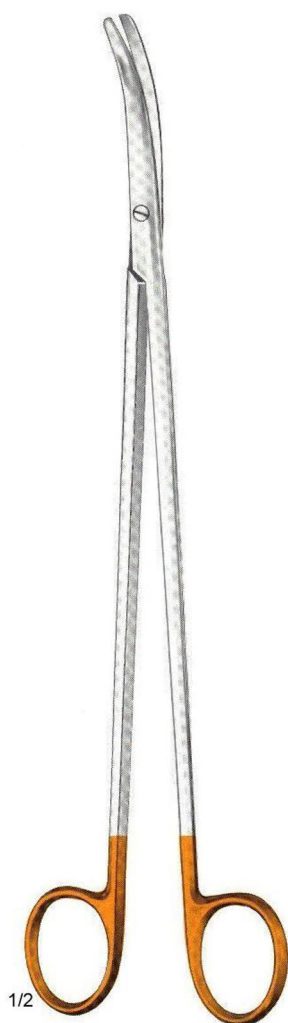
1/2
De Bakey
(Potts - Smith)
05-957-25 - 05-959-60



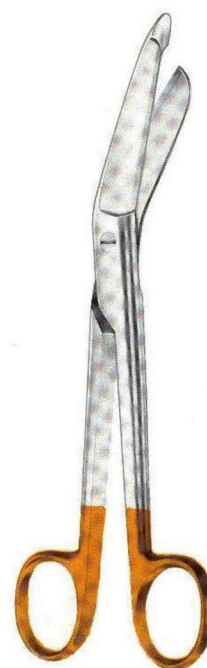
SCISSORS



05-960-20
20 cm

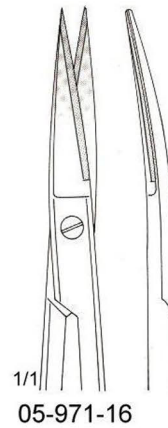
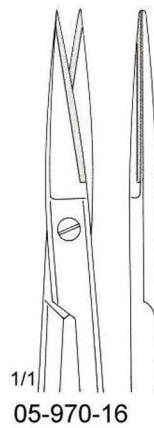


Cardinale
05-962-28
28 cm



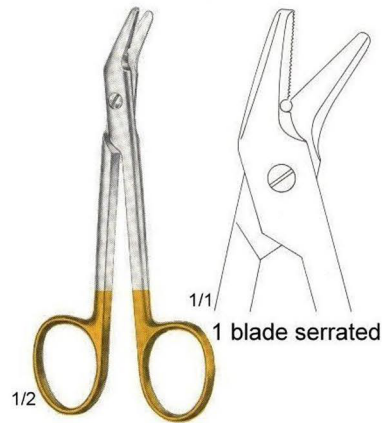
Lister
05-964-14 14 cm
05-964-16 16 cm
05-964-18 18 cm
05-964-20 20 cm

SCISSORS

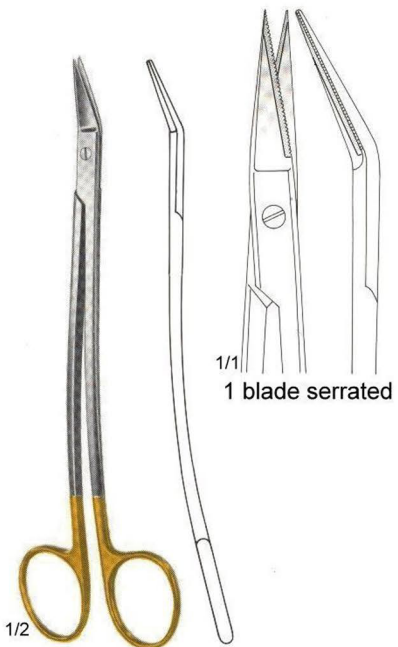


SCISSORS

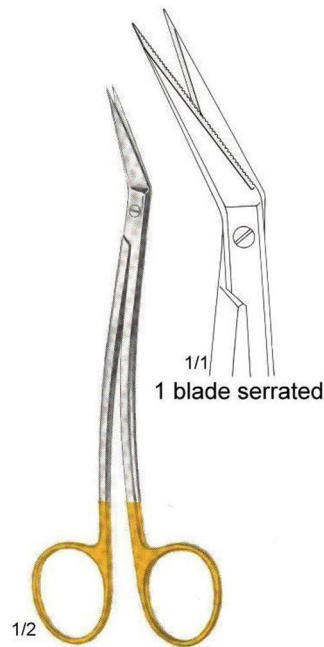
wire cutting



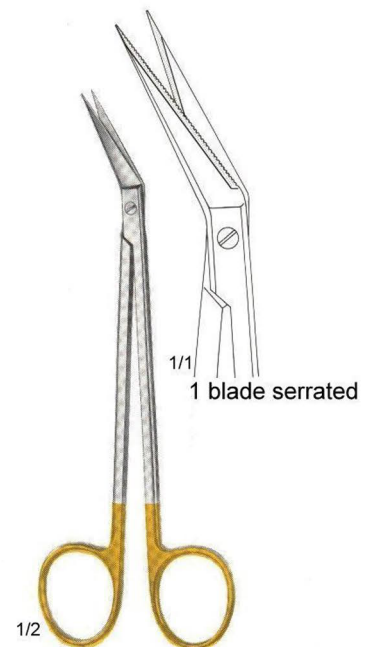
Universal
05-974-12
12 cm



Dean
05-976-17
17 cm

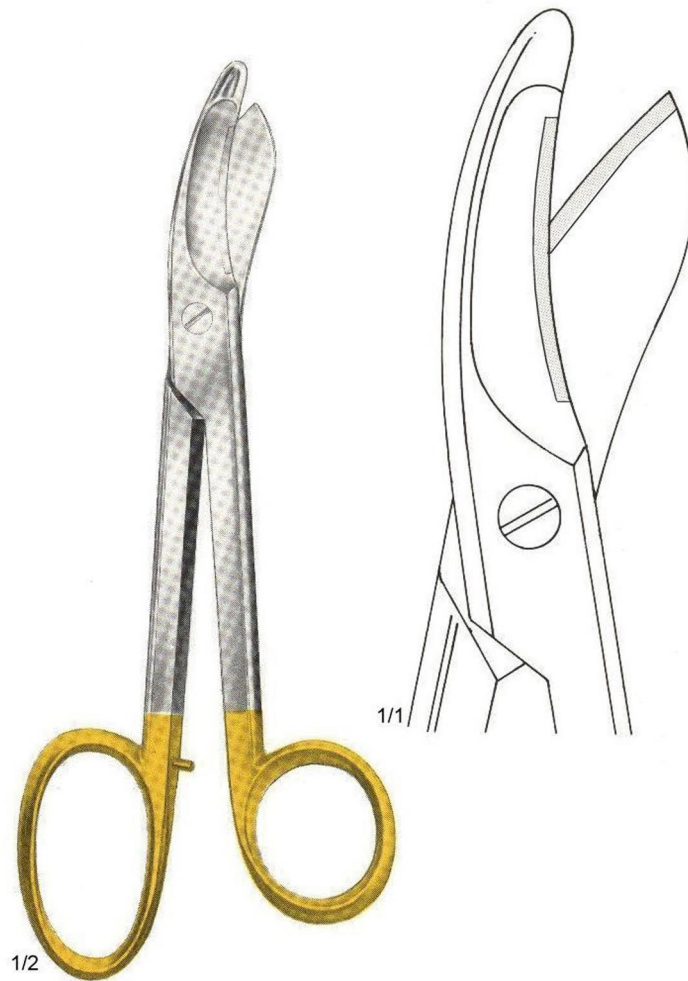


Locklin
05-977-16
16 cm



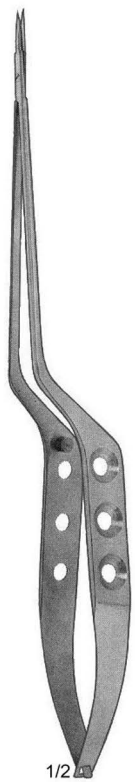
Locklin
05-978-16
16 cm

SCISSORS

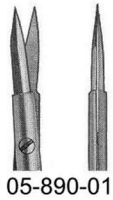


Bruns
05-980-24
24 cm

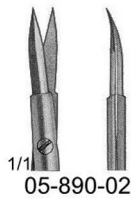
SCISSORS



1/2
Vannas - Yasargil
05-890-01 - 05-890-02
22.5 cm



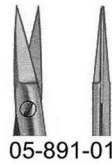
05-890-01



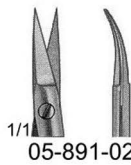
1/1
05-890-02



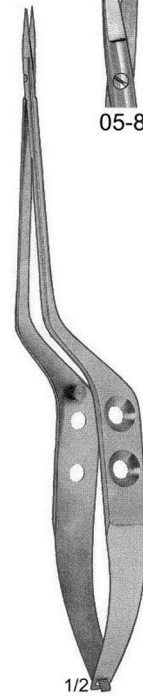
1/2
Yasargil
05-891-01 - 05-891-02
16.5 cm



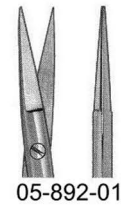
05-891-01



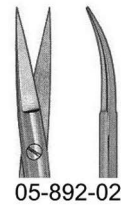
1/1
05-891-02



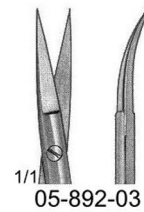
1/2
Yasargil
05-892-01 - 05-892-03
20 cm



05-892-01



05-892-02



1/1
05-892-03

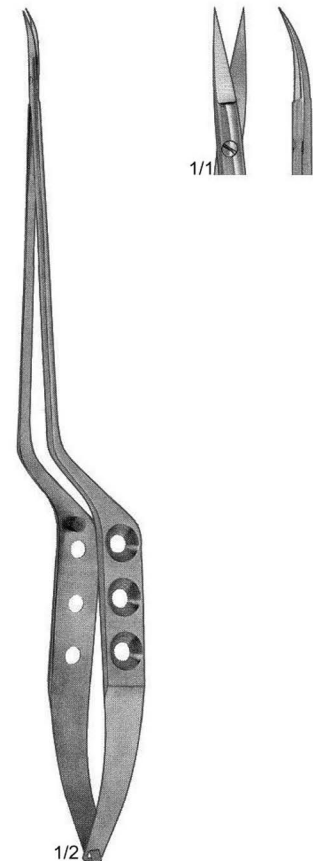
SCISSORS



1/2
Yasargil
05-893-01 - 05-893-02
22.5 cm

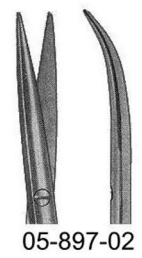
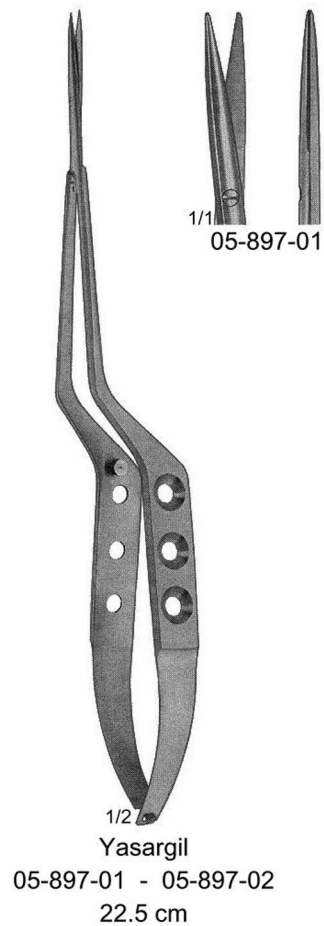
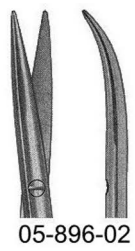
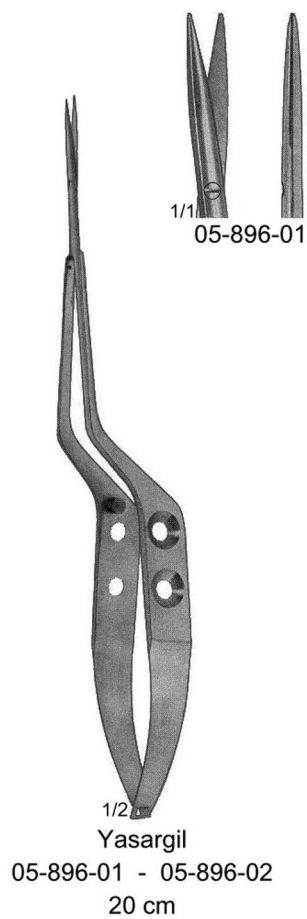


1/2
Yasargil
05-894-01
22.5 cm



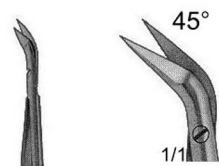
1/2
Yasargil
05-895-01
24.5 cm

SCISSORS

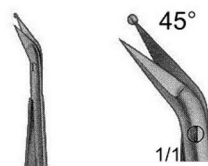


SCISSORS

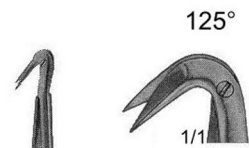
Angled On Side



1/2
Nagel
05-898-01
19.5 cm

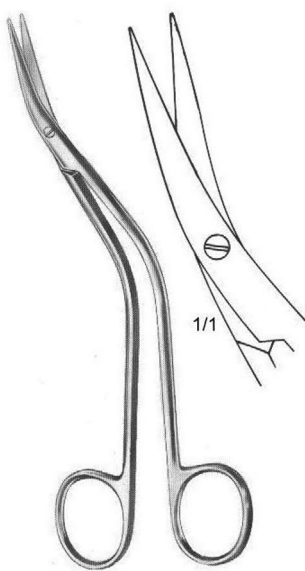


1/2
05-898-02
19.5 cm

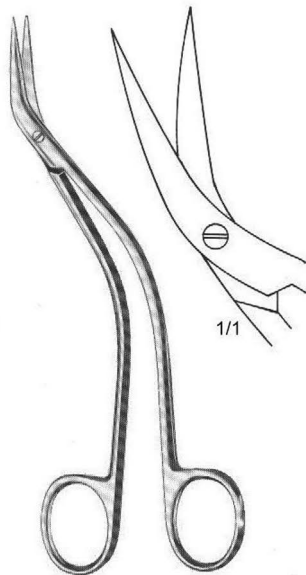


1/2
05-899-01
18.5 cm

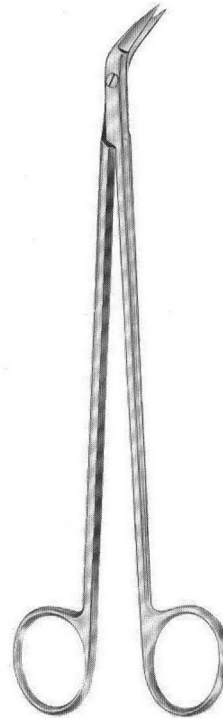
SCISSORS



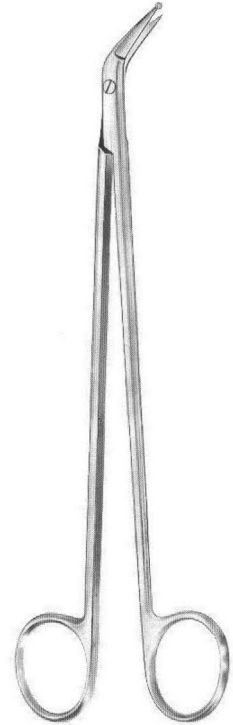
De Bakey
05-440-15
15.5 cm



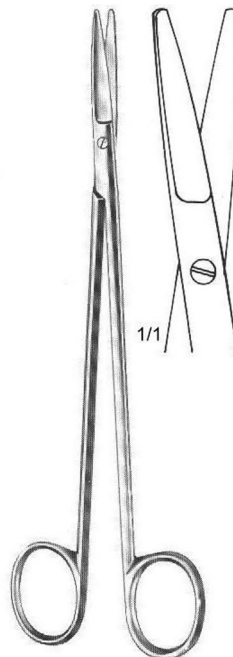
De Bakey
05-441-15
15.5 cm



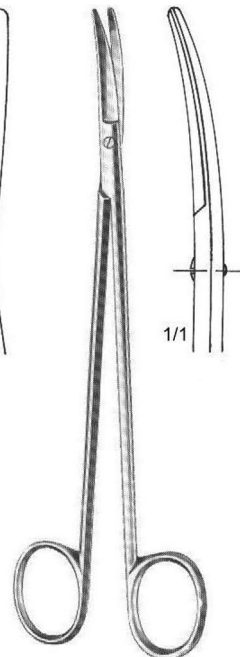
Potts - De Martel
05-442-21
21 cm



Mills
05-444-21
21 cm



Toennis
05-446-18
18 cm



Toennis
05-447-18
18 cm



CONTACT US

 +62 856-6381-381

 inquiry@averonindonesia.com

 sales@averonindonesia.com

 www.averonindonesia.com

 Axa tower - Kuningan City Lt 45-7A Jl Prof. DR. Satrio, Kuningan, Kecamatan Setiabudi, Kota Jakarta Selatan, Daerah Khusus Ibukota Jakarta 12940.