



**PT.AVERON**  
— GLOBAL INDONESIA —  
IMPORTER & SUPPLIER OF MEDICAL INSTRUMENTS



**Micro  
Surgery**

 [www.averonindonesia.com](http://www.averonindonesia.com)

# MICRO SURGERY



# MICRO SURGERY

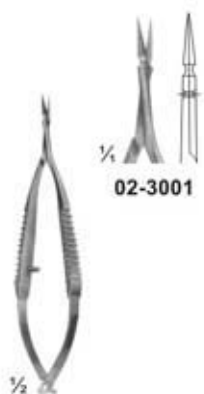

02-3001



02-3002



02-3003



02-3004  
angled to side



02-3005



02-3006  
NOYES  
Size: 125 mm

02-3001 - 02-3003  
VANNAS  
Size: 85 mm

02-3004 - 02-3005  
CASTROVIEJO  
Size: 95 mm

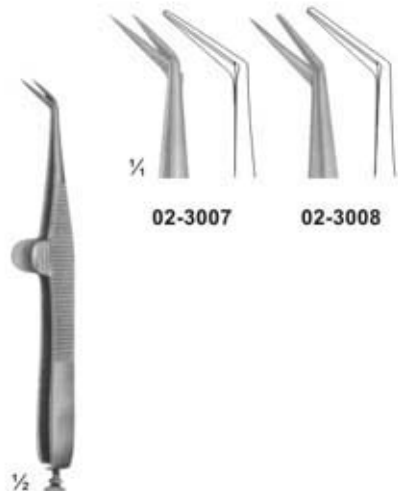

02-3007



02-3008

02-3007 - 02-3008  
WECKER  
Eye Scissor  
Size: 110 mm

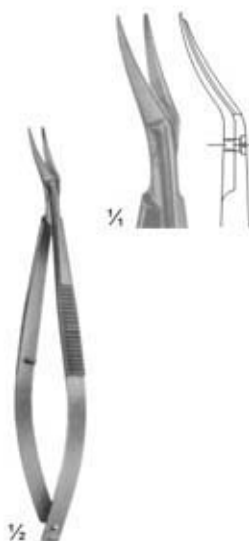

02-3009  
CASTROVIEJO  
Eye Scissor  
Size: 115 mm

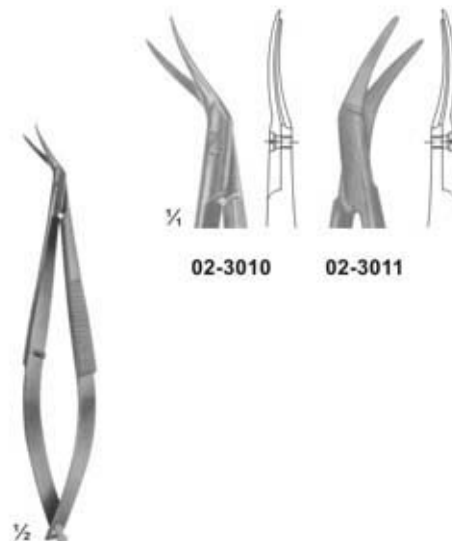

02-3010



02-3011

02-3010 - 02-3011  
CASTROVIEJO  
Eye Scissor  
Size: 110 mm

# MICRO SURGERY

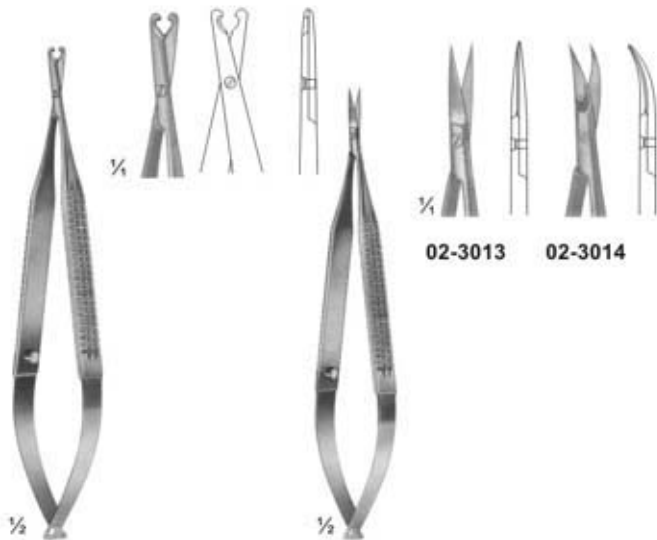

**02-3012**  
BIEMER  
Vein Scissor  
Size: 130 mm

**02-3013 - 02-3014**  
Size: 120 mm

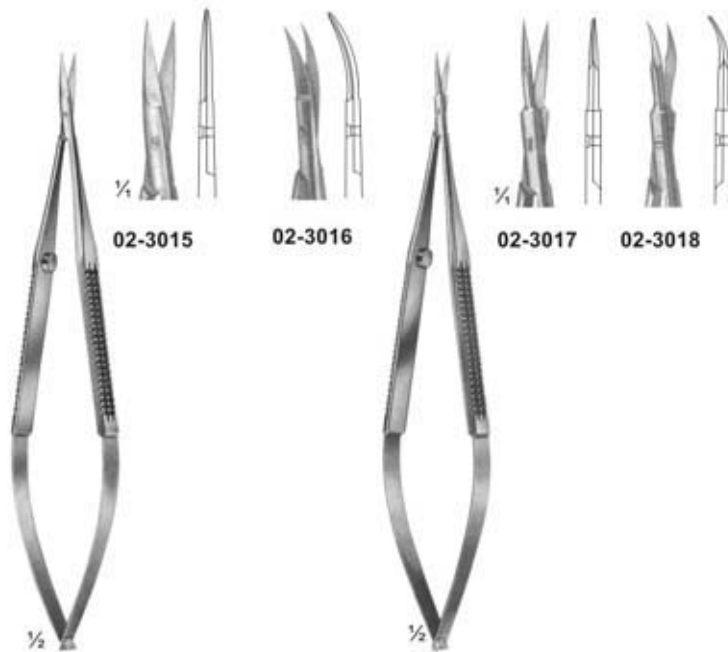

**02-3015 - 02-3016**  
Size: 160 mm

**023017 - 02-3018**  
VANNAS  
Size: 160 mm



**02-3019**  
CASPAR  
Micro Scissor Curved

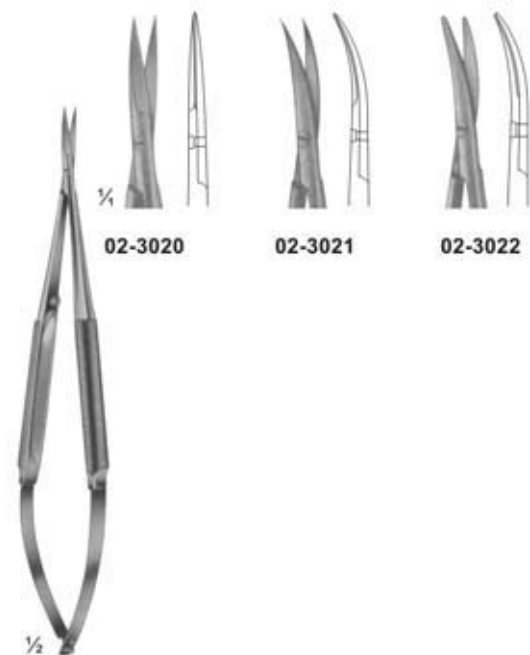

**02-3020 - 02-3022**  
Micro Dissecting Scissor  
Size: 145 mm

# MICRO SURGERY



**02-3023**  
YASARGIL  
Size: 245 mm



**02-3024**  
45°  
Nagel



**02-3025**  
45°



125°

**02-3024 - 02-3025**  
Laterally Angled  
Size: 200 mm



**02-3026**  
Laterally Angled  
Size: 190 mm

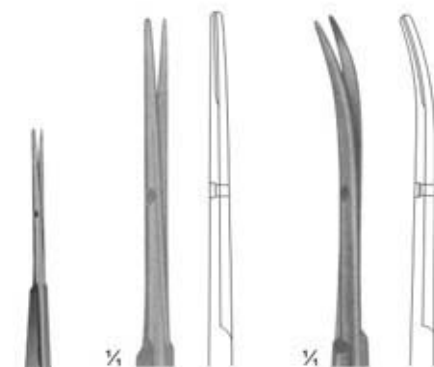

**02-3027**

**02-3028**



**02-3027 - 02-3028**  
YASARGIL  
Size: 225 mm

# MICRO SURGERY

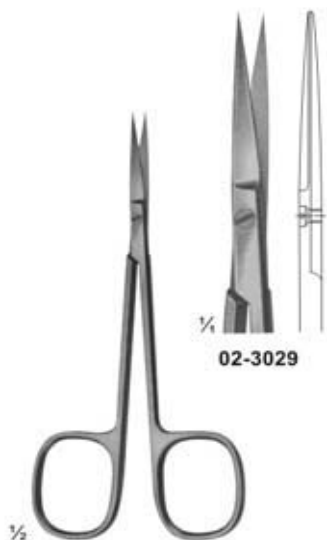

1/4  
**02-3029**



**02-3030**

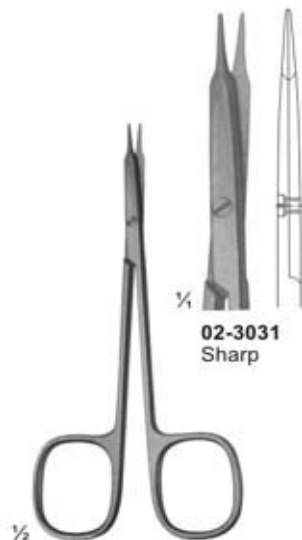

1/4  
**02-3031**  
Sharp



**02-3032**  
Sharp



**02-3033**  
Blunt



**02-3034**  
Blunt

**02-3029-02-3030**  
Size: 120 mm

**02-3031 - 02-3034**  
STEVENS  
Dissecting Scissors  
Size: 115 mm

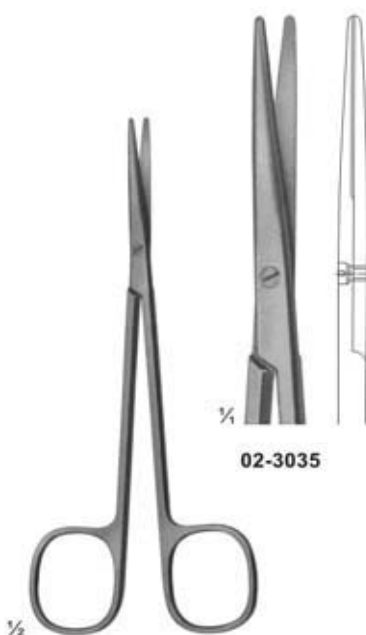

1/4  
**02-3035**



**02-3036**

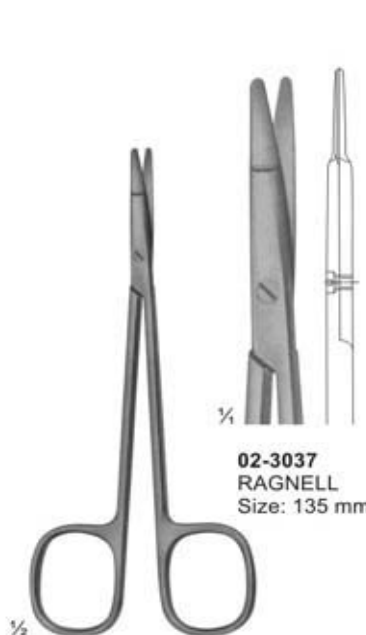

1/4  
**02-3037**  
RAGNELL  
Size: 135 mm

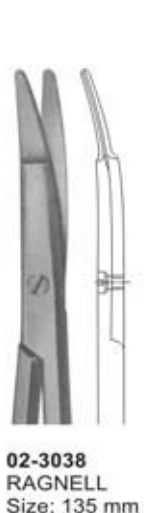

**02-3038**  
RAGNELL  
Size: 135 mm



**02-3039**  
Size: 150 mm

**02-3035 - 02-3036**  
METZENBAUM  
Dissecting Scissors  
Size: 145 mm

**02-3037 - 02-3039**  
Special flat points for  
dissecting and  
undermining the skin

# MICRO SURGERY



02-3040

02-3041

02-3040 - 02-3041  
Size: 90 mm



02-3042

02-3043

02-3042 - 02-3043  
Size: 95 mm



02-3044

02-3045

02-3044 - 02-3045  
Size: 105 mm



02-3046

02-3047

02-3046 - 02-3047  
Size: 120 mm

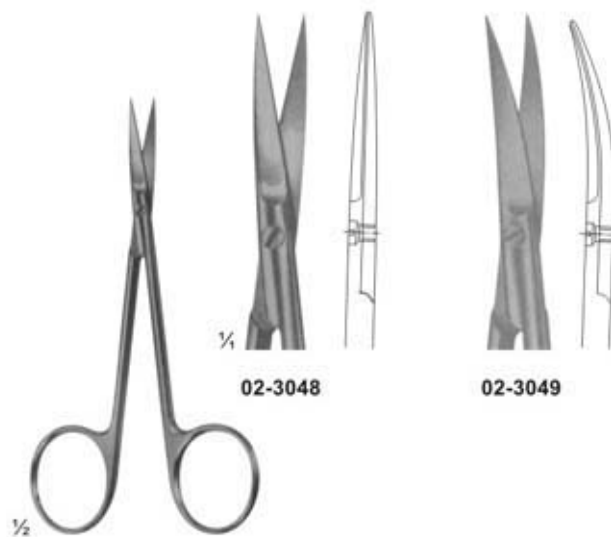

02-3048

02-3049

02-3048 - 02-3049  
Size: 115 mm

# MICRO SURGERY



**02-3050 - 02-3052**  
Size: 120 mm

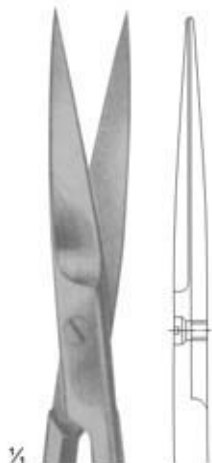

**02-3050**

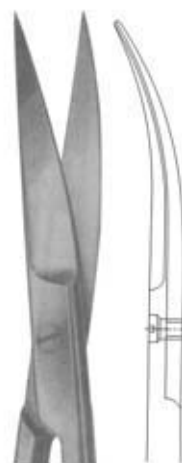

**02-3051**

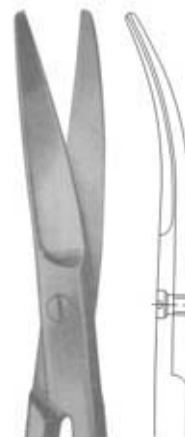

**02-3052**



**02-3053 - 02-3056**  
Size: 130 mm



**02-3053**

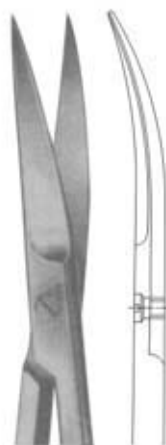

**02-3054**

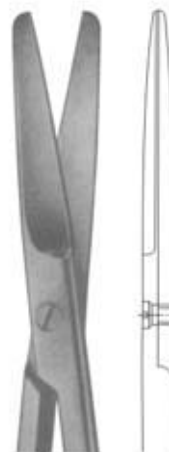

**02-3055**



**02-3056**

# MICRO SURGERY

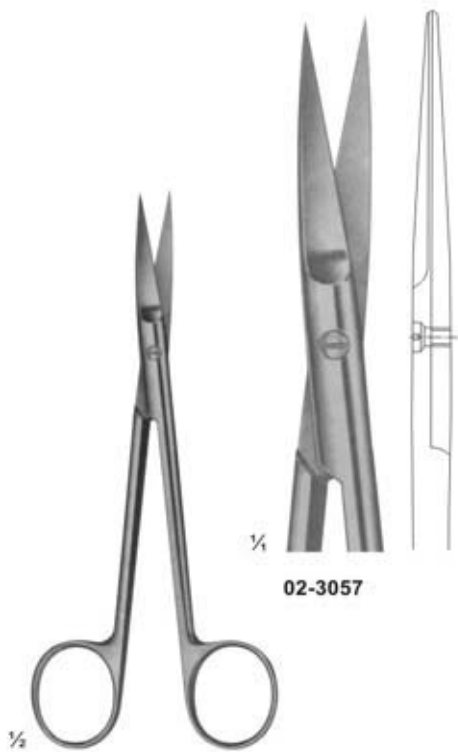

02-3057



02-3058

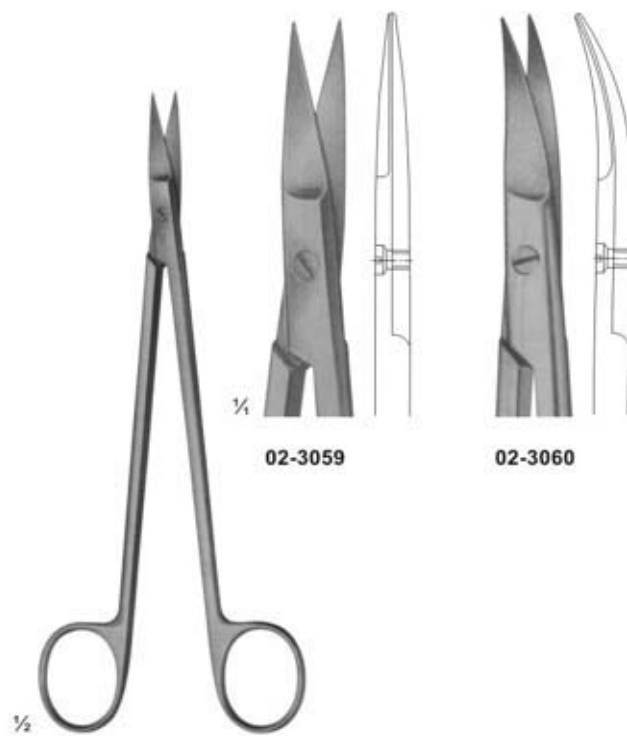

02-3059

02-3060

**02-3057 - 02-3058**  
JOSEPH  
Size: 150 mm

**02-3059 - 02-3060**  
KELLY  
Size: 175 mm

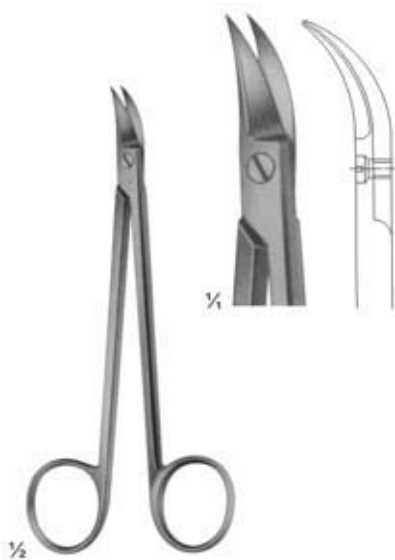

**02-3061**  
QUINBY  
Size: 130 mm

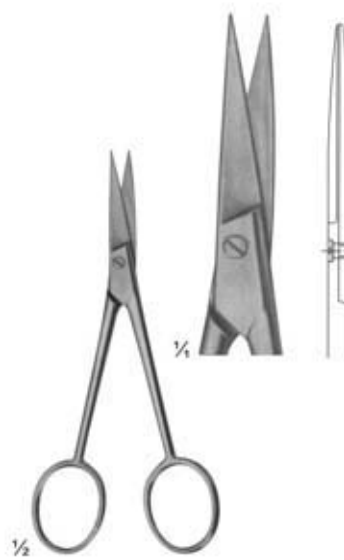

**02-3062**  
Size: 110 mm

# MICRO SURGERY

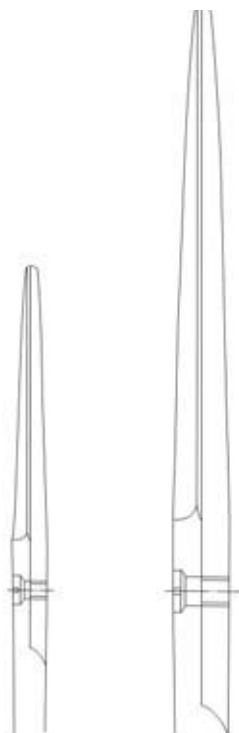

**02-3063 - 02-3071 (Standard Types)**  
**02-3063** ( 105 mm )  
**02-3064** ( 115 mm )  
**02-3065** ( 130 mm )  
**02-3066** ( 145 mm )  
**02-3067** ( 150 mm )  
**02-3068** ( 165 mm )  
**02-3069** ( 175 mm )  
**02-3070** ( 185 mm )  
**02-3071** ( 200 mm )

**02-3063**  
Size: 105 mm

**02-3071**  
Size: 200 mm

**02-3072 - 02-3078 (Standard Types)**  
**02-3072** ( 115 mm )  
**02-3073** ( 130 mm )  
**02-3074** ( 145 mm )  
**02-3075** ( 150 mm )  
**02-3076** ( 165 mm )  
**02-3077** ( 175 mm )  
**02-3078** ( 185 mm )

**02-3072**  
Size: 115 mm

**02-3078**  
Size: 185 mm

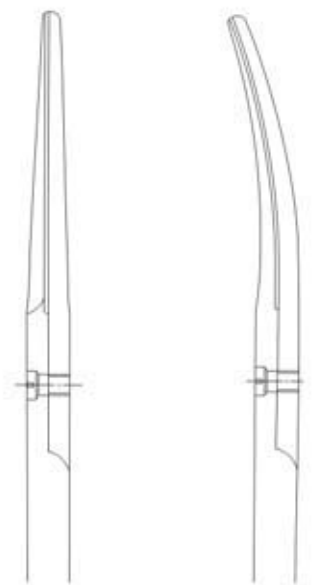
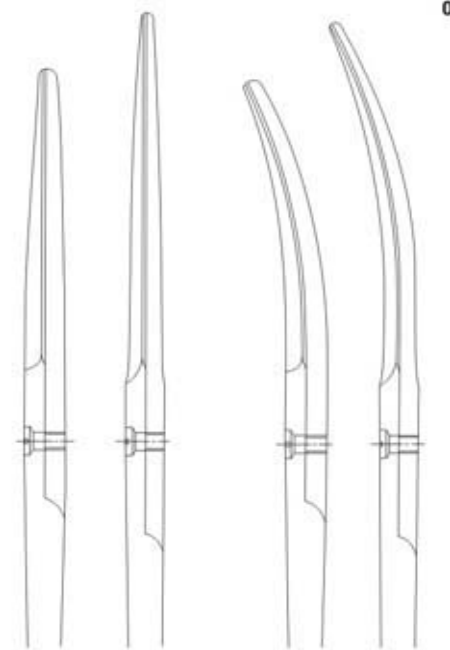

**02-3079 - 02-3082**  
Slender Types

**02-3079** 130 mm  
**02-3080** 145 mm

**02-3081** 130 mm  
**02-3082** 145 mm

**02-3083 - 02-3084**  
For Wound Edges  
1 Blade Serrated

**02-3083**  
130 mm

**02-3084**  
130 mm

# MICRO SURGERY



1/2



**02-3085**  
Size: 130 mm



**02-3089**  
Size: 175 mm



1/2



**02-3090**  
Size: 115 mm



**02-3095**  
Size: 175 mm

- 02-3085 - 02-3089 (Standard Types)**  
**02-3085** ( 130 mm )  
**02-3086** ( 145 mm )  
**02-3087** ( 150 mm )  
**02-3088** ( 165 mm )  
**02-3089** ( 175 mm )

- 02-3090 - 02-3095 - COOPER**  
**Standard Types**  
**02-3090** ( 115 mm )  
**02-3091** ( 130 mm )  
**02-3092** ( 145 mm )  
**02-3093** ( 150 mm )  
**02-3094** ( 165 mm )  
**02-3095** ( 175 mm )



1/2



**02-3096**  
Size: 115 mm



**02-3100**  
Size: 165 mm



**02-3100A**  
Size: 115 mm



**02-3102A**  
Size: 165 mm

- 02-3096 - 02-3102A**  
**Standard Types**  
**02-3096** ( 115 mm )    **02-3100A** ( 115 mm )  
**02-3097** ( 130 mm )    **02-3101** ( 130 mm )  
**02-3098** ( 145 mm )    **02-3101A** ( 145 mm )  
**02-3099** ( 150 mm )    **02-3102** ( 150 mm )  
**02-3100** ( 165 mm )    **02-3102A** ( 165 mm )

# MICRO SURGERY

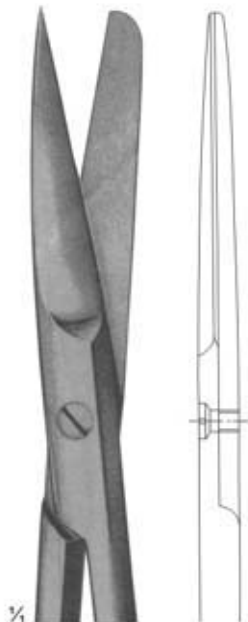

**02-3103**  
Size: 145 mm

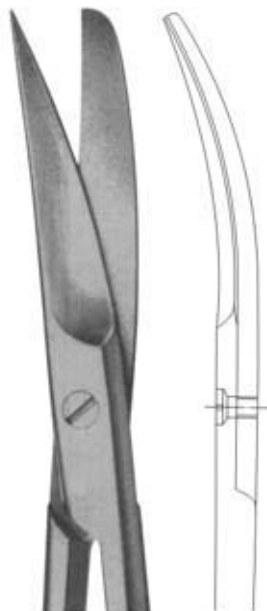

**02-3104**  
Size: 145 mm

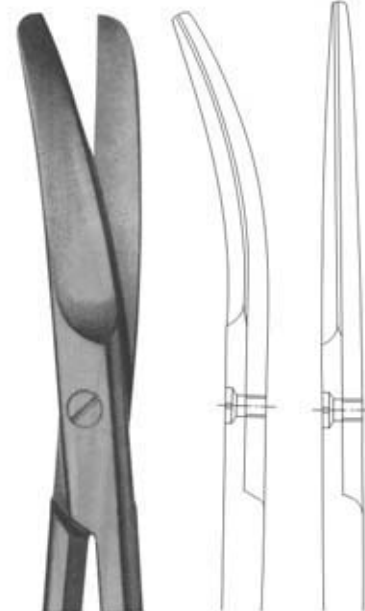

**02-3105**  
Size: 145 mm



**02-3106**  
Size: 145 mm

**02-3103 - 02-3106**  
DEAVER  
With flat lock



**02-3107**  
Size: 130 mm

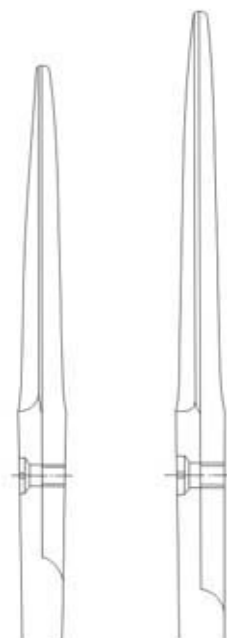

**02-3108**  
Size: 145 mm

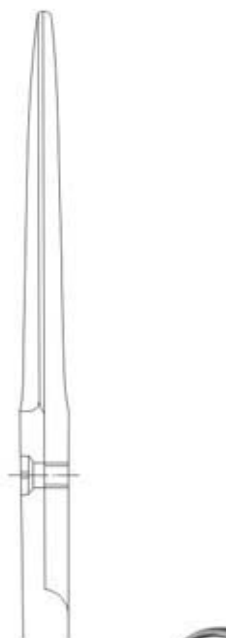

**02-3109**  
Size: 165 mm



**02-3110**  
SYSTRUNK  
Nail Splitting Scissors



**02-3110**  
Size: 130 mm

**02-3107 - 02-3109**  
Incision Scissors

# MICRO SURGERY



**02-3120**  
Size: 125 mm

**02-3121**  
Size: 150 mm

145 mm 175 mm

**02-3120 - 02-3121**  
**KILNER**  
Special flat points for dissecting and undermining the skin

**02-3122**  
**KILNER**  
Fine dissecting scissors  
Size: 115 mm

**02-3123**  
**JAMESON**  
Dissecting scissors  
Size: 150 mm

**02-3124**  
**REYNOLDS**  
Dissecting scissors

**02-3125**  
**DE BAKEY**  
Ateriotomy scissors  
Size: 175 mm

**02-3126 - 02-3127**  
**TOENNIS - ADSON**  
Dissecting scissors  
Size: 175 mm

**02-3128 - 02-3130**  
**TOENNIS**  
Dissecting scissors  
Size: 180 mm

**02-3126**  
Very delicate

**02-3127**  
Delicate

**02-3128**  
Very delicate

**02-3129**  
Delicate

**02-3130**  
Delicate

# MICRO SURGERY

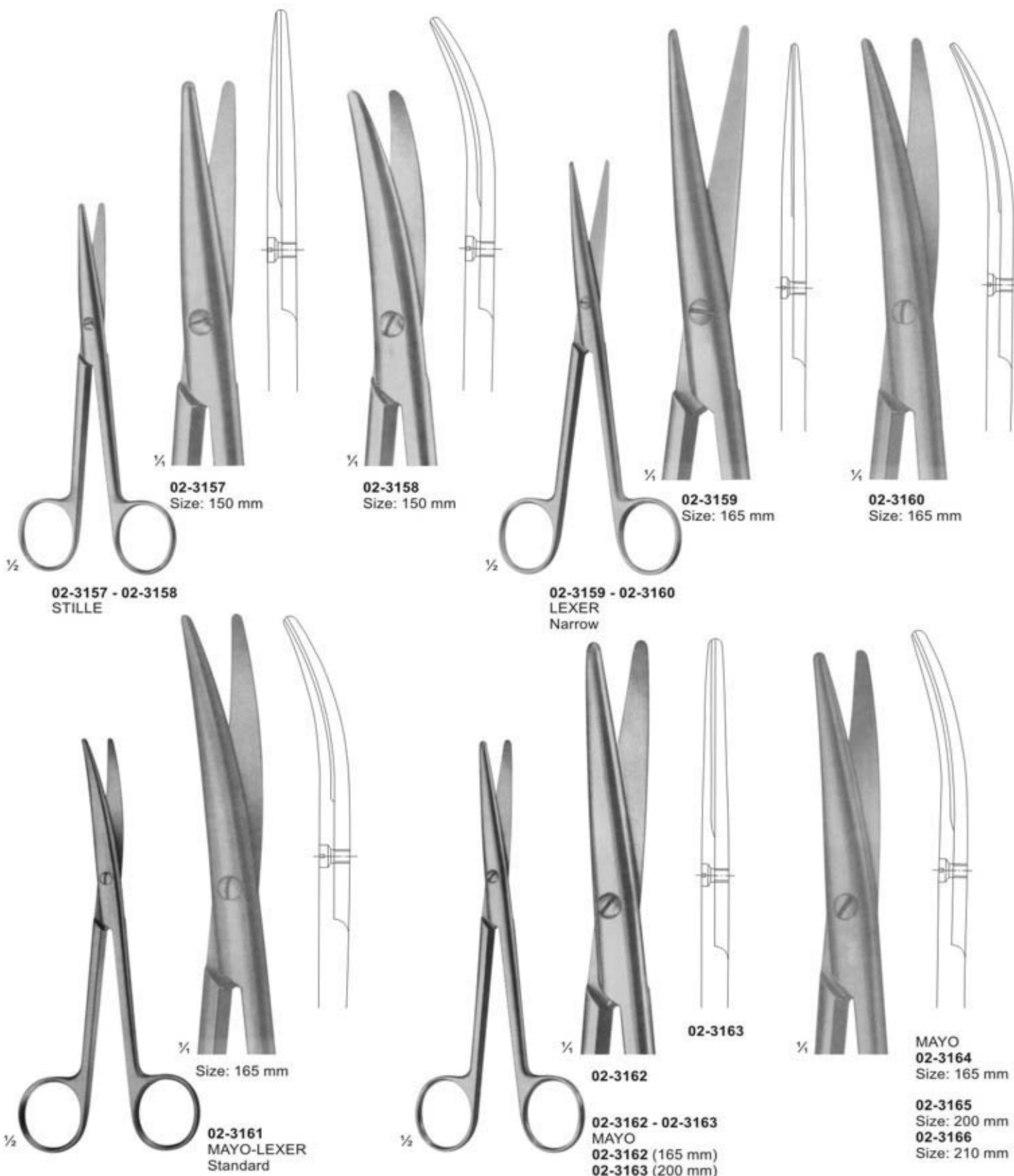

# MICRO SURGERY

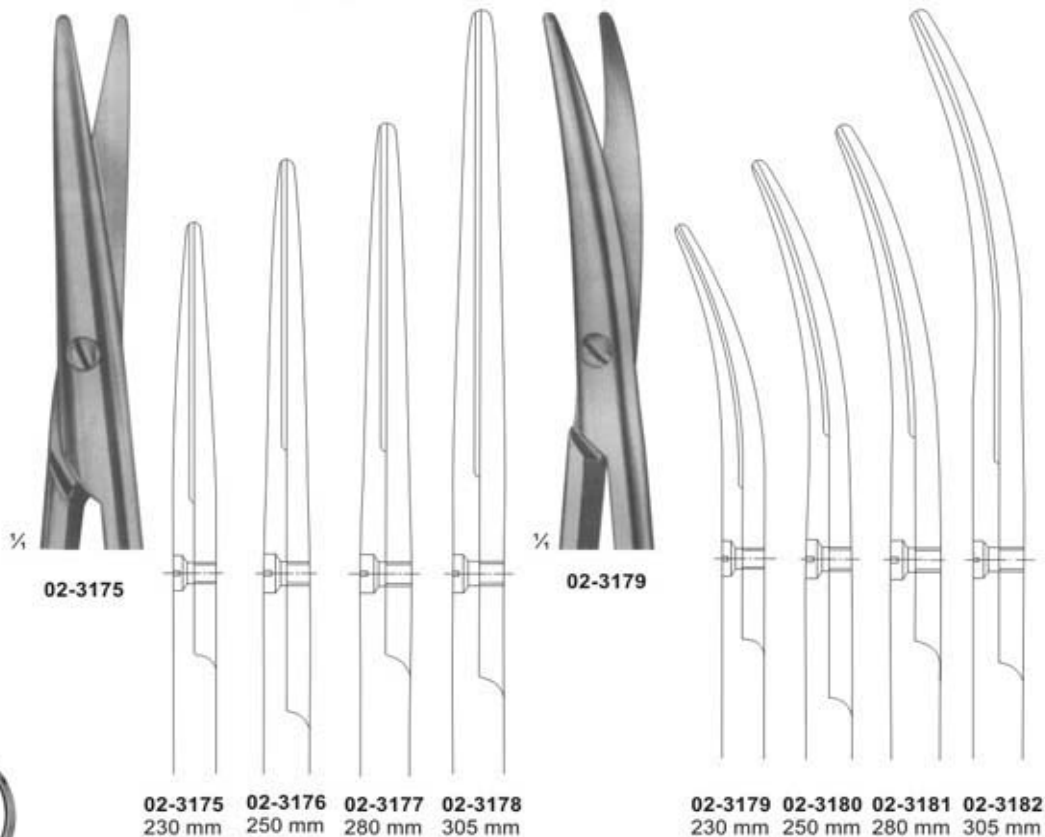
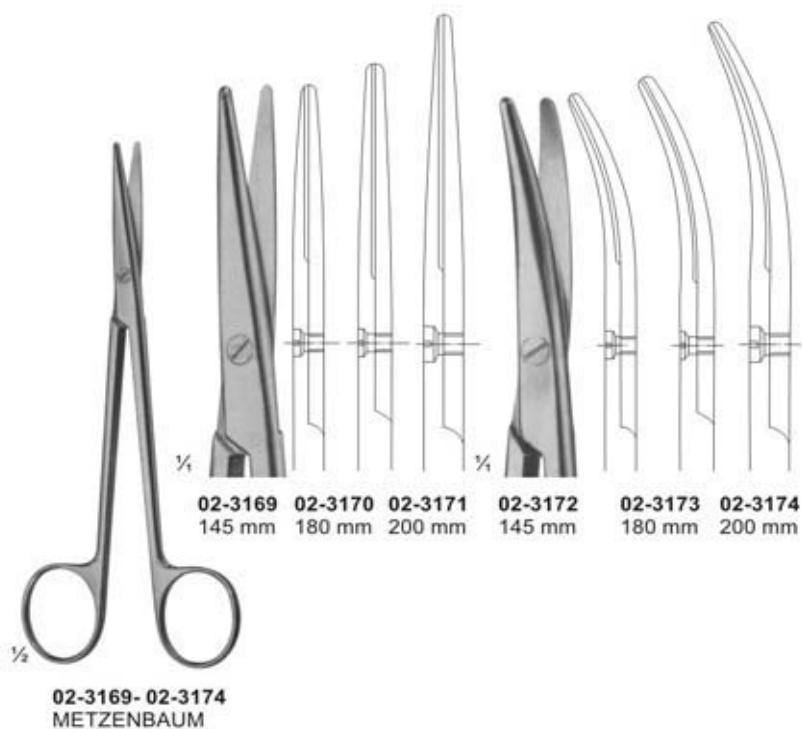
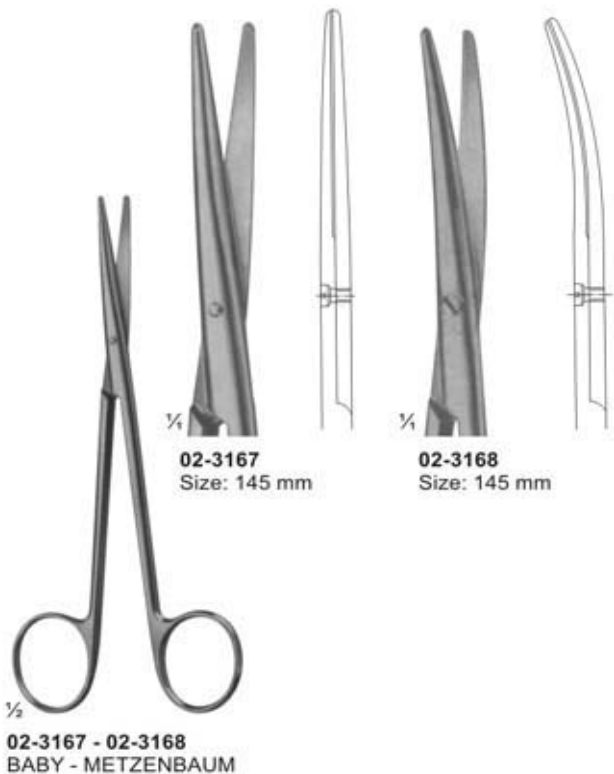

# MICRO SURGERY

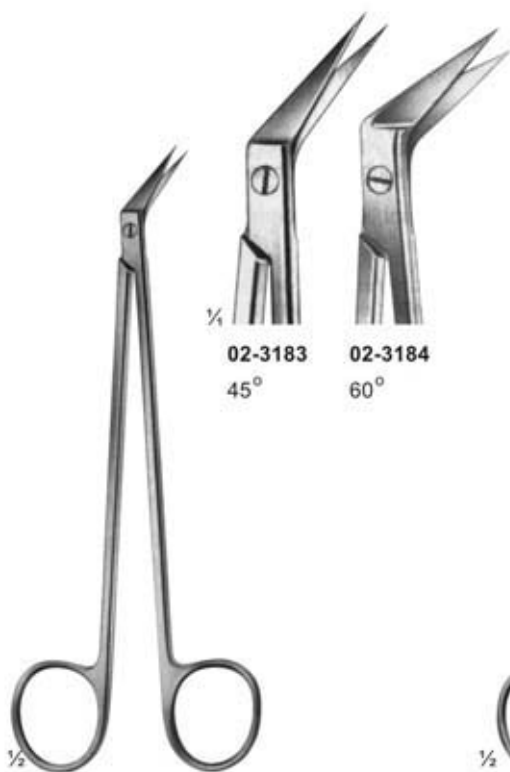

**02-3183 - 02-3184**  
DE BAKEY  
Size: 155 mm

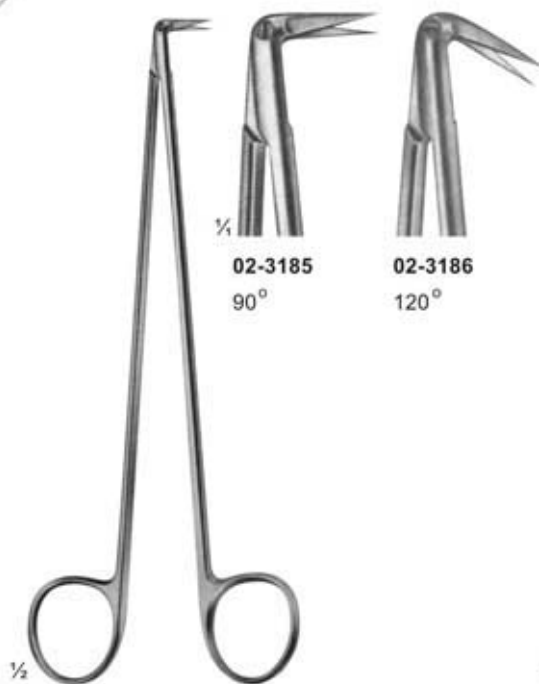

**02-3185 - 02-3186**  
DIETRICH  
Size: 170 mm

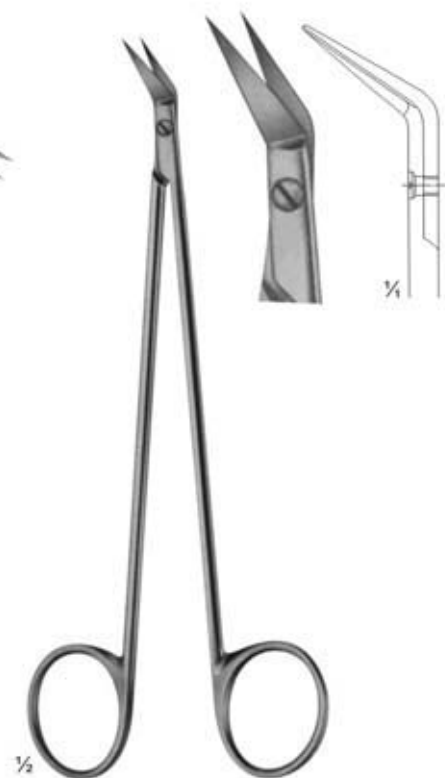

**02-3187**  
POTTS-SMITH  
Size: 180 mm  
55° Angled on Flat

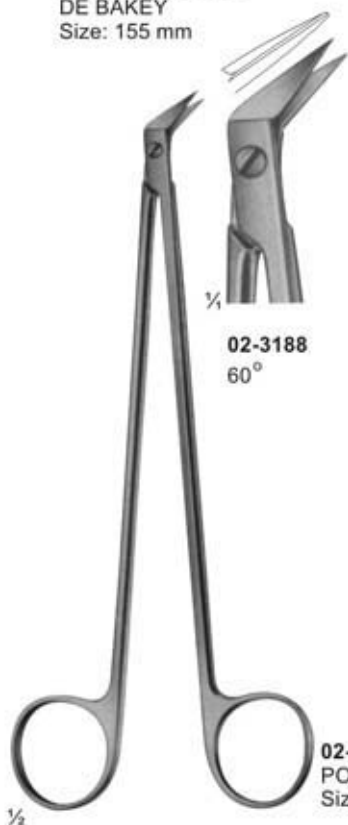

**02-3188**  
POTTS-SMITH  
Size: 180 mm

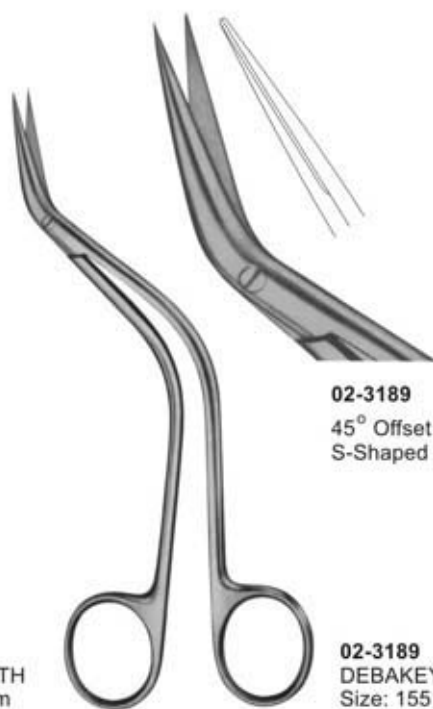

**02-3189**  
45° Offset Scissors  
S-Shaped



**02-3190**  
FAVOLORO  
Coronary Artery  
Scissors  
Size: 140 mm

# MICRO SURGERY



**02-3191**  
**OLIVECRONA**  
Dura Scissors

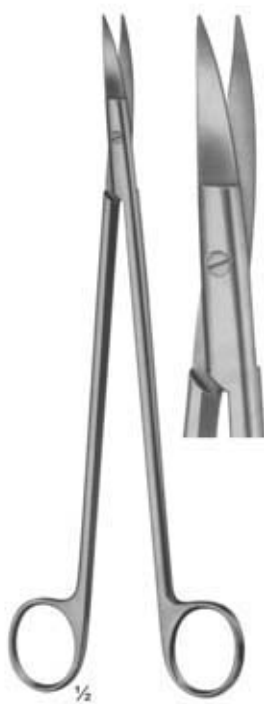

**02-3192**  
**STRULLY**  
Pointed  
Size: 220 mm

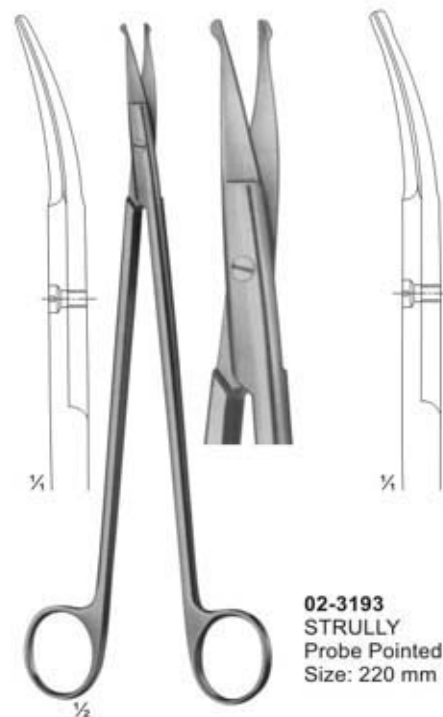

**02-3193**  
**STRULLY**  
Probe Pointed  
Size: 220 mm

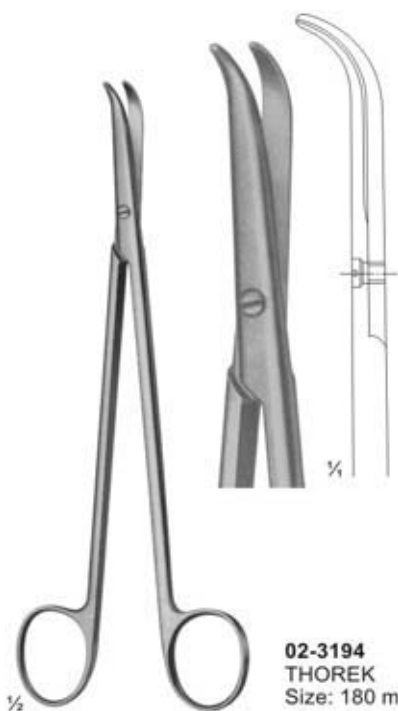

**02-3194**  
**THOREK**  
Size: 180 mm

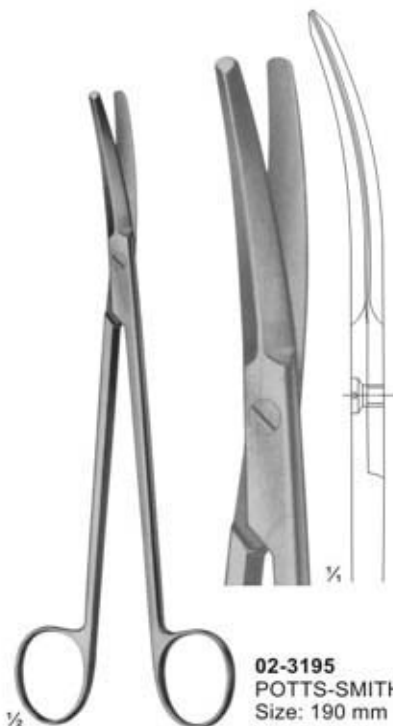

**02-3195**  
**POTTS-SMITH**  
Size: 190 mm

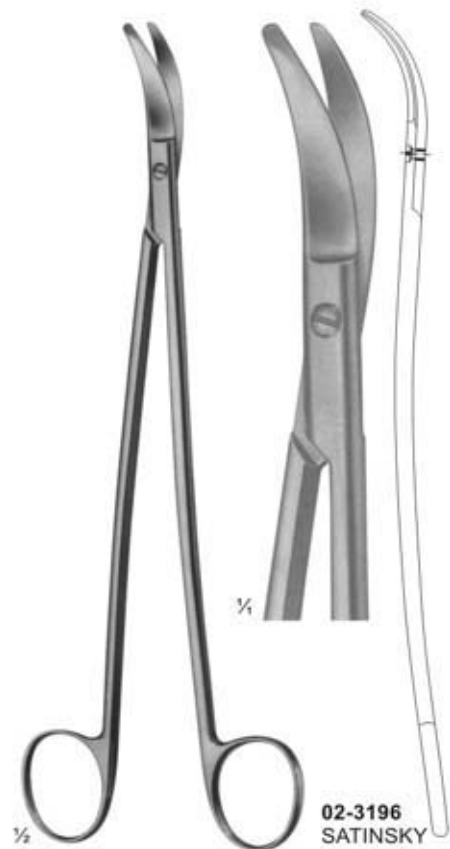

**02-3196**  
**SATINSKY**  
Size: 245 mm

# MICRO SURGERY



**02-3197**  
1 Finely Toothed Blade  
Size: 130 mm

**02-3198**  
LOCKLIN  
Curved Sideways,  
1 Toothed Blade  
Size: 155 mm

**02-3199**  
FOMON  
Blades Serrated  
Size: 145 mm

**02-3200**  
COTTLE  
Size: 165 mm

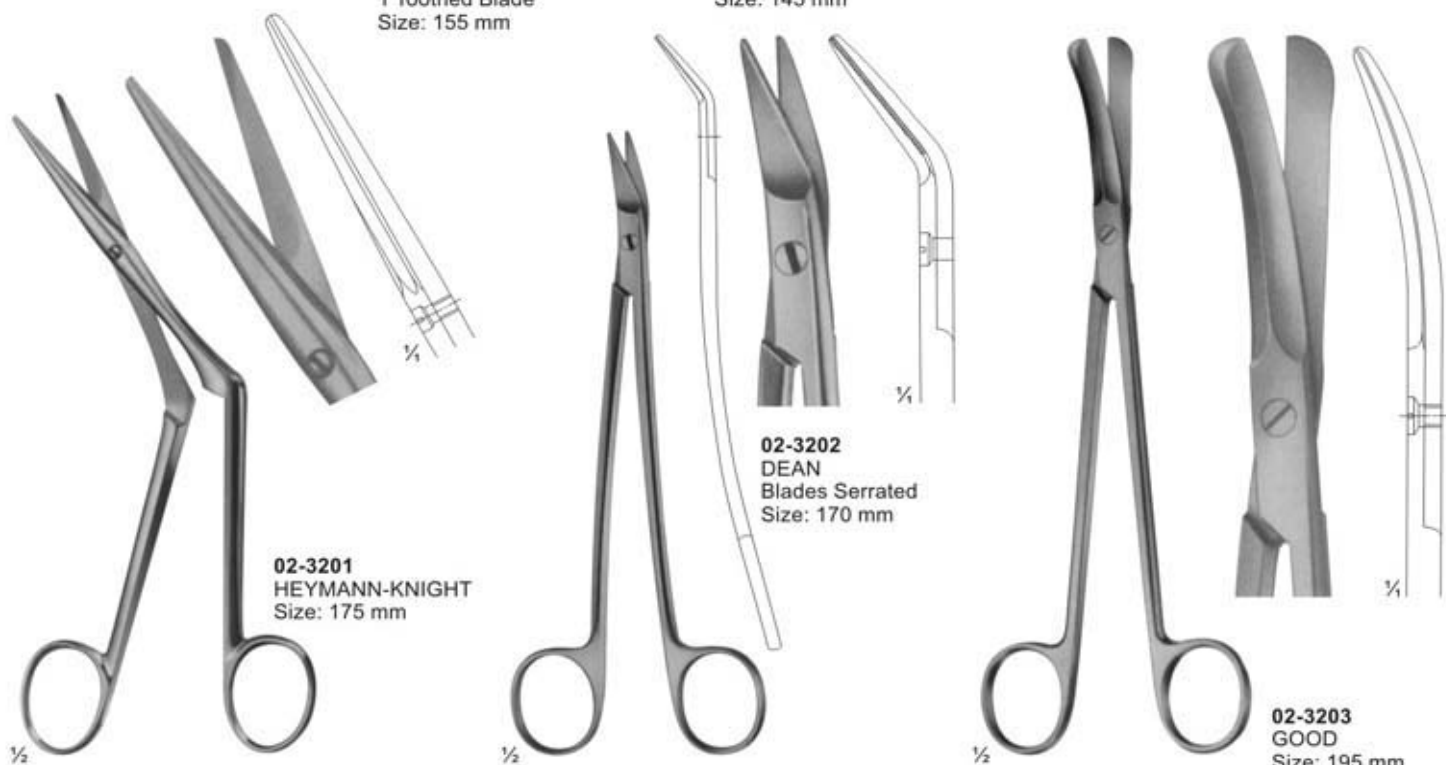

**02-3201**  
HEYMANN-KNIGHT  
Size: 175 mm

**02-3202**  
DEAN  
Blades Serrated  
Size: 170 mm

**02-3203**  
GOOD  
Size: 195 mm

# MICRO SURGERY



**02-3204**  
KILLIAN  
Size: 200 mm



**02-3205 - 02-3206**



**02-3205**  
195 mm

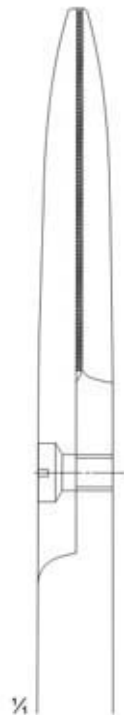

**02-3206**  
225 mm



# MICRO SURGERY

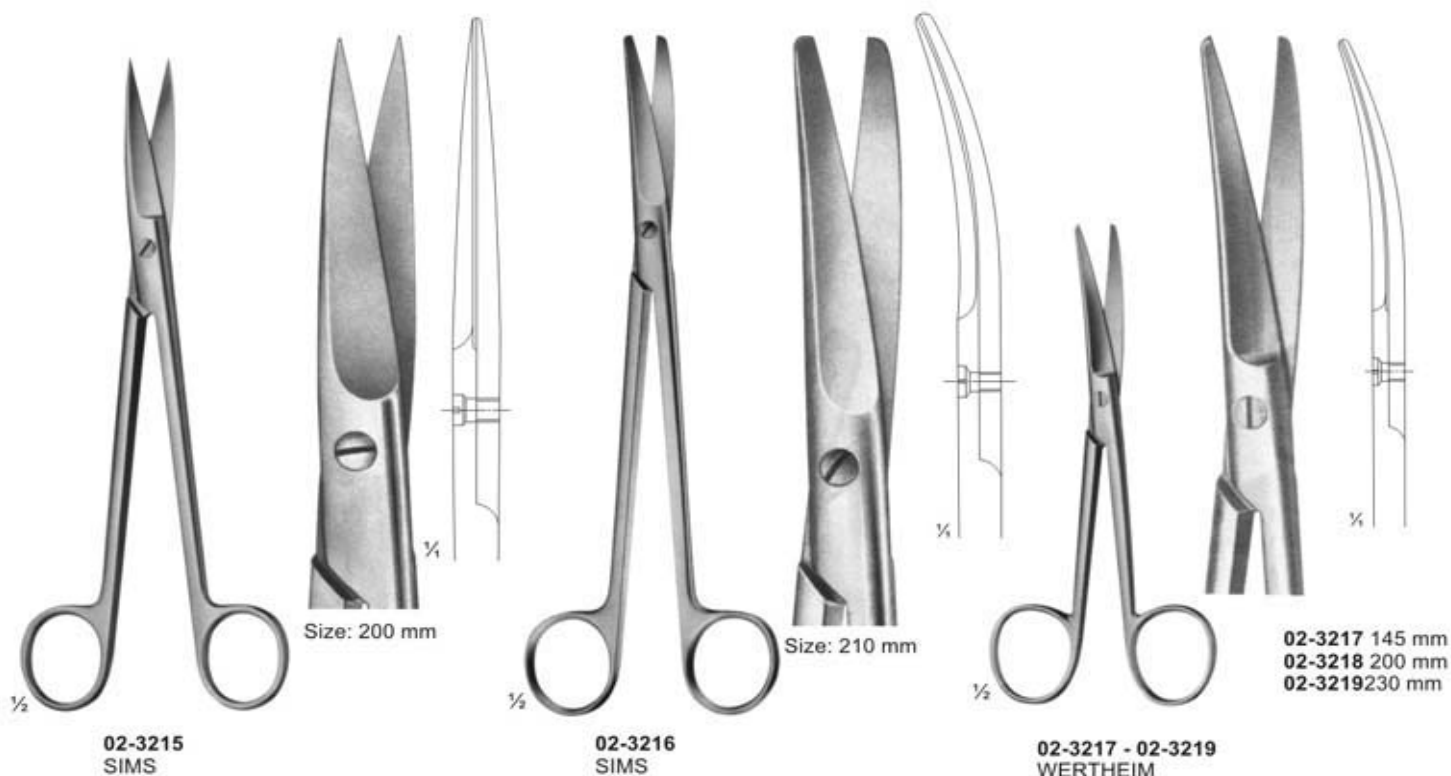
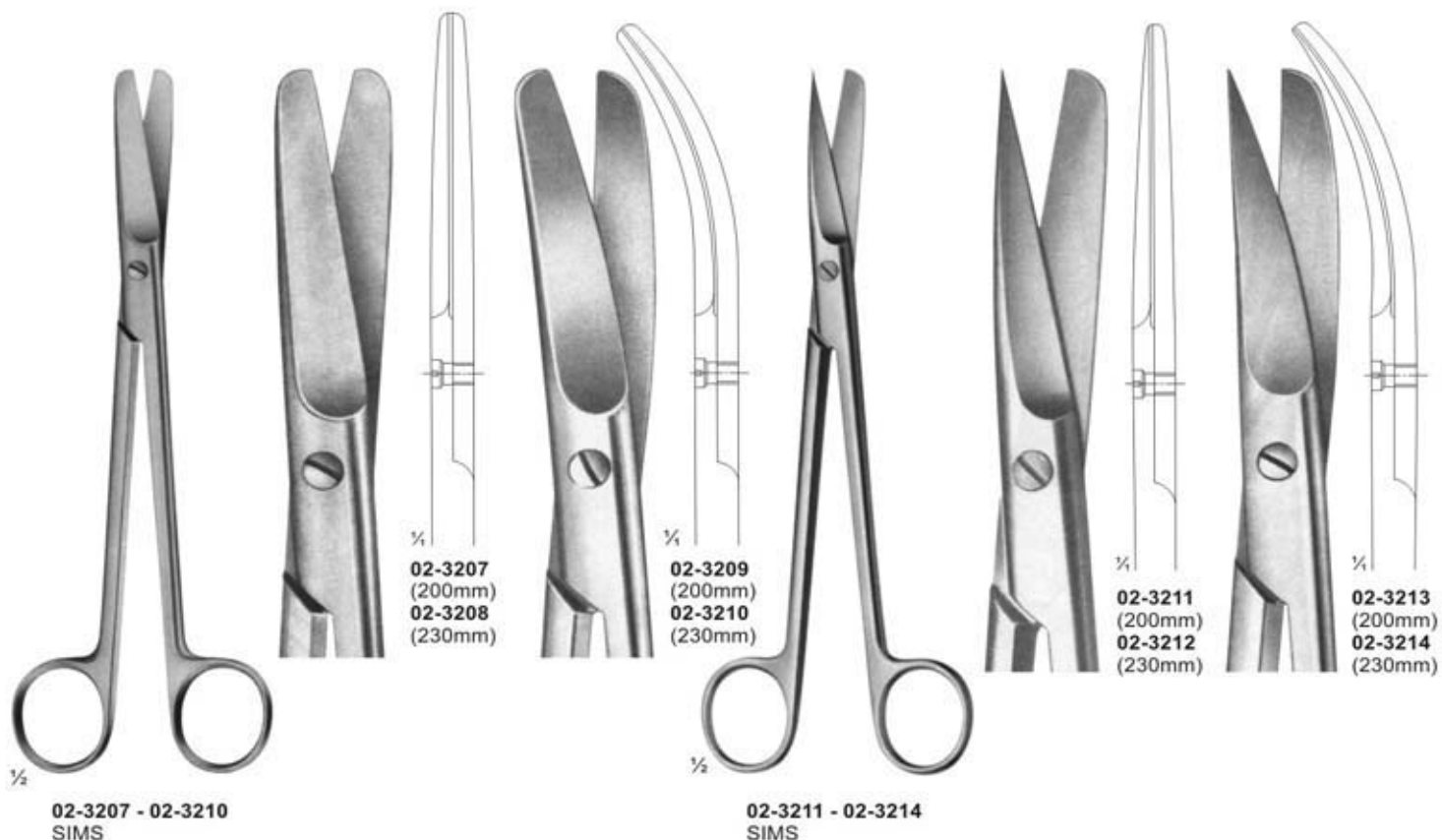

# MICRO SURGERY

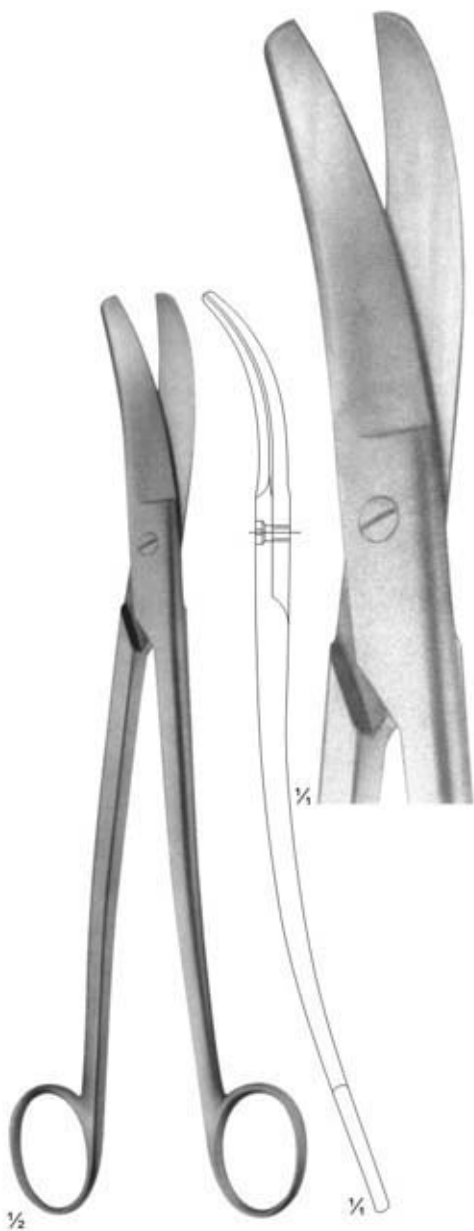

**02-3220**  
**SIEBOLD**  
Uterine Scissors  
Size: 245 mm

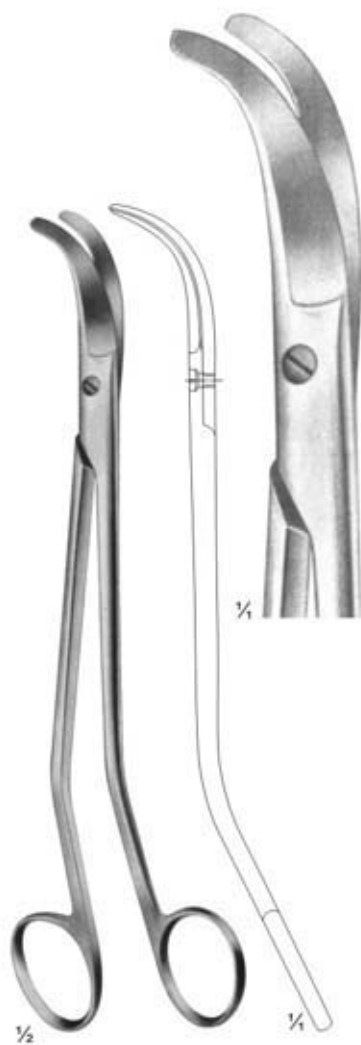

**02-3221**  
**BOZEMANN**  
Uterine Scissors  
Size: 220 mm

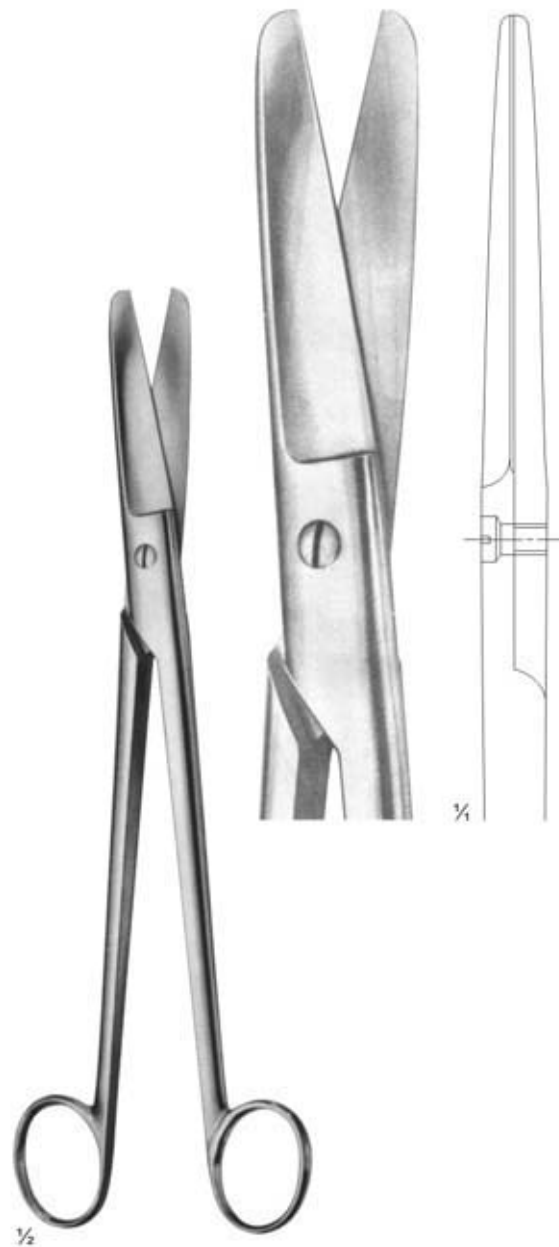

**02-3222**  
**SIMS-SIEBOLD**  
Uterine Scissors  
Size: 250 mm

# MICRO SURGERY



1/2  
**02-3223**  
SCHUMACHER  
Umbilical Cord Scissors  
Size: 155 mm



1/4  
**02-3224**  
Umbilical Cord Scissors  
Size: 105 mm



1/2  
**02-3225**  
Umbilical Cord Scissors

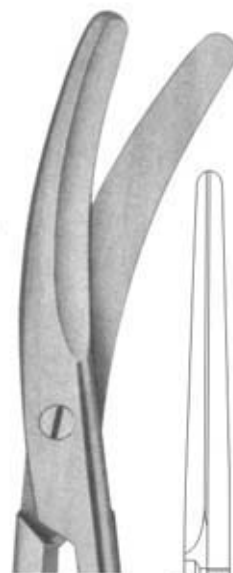

1/4  
135 mm



1/2  
**02-3226 - 02-3227**  
BRAUN-STADLER  
Epistomy Scissors



1/4  
**02-3226**  
145 mm

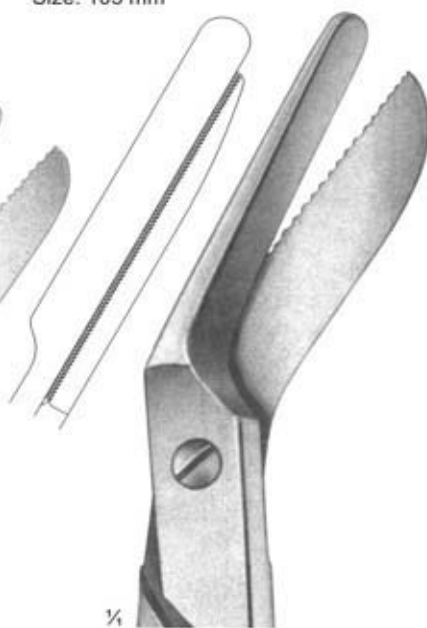

1/4  
**02-3227**  
200 mm



1/2



1/4  
**02-3228**  
Epistomy Scissors  
240 mm



# MICRO SURGERY

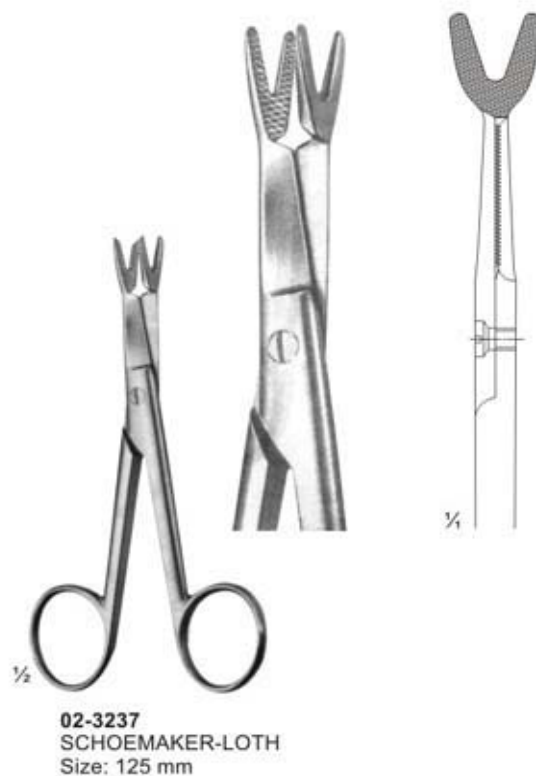
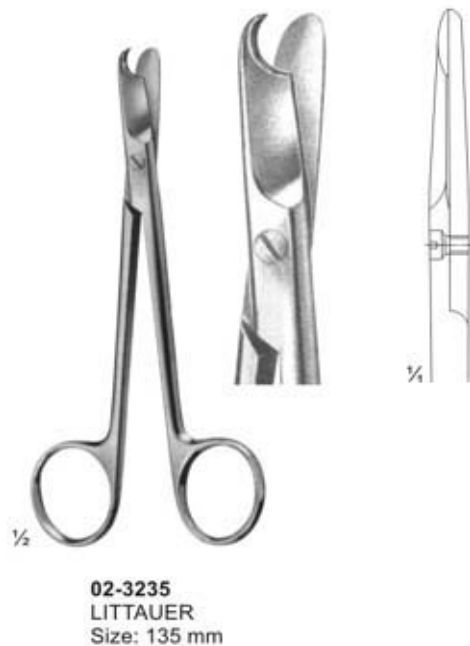

# MICRO SURGERY

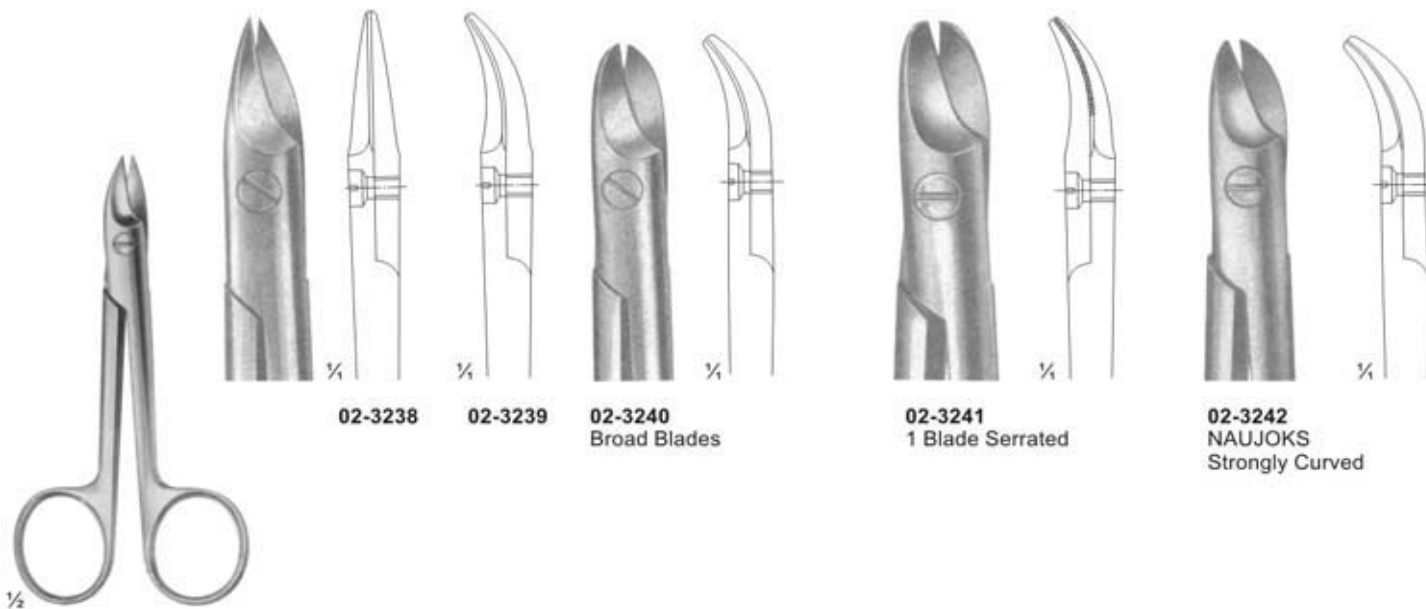

02-3238

02-3239

02-3240  
Broad Blades

02-3241  
1 Blade Serrated

02-3242  
NAUJOKS  
Strongly Curved

02-3238 - 02-3242  
BEEBE  
Size: 110 mm

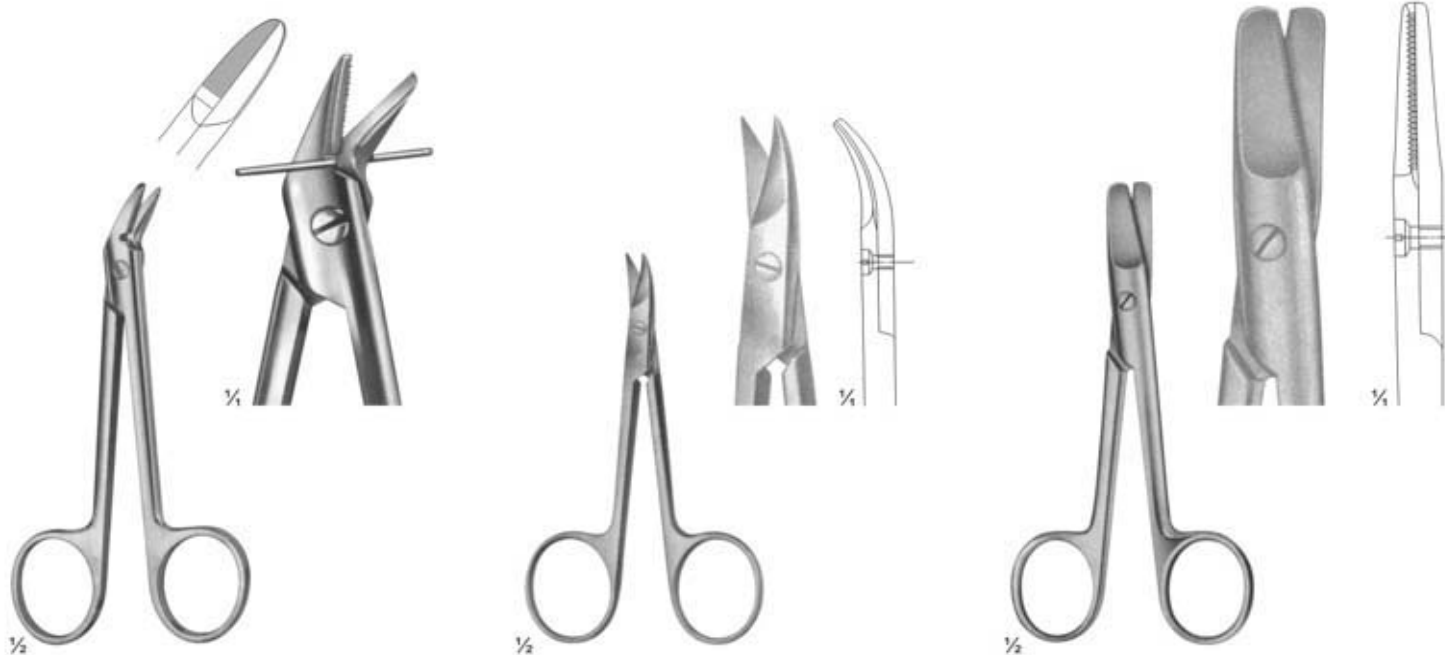

02-3243  
1 Blade Serrated  
Size: 120 mm

02-3244  
STRACK  
Size: 100 mm

02-3245  
HARVEY  
blades serrated  
Size: 125 mm

# MICRO SURGERY



½  
**02-3261**  
UNIVERSAL BANDAGE & CLOTH SCISSORS,  
WITH TOOTHED EDGES, AUTO CLEAVABLE up to 143 °C  
180 mm



½  
**02-3262**  
LISTER BANDAGE & CLOTH  
SCISSORS, WITH TOOTHED EDGES,  
AUTO CLEAVABLE up to 143 °C  
Size: 145 mm

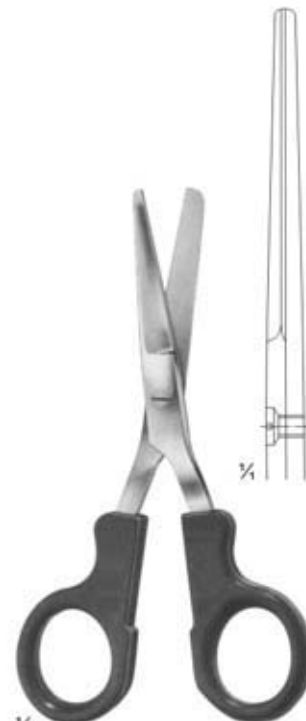

½  
**02-3263**  
NURSE'S SCISSORS  
Size: 145 mm  
AUTO CLEAVABLE up to 143 °C

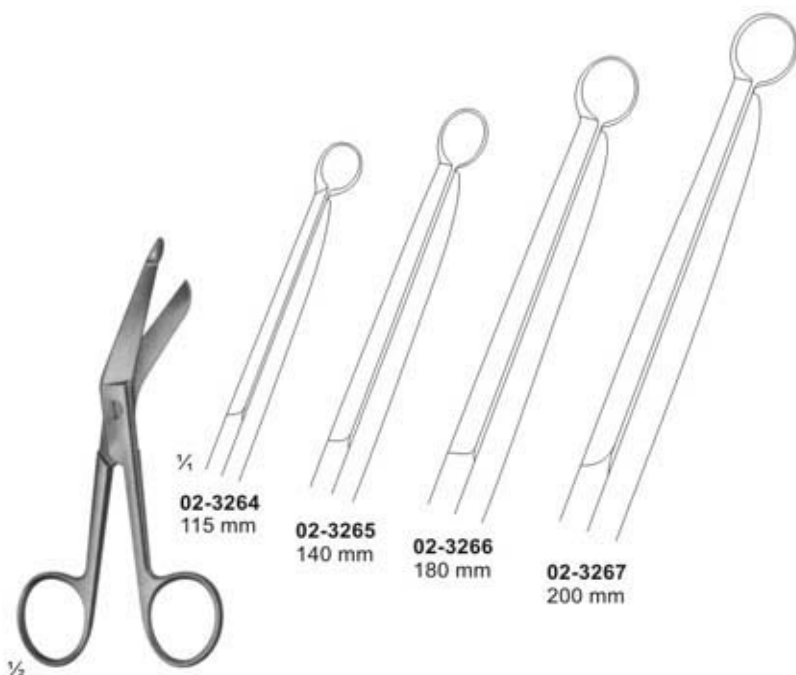

½  
**02-3264 - 02-3267**  
LISTER

¼  
**02-3264**  
115 mm

¼  
**02-3265**  
140 mm

¼  
**02-3266**  
180 mm

¼  
**02-3267**  
200 mm

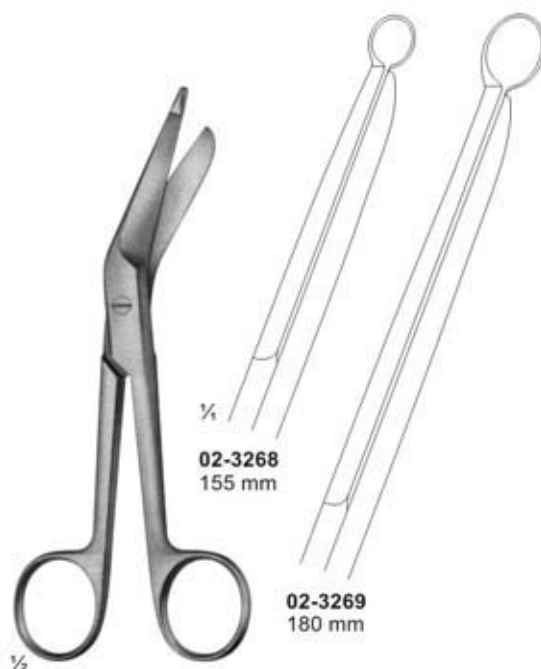

½  
**02-3268 - 02-3269**  
LISTER

¼  
**02-3268**  
155 mm

¼  
**02-3269**  
180 mm

# MICRO SURGERY



**02-3270**  
CLOTH SCISSORS  
205 mm

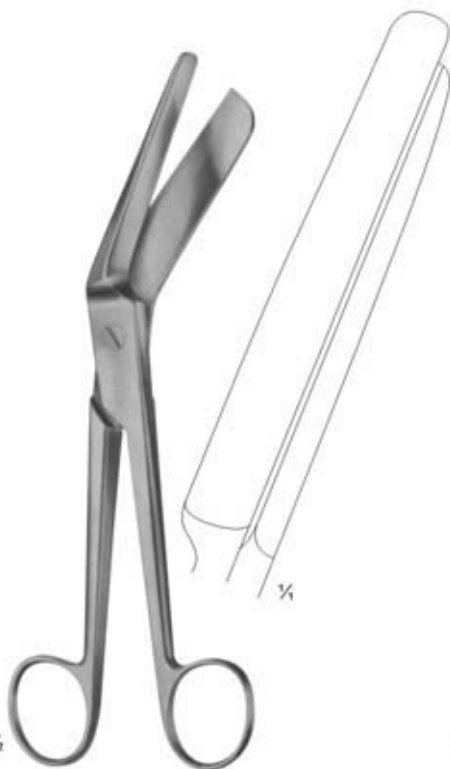

**02-3271**  
BRAUN-STADLER  
Bandage scissors  
225 mm



**02-3272**  
SEUTIN  
Plaster scissors  
230 mm



**02-3273** 200 mm  
**02-3274** 230 mm

**02-3273 - 02-3274**  
ESMARCH (Plaster scissors)

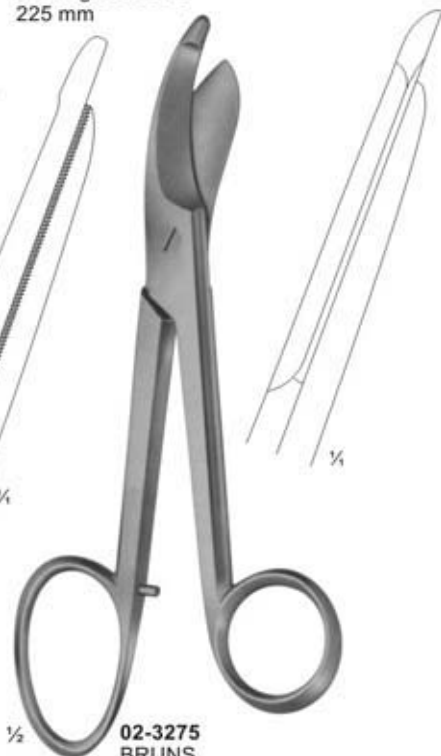

**02-3275**  
BRUNS  
Plaster scissors  
235 mm



**02-3276**  
BANDAGE SCISSORS  
235 mm

# MICRO SURGERY

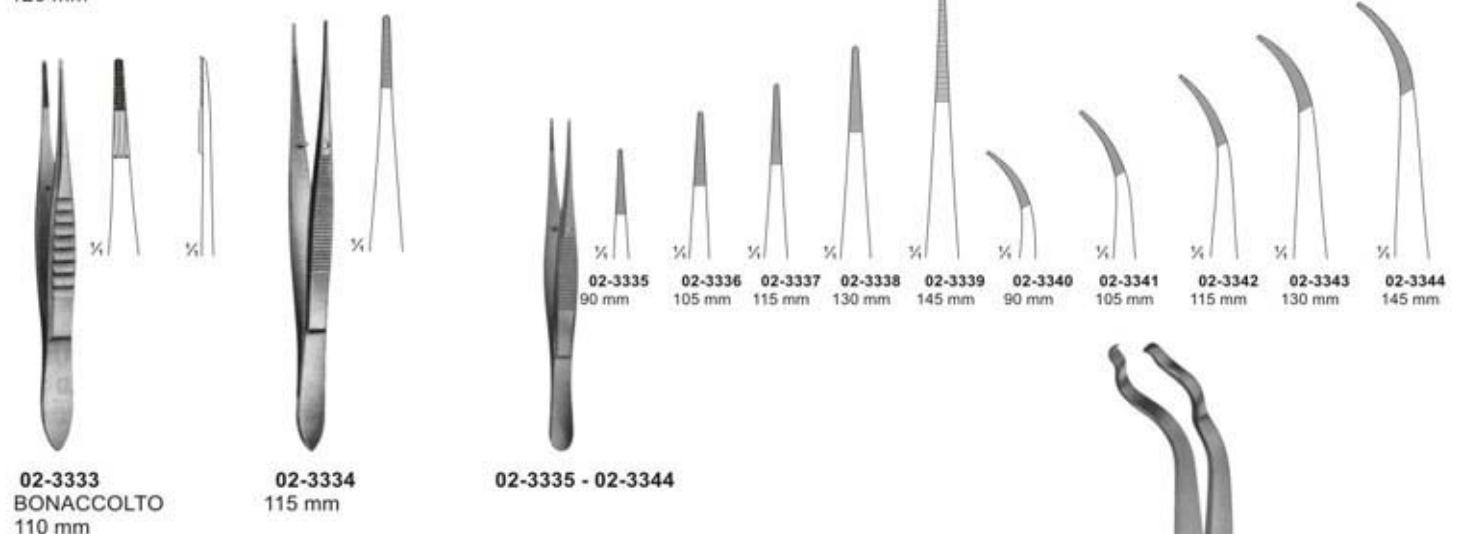
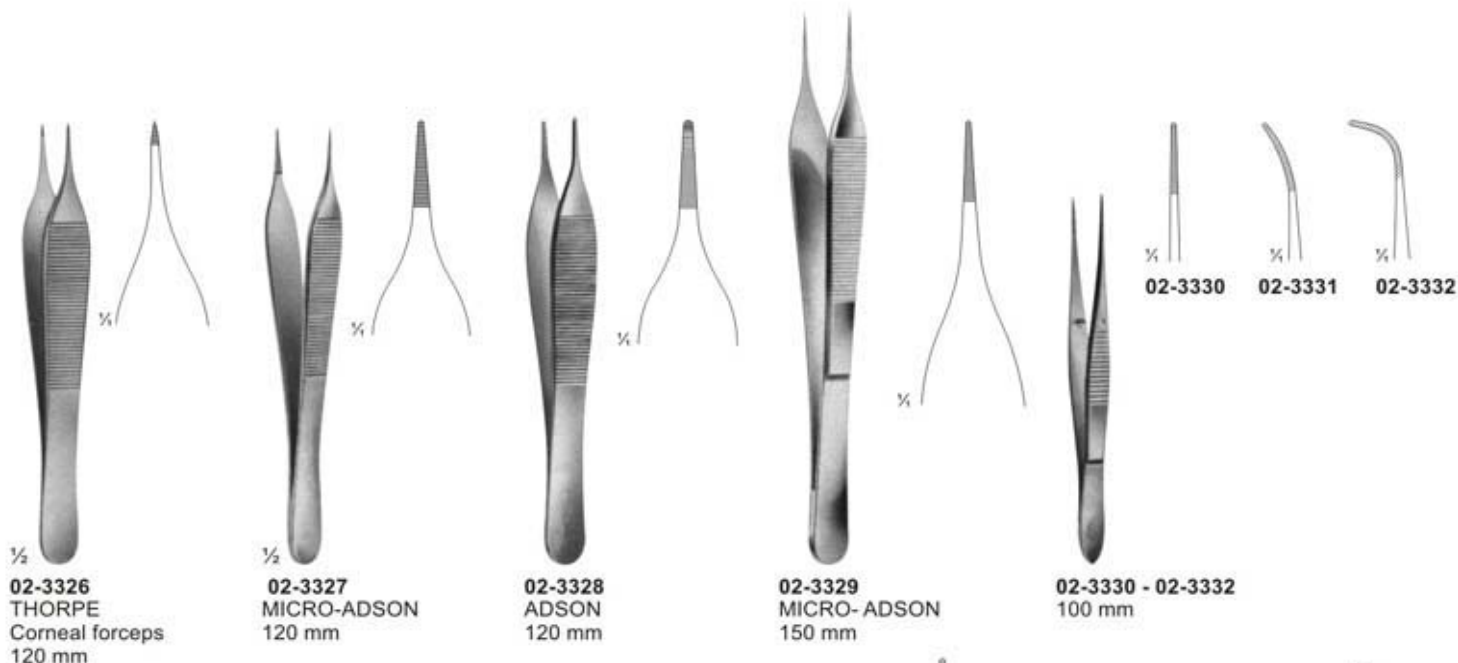

# MICRO SURGERY

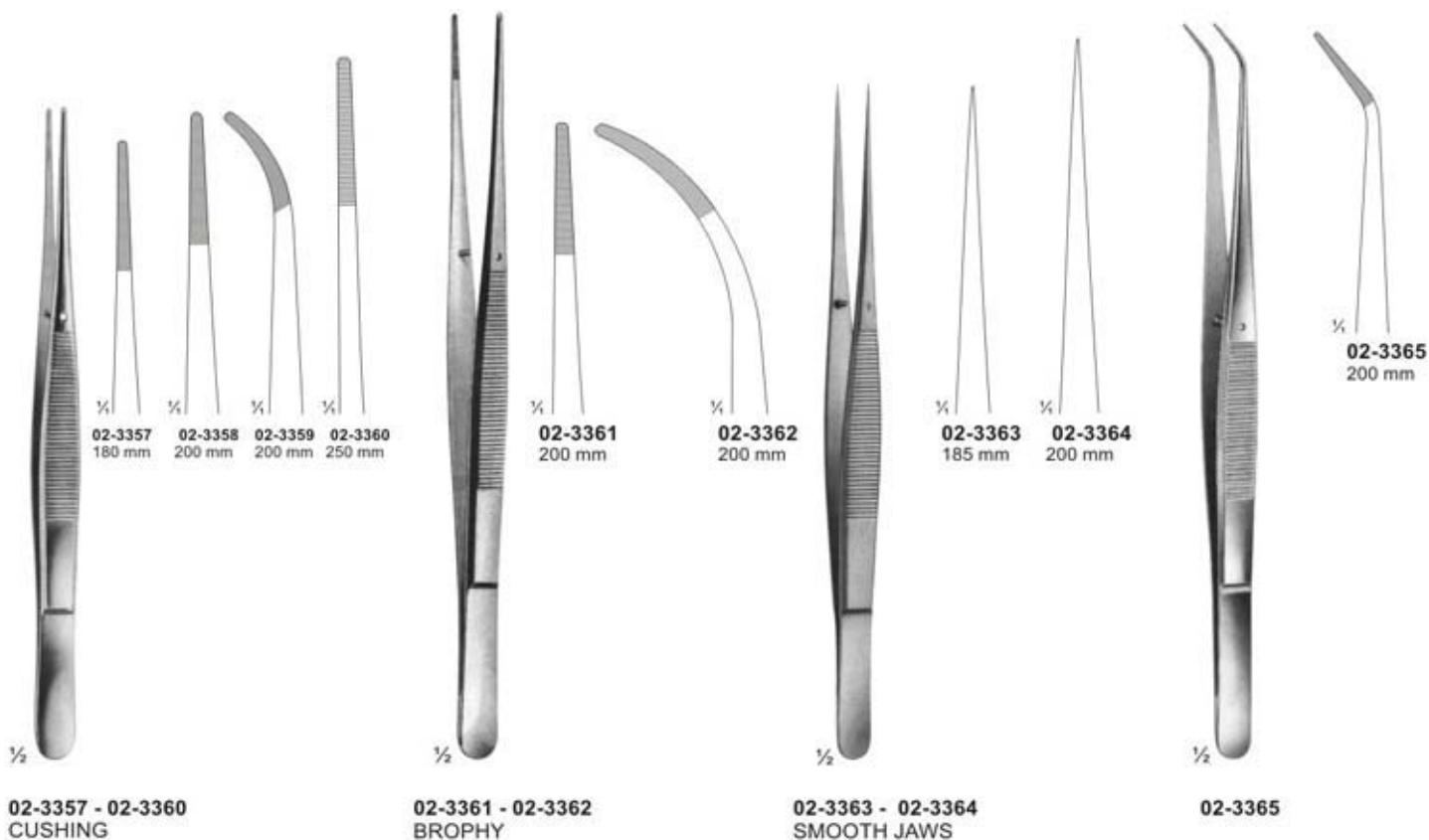
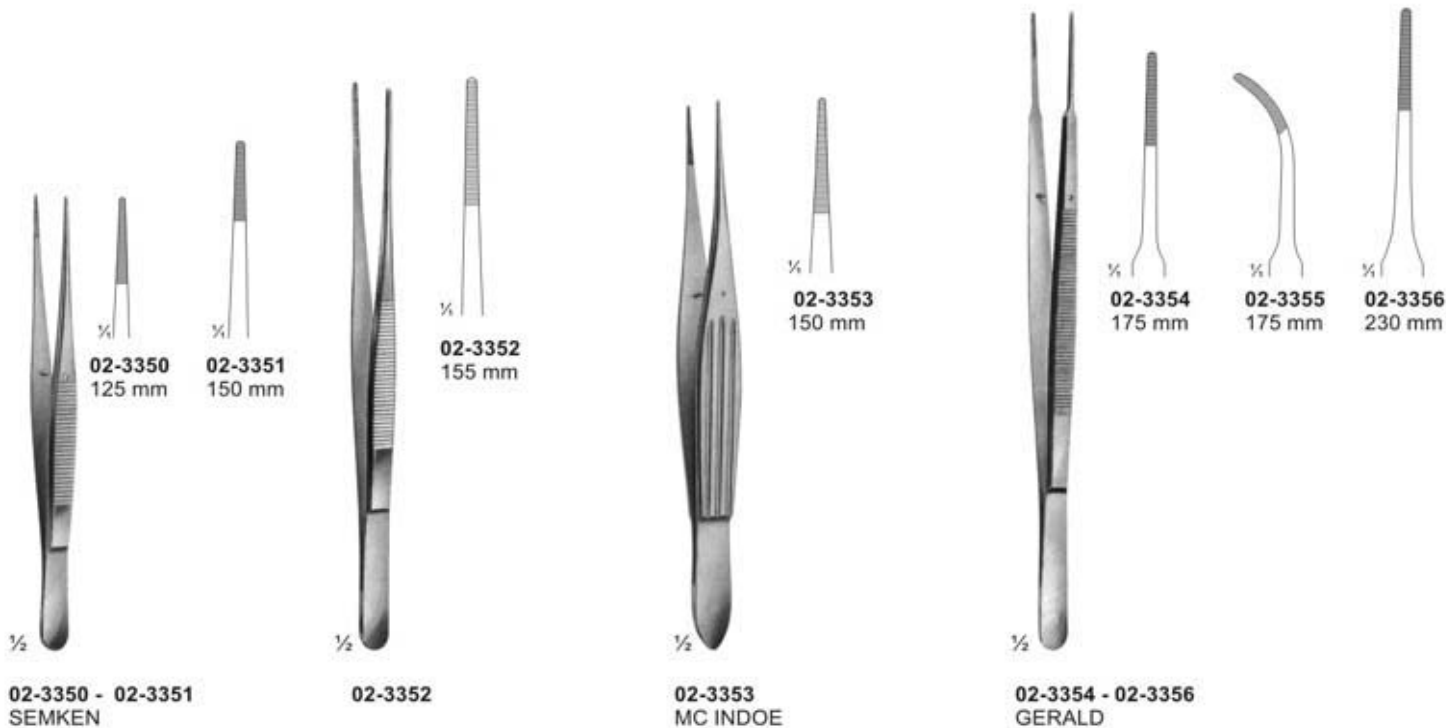

# MICRO SURGERY



¼  
**02-3366**  
115 mm



¼  
**02-3367**  
130 mm



¼  
**02-3368**  
145 mm



¼  
**02-3369**  
160 mm



¼  
**02-3370**  
180 mm



¼  
**02-3371**  
200 mm



¼  
**02-3372**  
250 mm



¼  
**02-3373**  
300 mm

**02-3366 - 03-3373**  
STANDARD



¼  
**02-3374**  
115 mm



¼  
**02-3375**  
130 mm



¼  
**02-3376**  
145 mm



¼  
**02-3377**  
160 mm



¼  
**02-3378**  
305 mm



¼  
**02-3379**  
130 mm



¼  
**02-3380**  
145 mm

**02-3374 - 02-3378**  
MEDIUM

**02-3379 - 02-3380**  
MEDIUM

# MICRO SURGERY

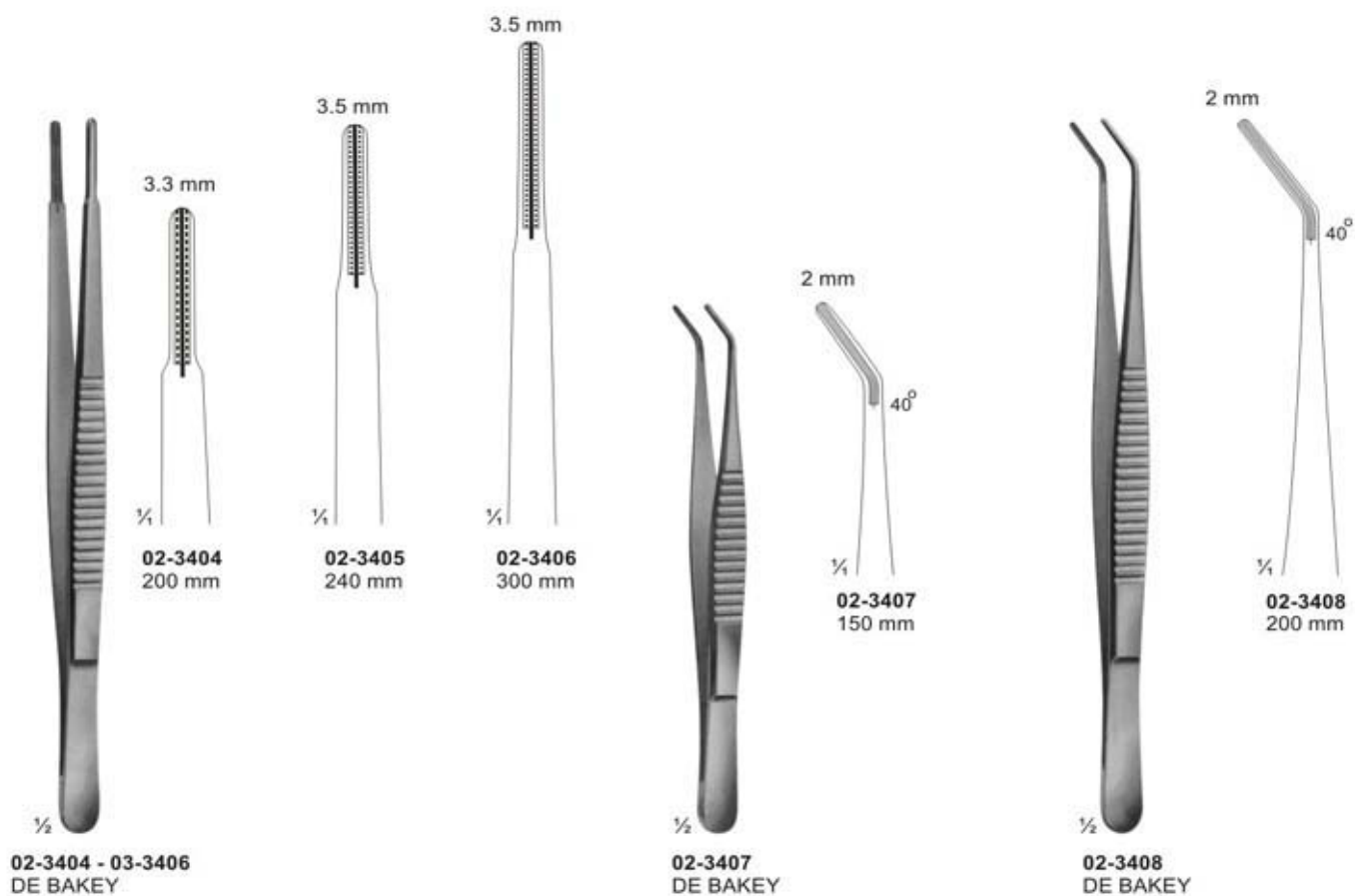
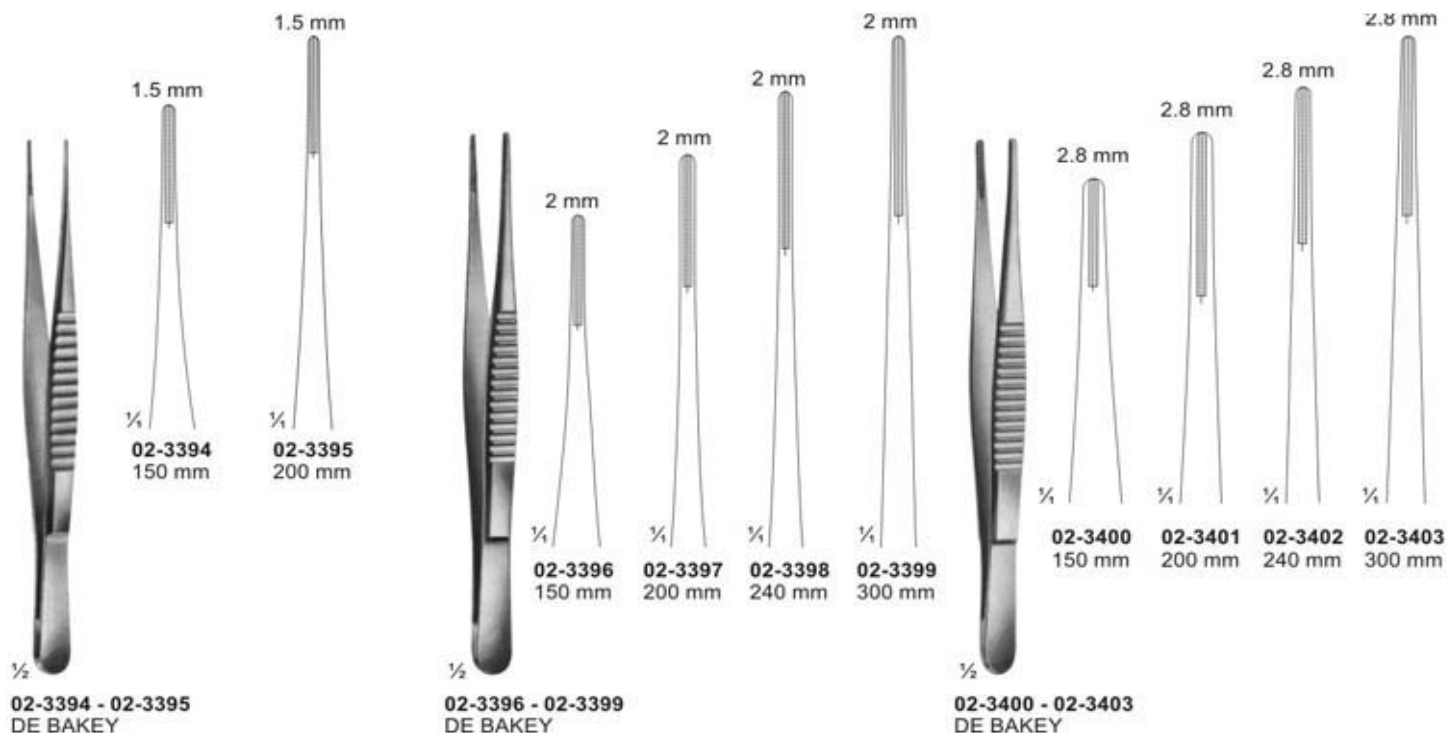

# MICRO SURGERY



**02-3421**  
BISHOP-HARMON  
85 mm

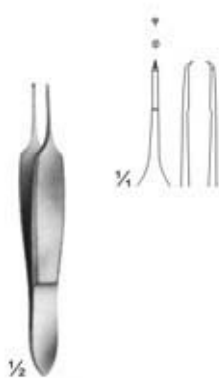

**02-3422**  
ST. MARTIN  
80 mm

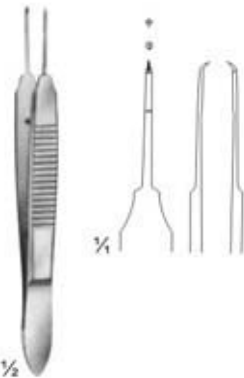

**02-3423**  
CASTROVIEJO  
teeth 0.9 mm  
100 mm

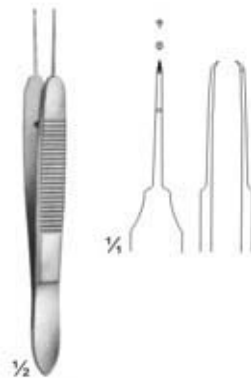

**02-3424**  
CASTROVIEJO  
teeth 0.5 mm  
100 mm

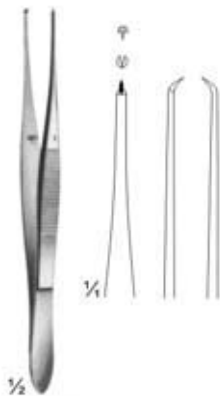

**02-3425**  
ELSCHING  
110 mm



**02-3426**  
GILL  
75 mm



**02-3427**  
GILL - HESS  
75 mm

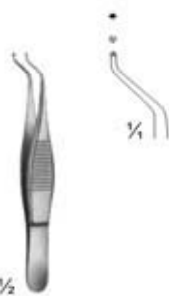

**02-3428**  
HESS  
70 mm



**02-3429**  
ARRUGA  
100 mm

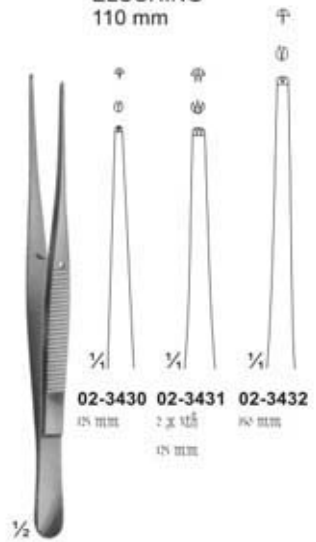

**02-3430** 125 mm  
**02-3431** 2 x 125 mm  
**02-3432** 150 mm

**02-3430 - 02-3432**  
SEMKEN



**02-3433**  
MICRO-ADSON  
120 mm

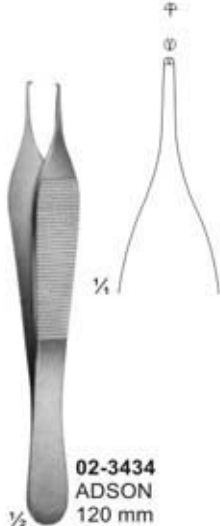

**02-3434**  
ADSON  
120 mm

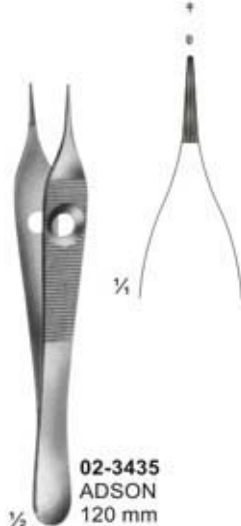

**02-3435**  
ADSON  
120 mm



**02-3436**  
ADSON  
120 mm



**02-3437**  
ADSON  
120 mm

# MICRO SURGERY



**02-3438**  
ADSON - BROWN  
Non-traumatic  
120 mm



**02-3439**  
BROWN  
150 mm



**02-3440**  
GRAEFE  
110 mm



**02-3441**  
GRAEFE  
With Catch  
110 mm

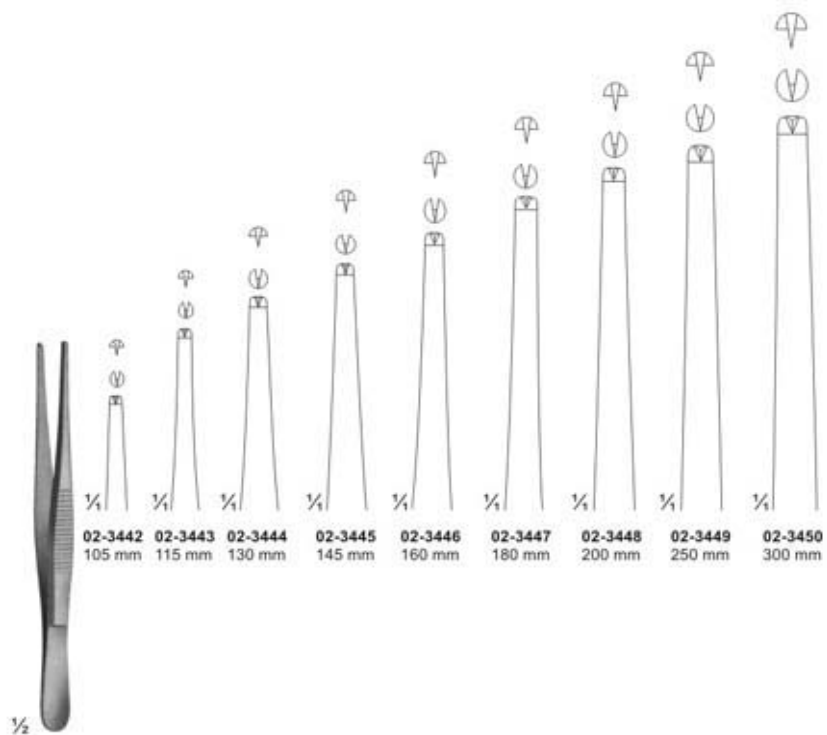

**02-3442 - 02-3450**  
STANDARD

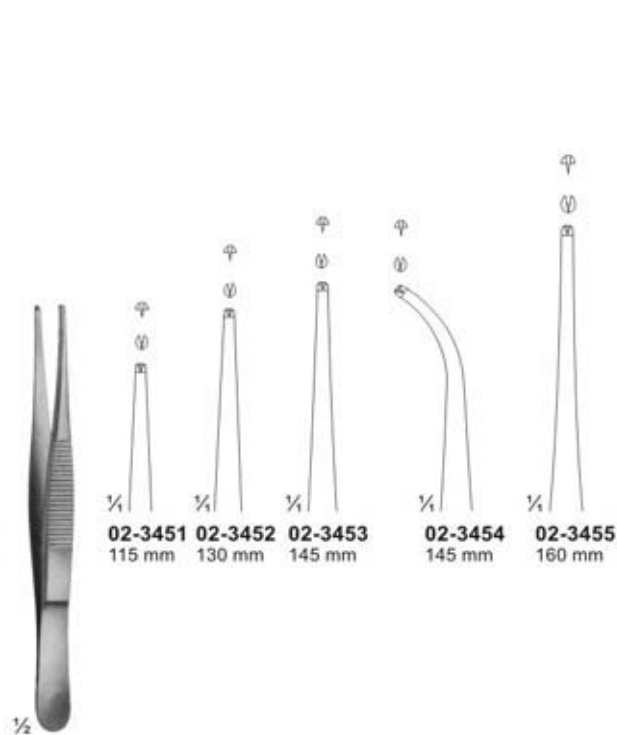

**02-3451 - 02-3455**  
Medium

# MICRO SURGERY



**02-3496**  
BRYANT  
130 mm

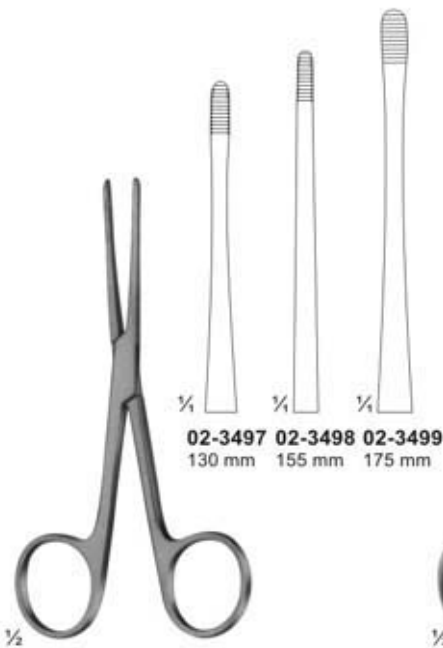

**02-3497 - 02-3499**  
LISTER  
Sinus Forceps

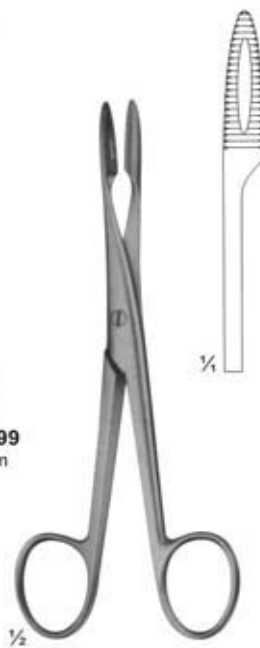

**02-3500**  
Without Ratchet  
145 mm

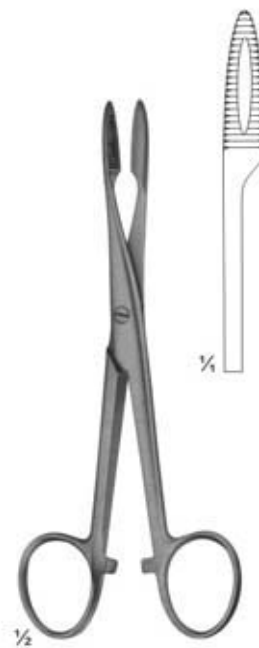

**02-3501**  
With Ratchet  
145 mm

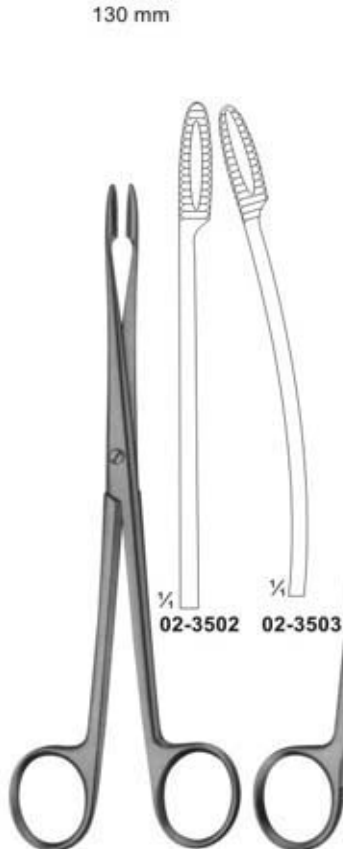

**02-3502 - 02-3503**  
GROSS  
Without Ratchet  
180 mm

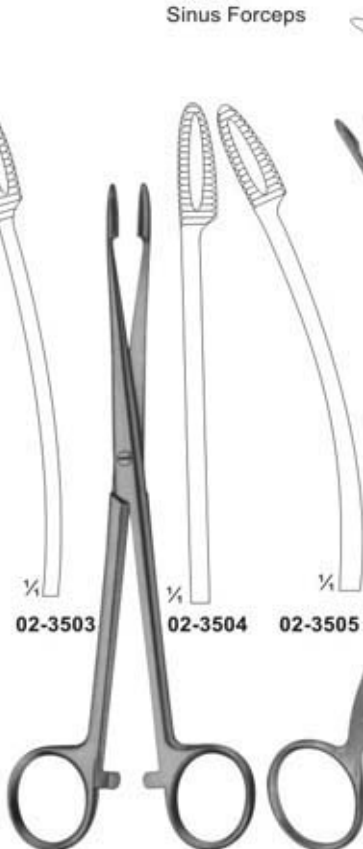

**02-3504 - 02-3505**  
GROSS  
With Ratchet  
180 mm

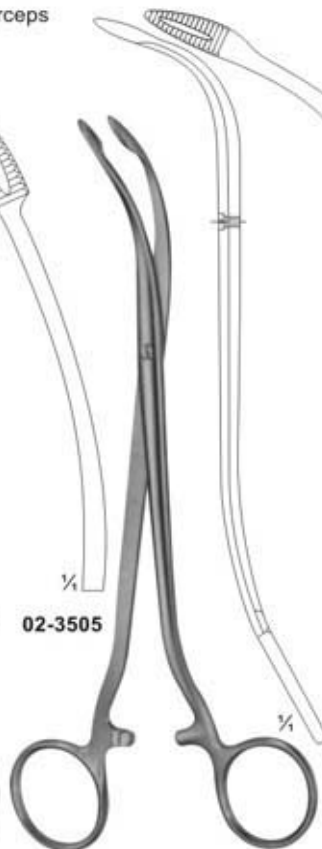

**02-3506**  
DUPLAY  
190 mm

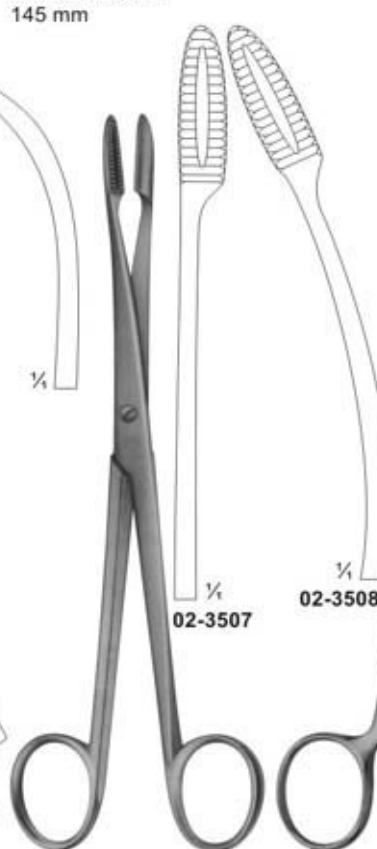

**02-3507 - 02-3508**  
GROSS  
Without Ratchet  
200 mm

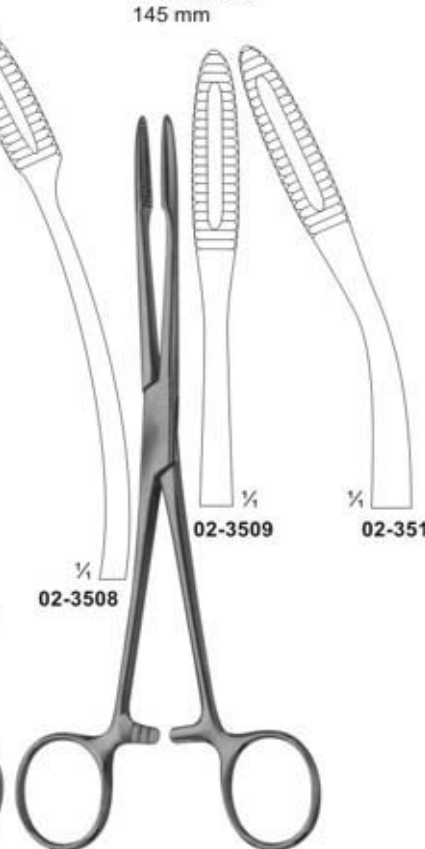

**02-3509 - 02-3510**  
GROSS  
With Ratchet  
200 mm

# MICRO SURGERY

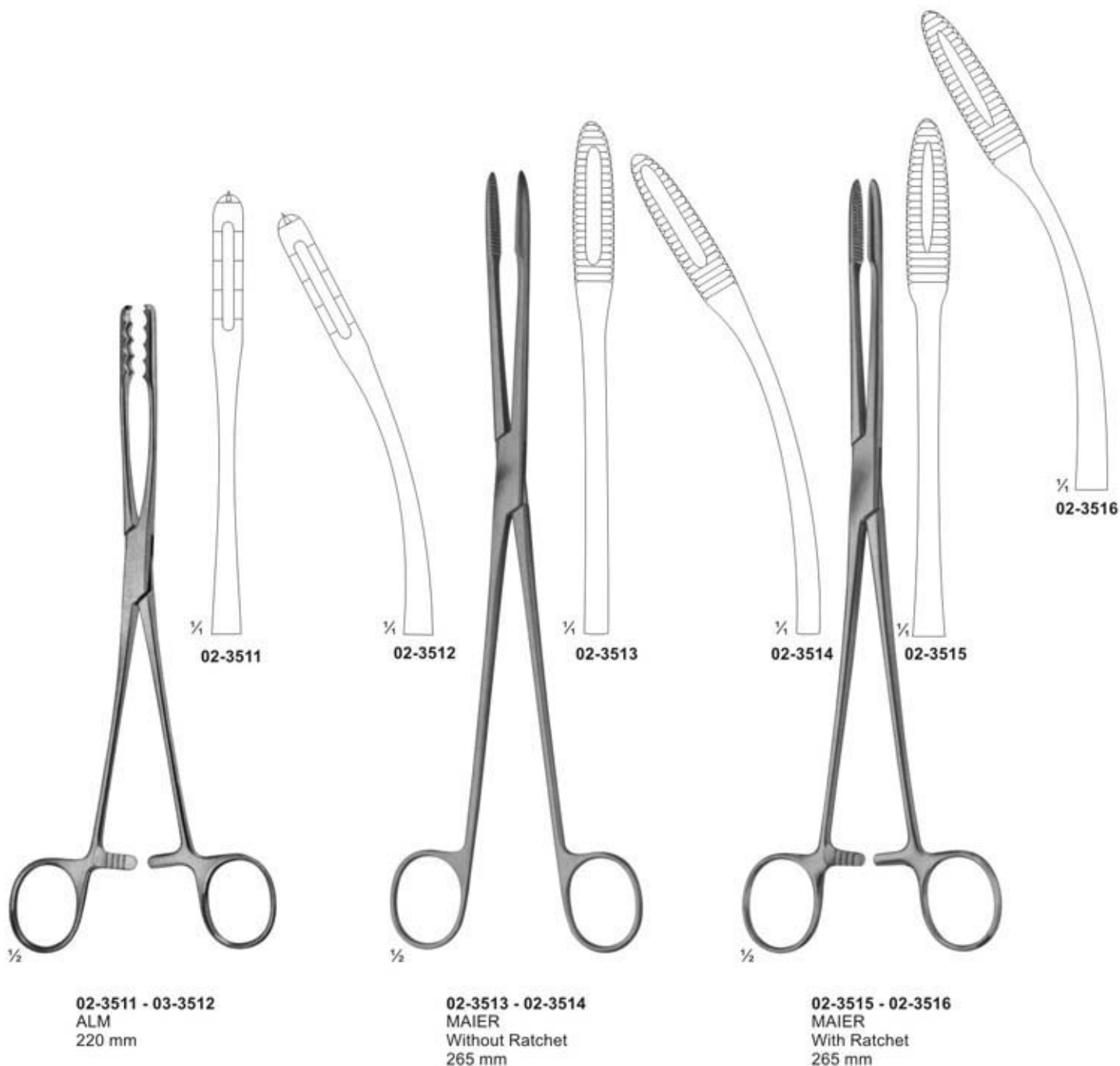

**02-3511 - 03-3512**  
ALM  
220 mm

**02-3513 - 02-3514**  
MAIER  
Without Ratchet  
265 mm

**02-3515 - 02-3516**  
MAIER  
With Ratchet  
265 mm

# MICRO SURGERY

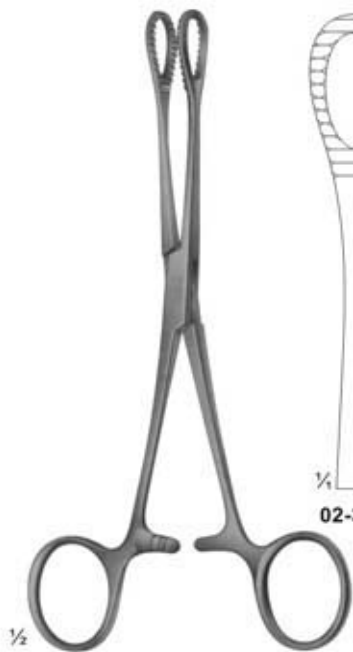

02-3522



02-3523

02-3522 - 02-3523  
FOERSTER-BALLENGER  
180 mm



02-3524  
180 mm

02-3524 - 02-3525  
RAMPLEY



02-3525  
250 mm



02-3526  
Smooth Jaws



02-3527    02-3528  
Smooth Jaws    Serrated Jaws

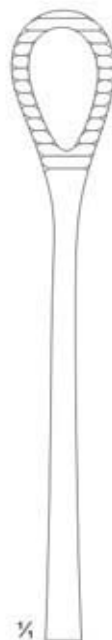

02-3529  
Serrated Jaws

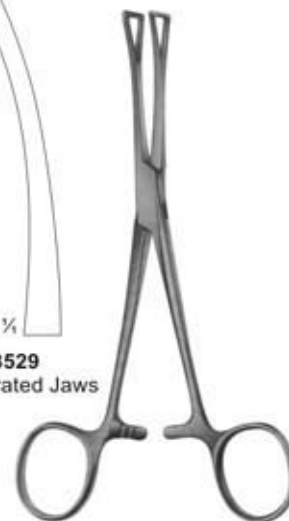

02-3530  
PENNINGTON  
155 mm

02-3526 - 02-3529  
FOERSTER-BALLENGER  
240 mm

# MICRO SURGERY



02-3539

02-3540

1/2  
02-3539 - 02-3540  
HERZ  
155 mm



02-3541

1/2  
02-3541  
JACKSON  
4 x 5 teeth  
150 mm

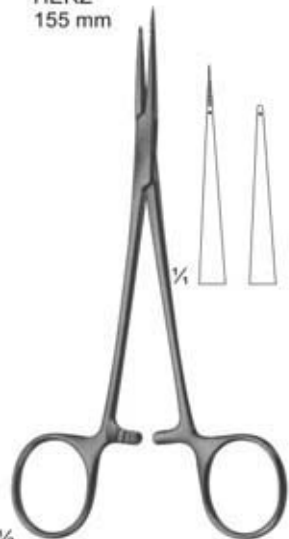

1/2  
02-3542  
Tendon interlacing  
forceps  
150 mm



1/2  
02-3543  
Tendon interlacing  
forceps  
150 mm



1/2  
02-3544  
Tendon seizing  
forceps  
120 mm

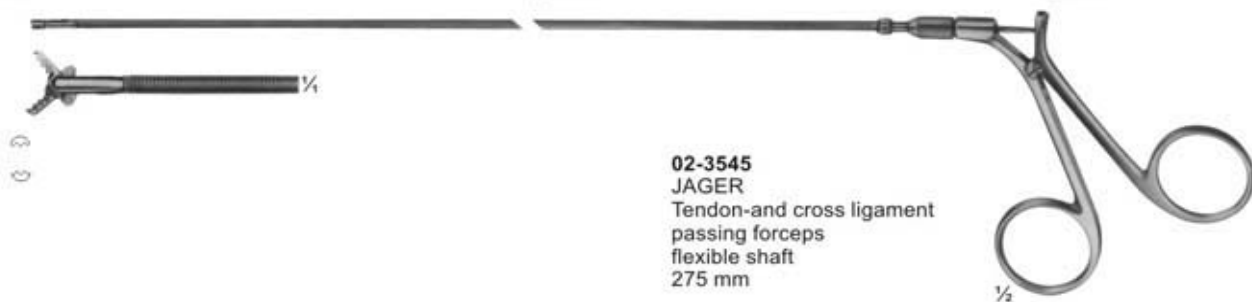

02-3545  
JAGER  
Tendon-and cross ligament  
passing forceps  
flexible shaft  
275 mm

# MICRO SURGERY

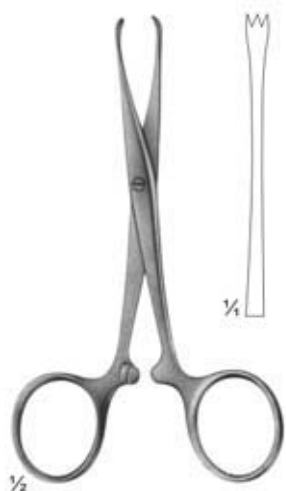

**02-3546**  
CHAPUT  
2 x 3 teeth sharp  
125 mm

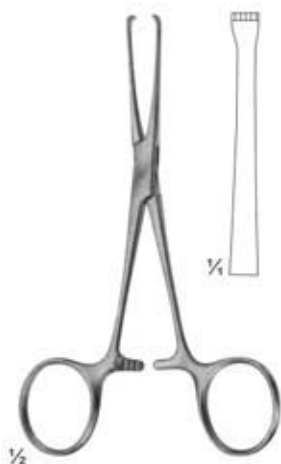

**02-3547**  
BABY-ALLIS  
4 x 5 teeth  
130 mm

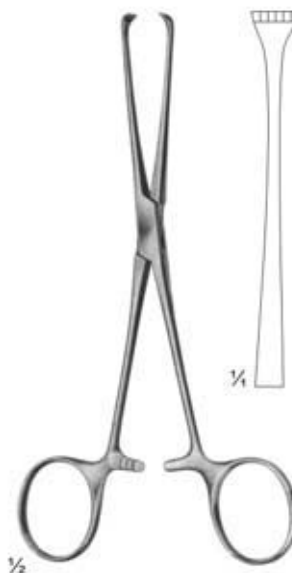

**02-3548**  
BOYS-ALLIS  
5 x 6 teeth sharp  
155 mm

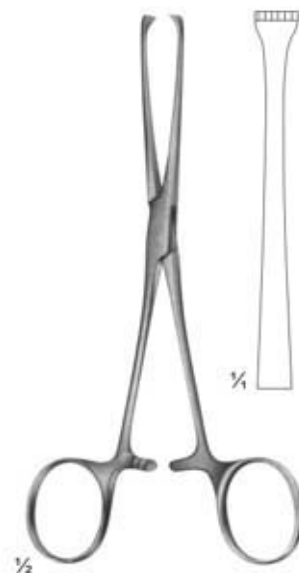

**02-3549**  
ALLIS  
5 x 6 teeth blunt  
155 mm



**02-3550**  
LAHEY  
155 mm

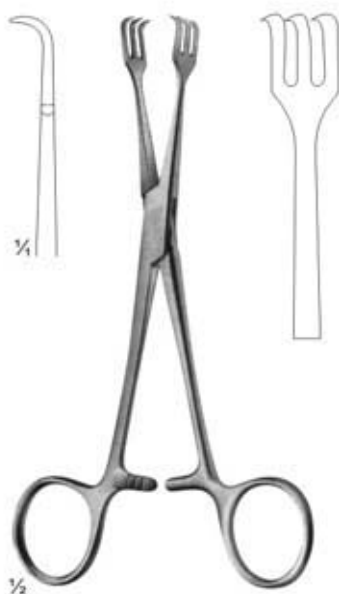

**02-3551**  
LAHEY  
155 mm

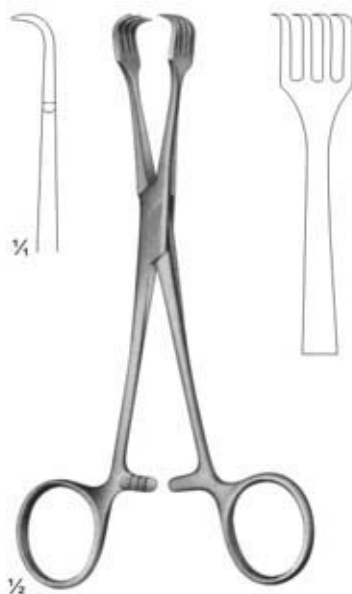

**02-3552**  
BRAUN  
155 mm

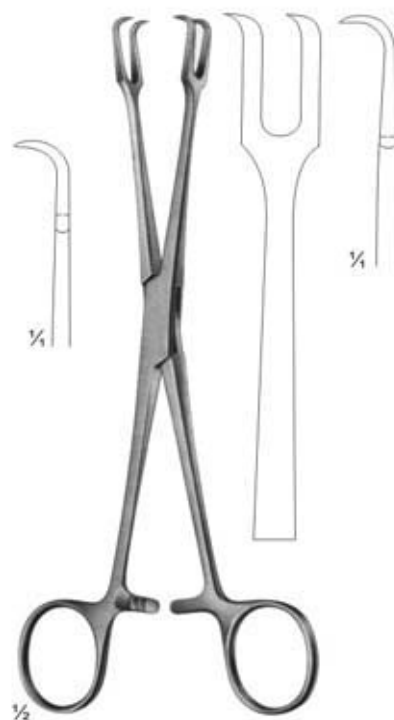

**02-3553**  
MUSEUX  
200 mm

# MICRO SURGERY



**02-3558**  
JONES  
85 mm



**02-3559**  
ENGL. MOD.  
85 mm



**02-3560 - 02-3561**  
SCHAEFFEL  
85 mm

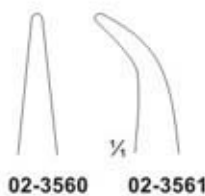

**02-3562**  
DOYEN  
110 mm



**02-3563**  
DOYEN  
180 mm

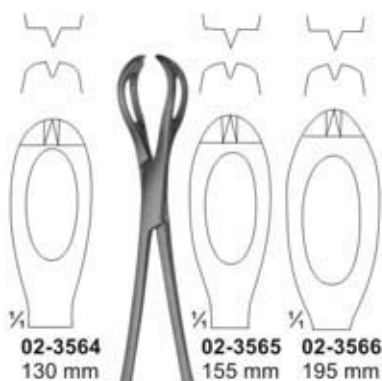

**02-3564**  
130 mm

**02-3565**  
155 mm

**02-3566**  
195 mm

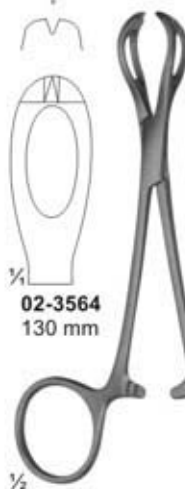

**02-3564 - 02-3566**  
LANE



**02-3567 - 02-3568**  
BACKHAUS

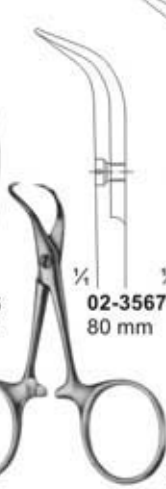

**02-3569 - 02-3571**  
BACKHAUS

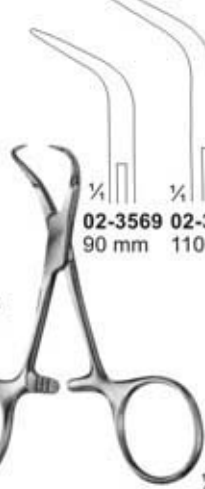

**02-3572**  
BACKHAUS-KOCHER  
135 mm



**02-3573**  
ROEDER  
160 mm

# MICRO SURGERY



**02-3574**  
ROBIN  
with holders for tubing  
up to 13 mm  
135 mm



**02-3575**  
with clip for tubing  
up to 15 mm  
110 mm



**02-3576**  
LORNA  
non perforating  
130 mm



**02-3577**  
for paper cloths  
140 mm



**02-3578**  
BUNT  
105 mm



**02-3579**  
MAYO  
140 mm

## Closing force



**02-3580**  
Straight  
50g



**02-3581**  
80g



**02-3582**  
Curved  
50g



**02-3583**  
80g



**02-3584**  
Curved tips  
50g



**02-3585**  
80g



**02-3586**  
Angled  
Shaped  
50g



**02-3587**  
80g



**02-3588**  
Muller  
Knee-bent  
50g



**02-3589**  
80g



**02-3590**  
Muller  
Ligature Forceps



Jaw, cross  
serrated  
Jaws profiles  
finally cross-  
serrated.

## Non-traumatic vessel clips, temporary.



**02-3591**  
38 mm  
48 mm



**02-3592**  
38 mm  
48 mm



**02-3593**  
58 mm



**02-3594**  
58 mm



**02-3595 - 02-3601**

02-3595 38 mm  
02-3596 48 mm  
02-3597 56 mm  
02-3598 63 mm  
02-3599 70 mm  
02-3600 80 mm  
02-3601 91 mm



**02-3602**  
DE BAKEY-  
HESS  
Length of  
Jaws 20 mm

# MICRO SURGERY



**02-3603**  
35 mm



**02-3604**  
35 mm



**02-3605**  
45 mm



**02-3606**  
45 mm



DE BAKEY

**02-3607**  
Length  
50 mm  
Jaws  
27 mm



DE BAKEY

**02-3608**  
Length  
48 mm  
Jaws  
27 mm



**02-3609**  
GLOVER  
Length  
57 mm  
Jaws 35 mm



**02-3610**  
DE BAKEY  
Length 73 mm  
Jaws 38 mm

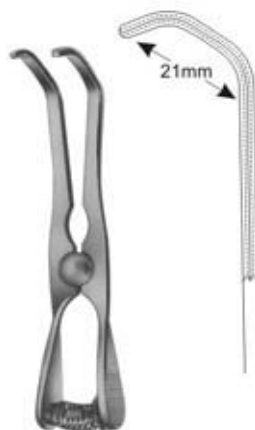

**02-3611**  
DE BAKEY  
Length 99 mm  
Jaws 63 mm



**02-3612**  
DE BAKEY  
Length 95 mm  
Jaws 54 mm



DE BAKEY

	Total length	Length of jaw
<b>02-3613</b>	80mm	25mm
<b>02-3614</b>	90mm	35mm
<b>02-3615</b>	105mm	50mm
<b>02-3616</b>	124mm	68mm



DE BAKEY

	Total length	Length of jaw
<b>02-3617</b>	78mm	25mm
<b>02-3618</b>	86mm	35mm
<b>02-3619</b>	97mm	50mm
<b>02-3620</b>	114mm	68mm



GLOVER

	Total length	Length of jaw
<b>02-3621</b>	68mm	33mm
<b>02-3622</b>	96mm	50mm
<b>02-3623</b>	117mm	69mm



GLOVER

	Total length	Length of jaw
<b>02-3624</b>	65mm	33mm
<b>02-3625</b>	91mm	50mm
<b>02-3626</b>	110mm	69mm

# MICRO SURGERY

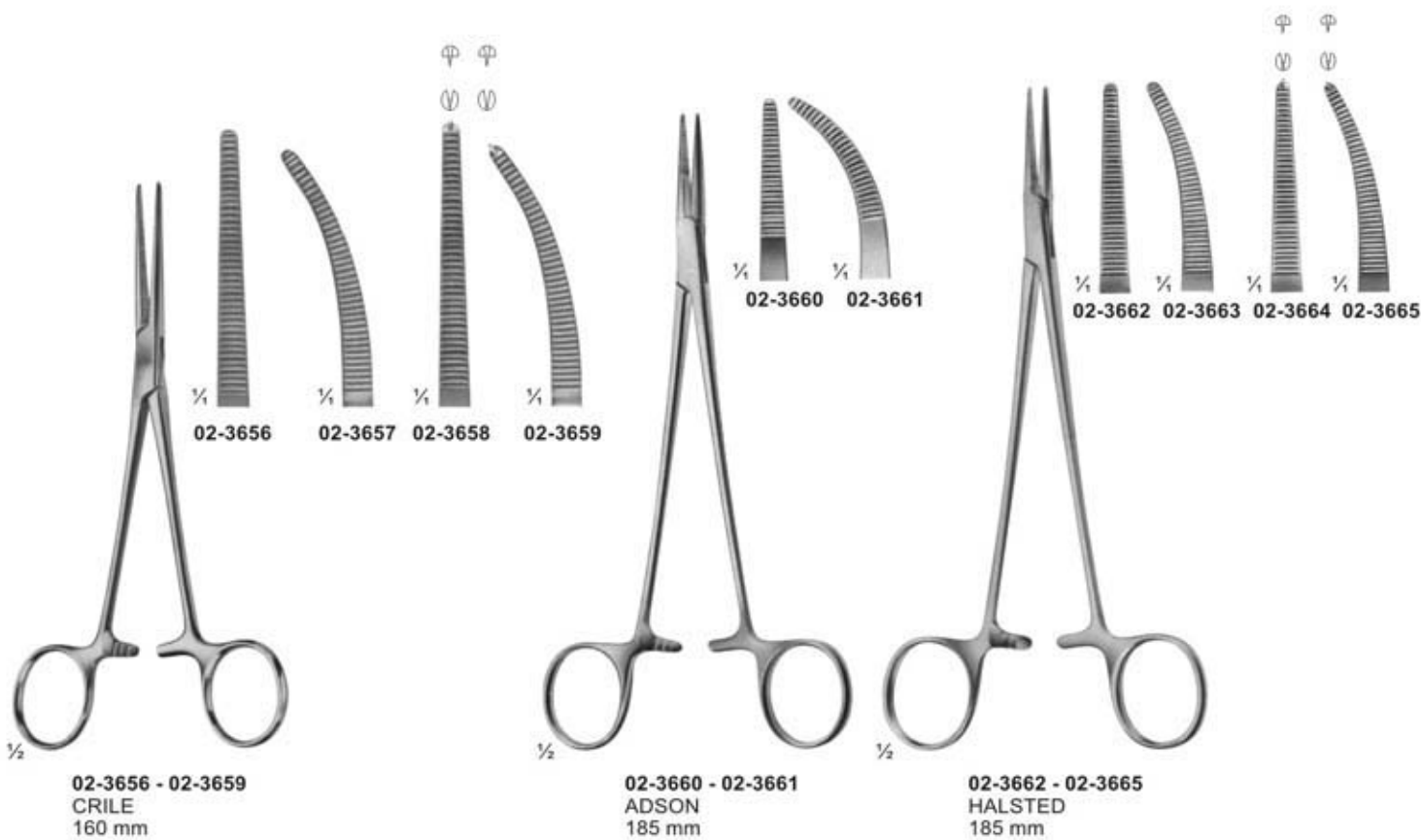
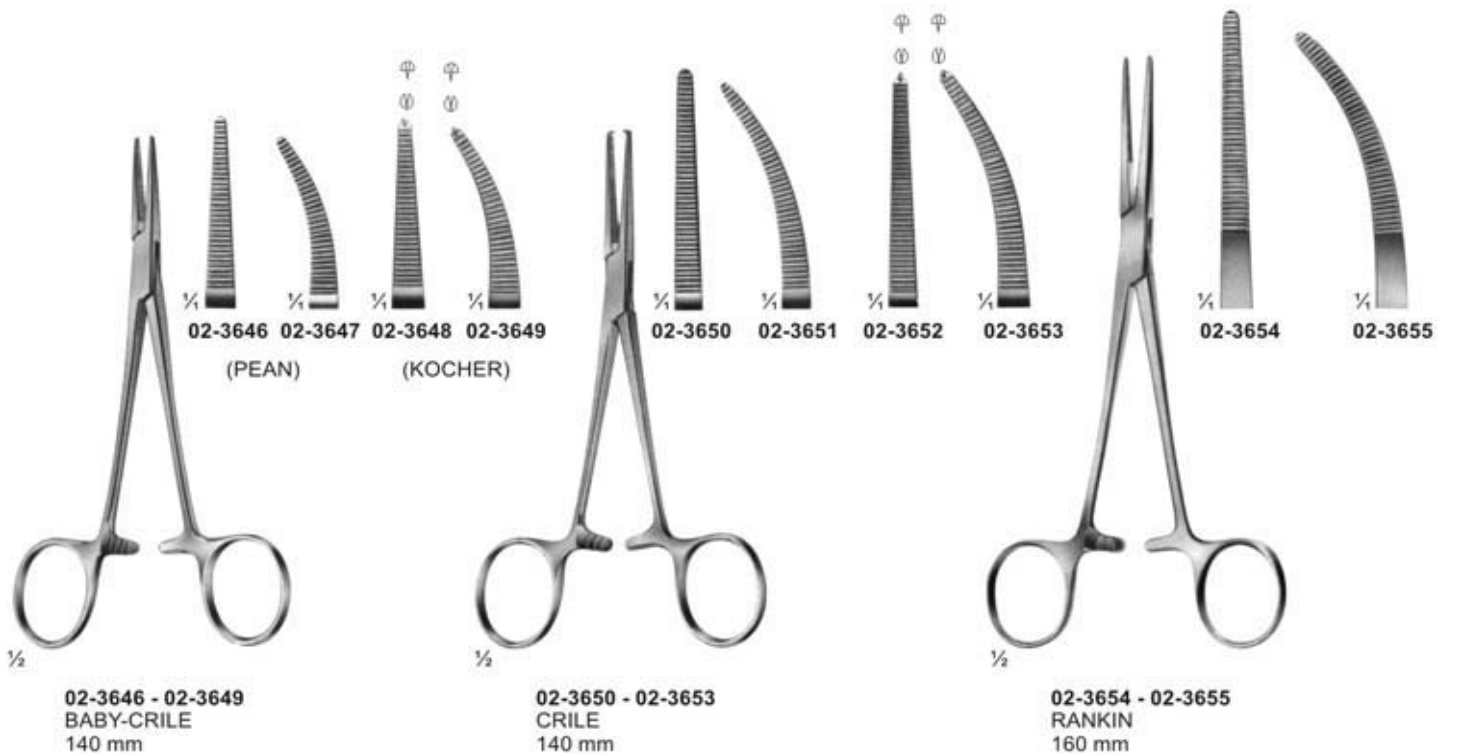

# MICRO SURGERY

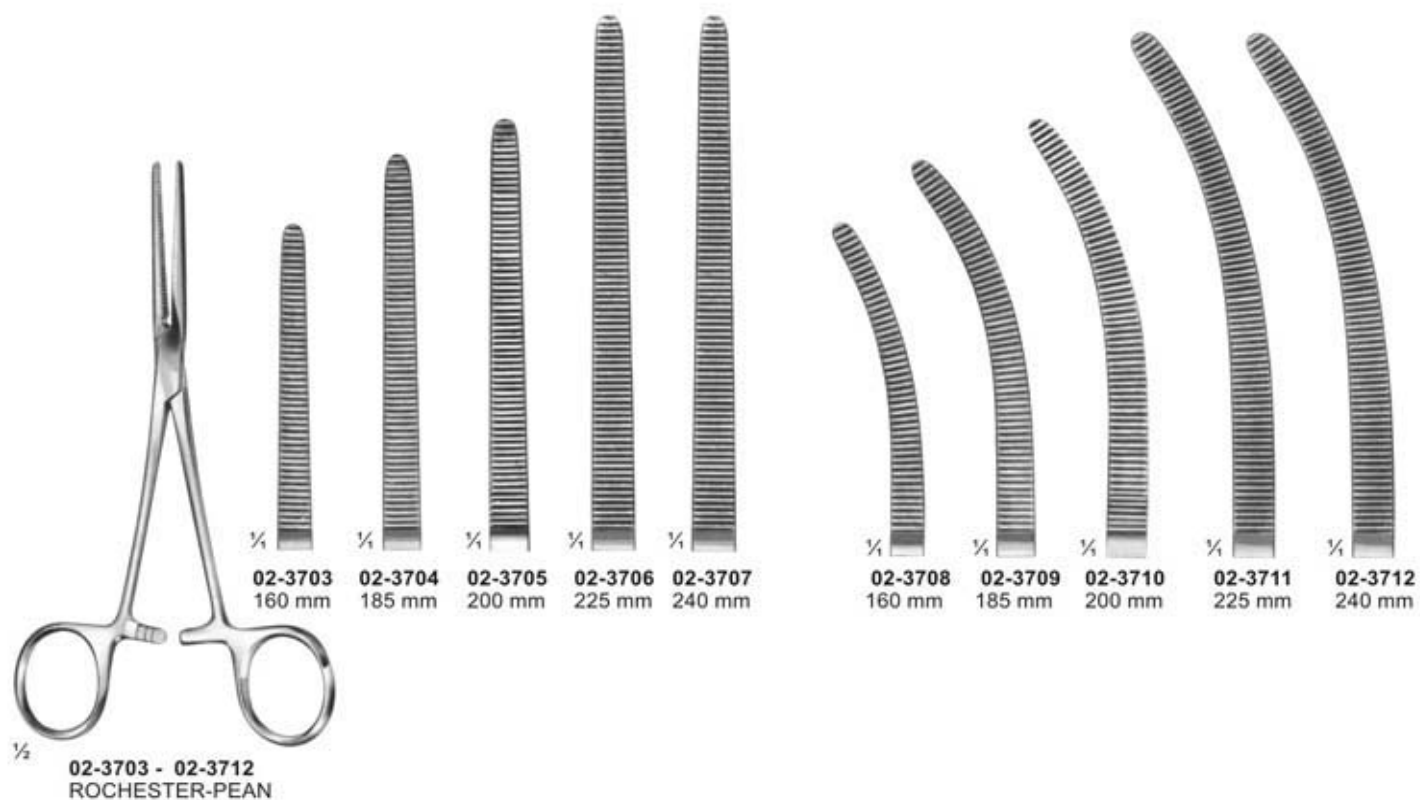
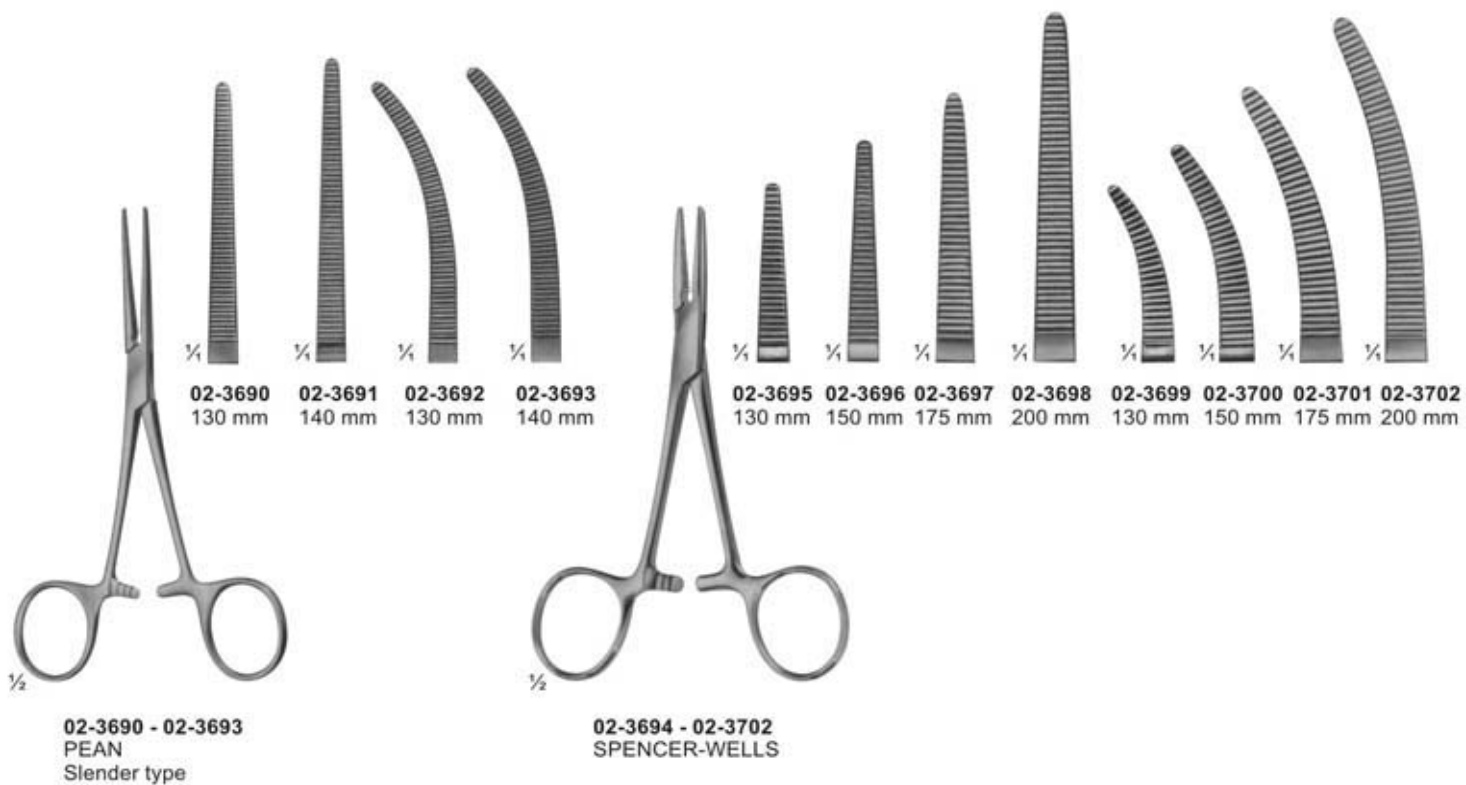

# MICRO SURGERY



02-3737 - 02-3740  
ROCHESTER-CARMALT

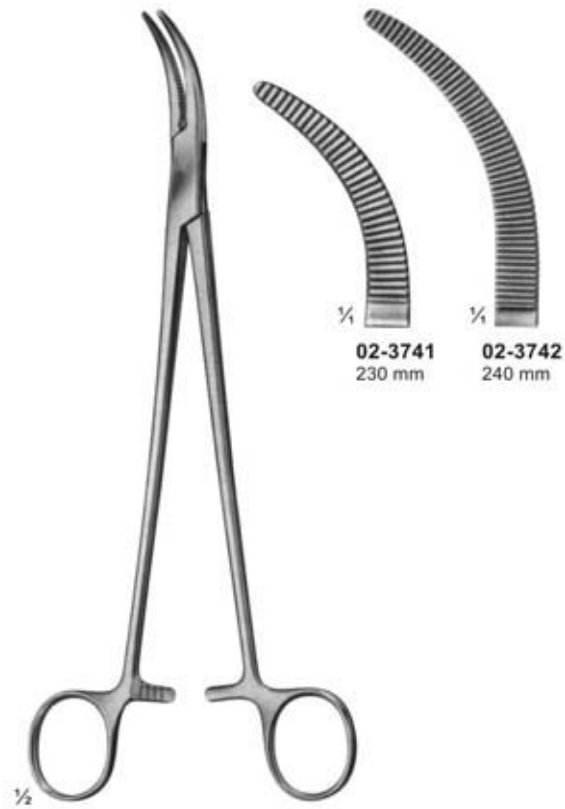

02-3741 - 02-3742  
MOYNIHAN

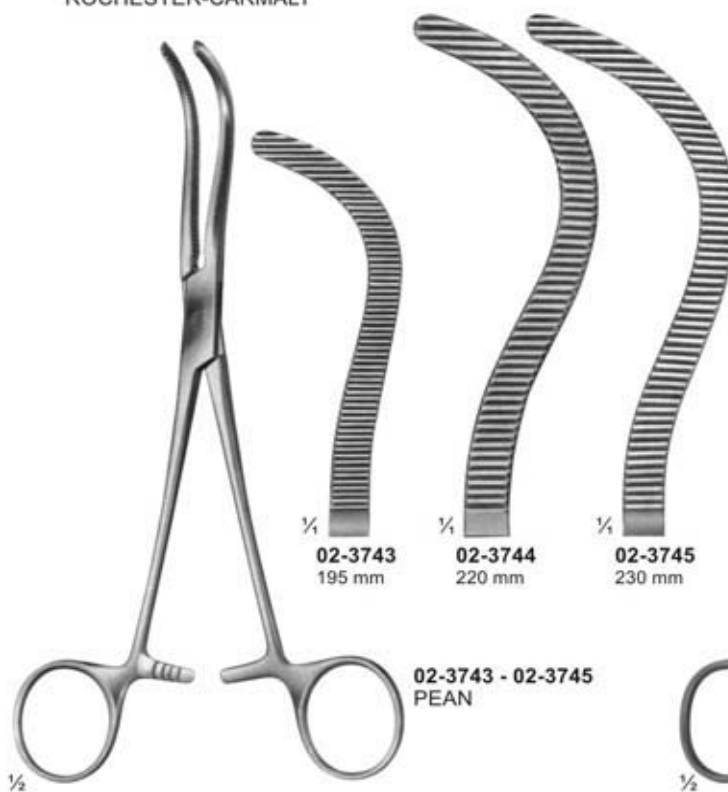

02-3743 - 02-3745  
PEAN

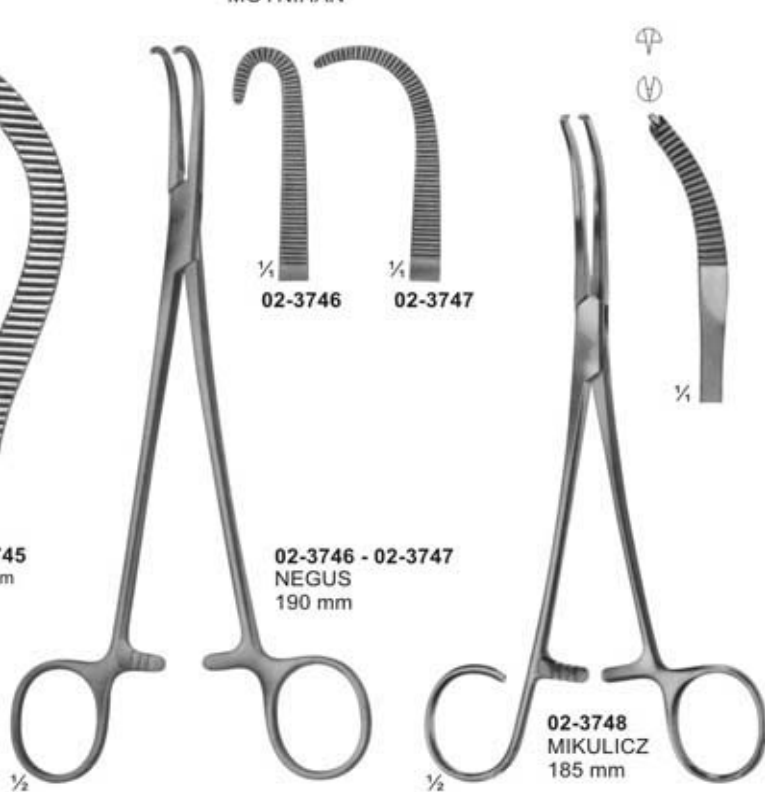

02-3746 - 02-3747  
NEGUS  
190 mm

02-3748  
MIKULICZ  
185 mm

# MICRO SURGERY



**02-3749**  
MICRO-ADSON  
140 mm



**02-3750**  
BABY-OVERHOLT  
135 mm



**02-3751** 140 mm  
**02-3752** 180 mm

**02-3751 - 02-3752**  
BABY-MIXTER



**02-3753** 140 mm  
**02-3754** 180 mm

**02-3753 - 02-3754**  
BABY-ADSON



**02-3755**  
185 mm

**02-3755**  
NISSEN



**02-3756**

**02-3757**

**02-3756 - 02-3757**  
YASARGIL  
195 mm



**02-3758**  
205 mm

**02-3758**  
OVERHOLT-MIXTER

# MICRO SURGERY



# MICRO SURGERY



**02-3799**  
BABY-MIKULICZ  
140 mm



**02-3800**  
MIKULICZ  
185 mm

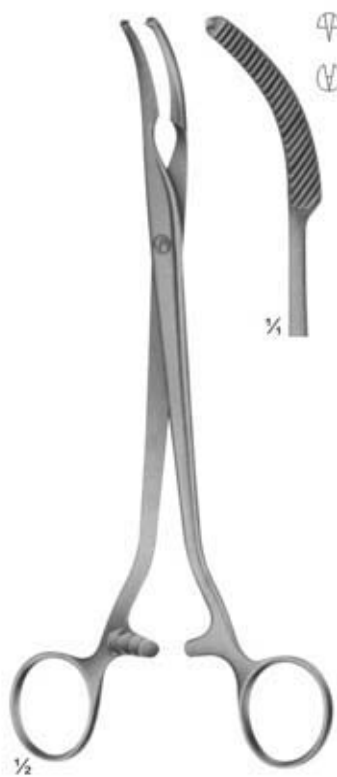

**02-3801**  
MIKULICZ  
205 mm



**02-3802**  
MIKULICZ  
200 mm



**02-3803**  
MIKULICZ  
205 mm

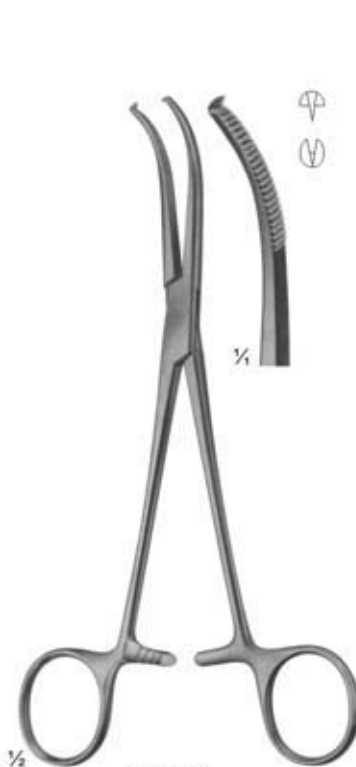

**02-3804**  
MIKULICZ  
185 mm



**02-3805 - 02-3806**  
FAURE  
205 mm

# MICRO SURGERY

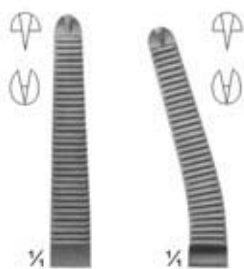

**02-3807**  
210 mm

**02-3808**  
205 mm

$\frac{1}{2}$   
**02-3807 - 02-3808**  
PHANEUF



$\frac{1}{4}$   
**02-3809**  
205 mm

$\frac{1}{4}$   
**02-3810**  
245 mm

$\frac{1}{2}$   
**02-3809 - 02-3810**  
HEANEY modif.



$\frac{1}{4}$   
**02-3811**  
195 mm

$\frac{1}{2}$   
**02-3811**  
HEANEY

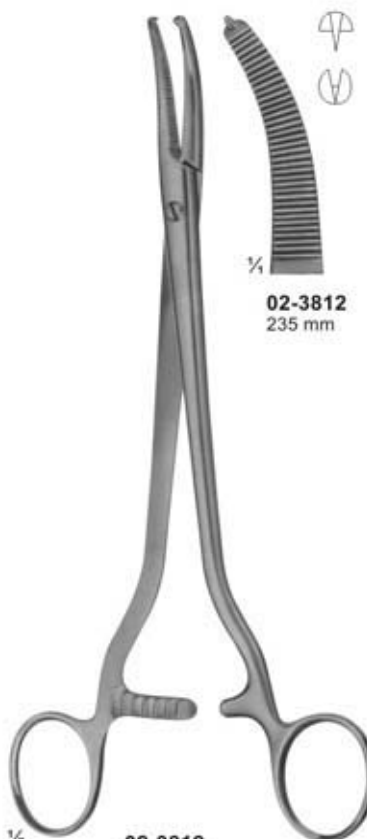

$\frac{1}{4}$   
**02-3812**  
235 mm

$\frac{1}{2}$   
**02-3812**  
WERTHEIM

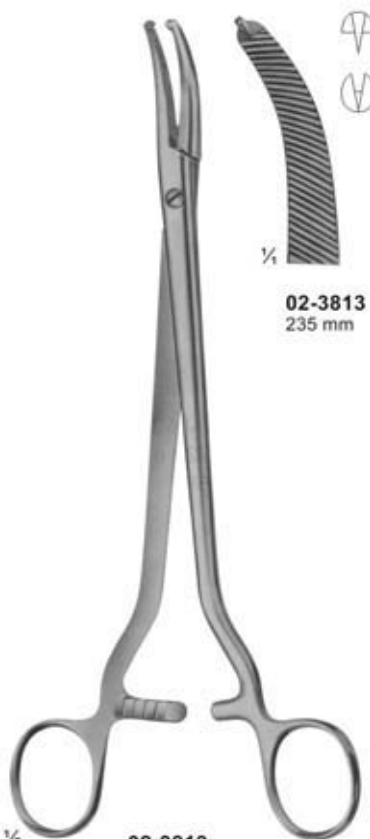

$\frac{1}{4}$   
**02-3813**  
235 mm

$\frac{1}{2}$   
**02-3813**  
WERTHEIM



$\frac{1}{4}$   
**02-3814**  
245 mm

$\frac{1}{2}$   
**02-3814**  
WERTHEIM



# CONTACT US

 +62 856-6381-381

 [inquiry@averonindonesia.com](mailto:inquiry@averonindonesia.com)

 [sales@averonindonesia.com](mailto:sales@averonindonesia.com)

 [www.averonindonesia.com](http://www.averonindonesia.com)

 Axa tower - Kuningan City Lt 45-7A Jl Prof. DR. Satrio, Kuningan, Kecamatan Setiabudi, Kota Jakarta Selatan, Daerah Khusus Ibukota Jakarta 12940.